

evanston public library



EVANSTON PUBLIC LIBRARY BOARD OF TRUSTEES

LIBRARY BOARD MEETING PACKET

Wednesday, May 17, 2023

6:30 pm

Main Library, Community Meeting Room and via Zoom

Remote Access Information

The Board of Trustees of the Evanston Public Library will hold its monthly meeting remotely. There are two ways to access the meeting, and it's pretty simple: on your computer or a phone.

Evanston Public Library is inviting you to a scheduled Zoom meeting.

Topic: EPL Regular Board Meeting

Time: May 17, 2023 6:30 PM Central Time (US and Canada)

Join Zoom Meeting

<https://us06web.zoom.us/j/87565216769>

+1 312 626 6799(Chicago) is the closest number.

The full list of US numbers:

- +1 3126266799 (Chicago)
- +1 6465588656 (New York)
- +1 3017158592 (Washington D.C.)
- +1 3462487799 (Houston)
- +1 6699009128 (San Jose)
- +1 2532158782 (Tacoma)

Please sign up to provide public comment by phone or video during the meeting by completing this google form: <https://forms.gle/ENo3s6XsH1X1pRdu5>

Zoom Tips

- Proper etiquette for virtual meetings is to mute your microphone unless you are talking. This makes it much easier for everyone else to hear and eliminates background noise.
- If you are connecting with a computer, your microphone is automatically muted.
- If you are connecting with a phone, please mute your audio.
- This meeting will be recorded (video and audio) as required by law.



EVANSTON PUBLIC LIBRARY BOARD OF TRUSTEES

Wednesday, May 17, 2023

Meeting of the Board

6:30 PM

In person and virtual

Members of the public are invited to provide comments in-person during the Public Comment portion of the meeting or by submitting written comments in advance via the following link: <https://forms.gle/ENo3s6XsH1X1pRdu5>
Written comments will be attached to the Board minutes and distributed to Trustees.

AGENDA

- 1. CALL TO ORDER / DECLARATION OF QUORUM**
- 2. LAND ACKNOWLEDGMENT**
- 3. CITIZEN COMMENT**
Not to exceed 45 minutes
- 4. CONSENT AGENDA**
 - A. Approval of Minutes April 19, 2023 Subcommittee and Regular Board Meeting**
 - B. Approval of Minutes May 2, 2023 Subcommittee Meeting**
 - B. Approval of Bills and Payroll**
- 5. EQUITY, DIVERSITY AND INCLUSION**
 - A. Racial Equity Task Force (Distributed in Advance)**
- 6. LIBRARY DIRECTOR'S REPORT (Distributed in Advance)**
- 7. STAFF REPORTS**
Administrative Services Report (Distributed in Advance)
- 8. BOARD REPORTS**
 - A. Development Committee**
 - B. Endowment Investment Committee**
 - C. Executive Committee**
 - D. Management & Policy Committee**
 - E. Board Development Committee**
 - F. Facilities Committee**
Library Maintenance seeks approval for 2023 CIP 23-07 480031 Mail Library Heating Boiler Replacement to Anchor Mechanical in the amount of \$546,975.
 - G. Director Search Team (Action)**
 - 1. Director Search timeline**
 - 2. Director Search shared purpose statement**
 - 3. Director Search job profile**
- 9. UNFINISHED BUSINESS**
 - A. Nominating Committee slate of candidates (discussion)**
- 10. NEW BUSINESS**
 - A. Safety discussion**
- 11. ADJOURNMENT**

Next Meeting: June 21 at 6:30 pm: in person and virtual

The City of Evanston and the Evanston Public Library are committed to ensuring accessibility for all citizens. If an accommodation is needed to participate in this meeting, please contact the Library at 847-448-8650 or TDD/TTY number 847-866-5095 at least 48 hours in advance of the meeting so that arrangements can be made for the accommodation if possible.



MEETING MINUTES
EVANSTON PUBLIC LIBRARY BOARD OF TRUSTEES
Wednesday, April 19, 2023
Subcommittee Meeting
12:30 PM
Remote via Zoom

Members Present

Tracy Fulce, Arikpo Dada, Meghan Shea, Benjamin Schapiro, Russ Shubet, Terry Soto and Esther Wallen **Shea was not sworn in yet.*

Members Absent

Margaret Lurie and Shawn Iles

Staff Present

Heather Norborg

Presiding Member

Tracy Fulce, President

Call to order/Declaration of Quorum

President Fulce called the meeting to order when a quorum of Trustees was established at 12:35 p.m.

Citizen Comment

None

Special Order of Business

Search Firm Review

Adjournment

The motion to adjourn was made by Trustee Soto and seconded by Trustee Fulce and approved by voice vote. The meeting adjourned at 1:53 p.m.

Submitted by: Terry Soto



MEETING MINUTES
EVANSTON PUBLIC LIBRARY BOARD OF TRUSTEES
Tuesday, May 2, 2023
Subcommittee Meeting
3:00 PM
Remote via Zoom

Members Present

Tracy Fulce, Arikpo Dada, Margaret Lurie, Benjamin Schapiro, Meghan Shea, Russ Shubet, and Terry Soto

Members Absent

Shawn Iles and Esther Wallen

Staff Present

Heather Norborg

Presiding Member

Tracy Fulce, President

Call to order/Declaration of Quorum

President Fulce called the meeting to order when a quorum of Trustees was established at 3:04 p.m.

Citizen Comment

None

Special Order of Business

Executive Director Search Committee Meeting

Adjournment

The motion to adjourn was made by Trustee Schapiro and seconded by Trustee Lurie and approved by voice vote. The meeting adjourned at 4:05 p.m.

Submitted by: Terry Soto



MEETING MINUTES
EVANSTON PUBLIC LIBRARY BOARD OF TRUSTEES
Wednesday, April 19, 2023
Meeting of the Board
6:30 PM
Main Library, Community Meeting Room and Remote

Members Present

Tracy Fulce, Arikpo Dada, Shawn Iles, Margaret Lurie, Benjamin Schapiro, Russ Shubet, Terry Soto and Esther Wallen. **Shea is sworn in after Roll Call.*

Members Absent

none

Staff Present

Heather Norborg, Jan Bojda, Jill Skwerski, John Devaney, Lea Hernandez-Solis and Wynn Shawver

Presiding Member

Tracy Fulce, President

Call to order/Declaration of Quorum

President Fulce called the meeting to order when a quorum of Trustees was established at 6:33 p.m.

Citizen Comment

none

Consent Agenda

- A. Approval of the Bills and Payroll and Minutes of the March 15, 2023 Board Meeting. Upon motion made by Trustee Schapiro and seconded by Trustee Lurie, the consent agenda was approved.

Equity, Diversity and Inclusion (Joint Task Force):

- A. Racial Equity Task Force (Distributed in Advance)

Library Director's Report

Written report provided in advance.

Staff Report:

Administrative Services Report (Distributed in Advance).

Board Reports:

- A. Development Committee
- B. Endowment Investment Committee

- C. Executive Committee
- D. Management & Policy Committee
- E. Board Development Committee
- F. Facilities Committee
 - A. Upon the motion made by Trustee Schapiro and seconded by Trustee Wallen, approve library maintenance seeks CIP project 480032 Bid 23-06 "Main Library LED Lighting Upgrade" to be awarded to Verde Energy Experts in the amount of \$225,500.
 - B. Upon the motion made by Trustee Shapiro and seconded by Trustee Soto, approve library maintenance seeks approval for the Compass Concrete estimate of \$43,800 for emergency masonry restoration to the Main library entranceway necessary after the February 2023 sewer collapse.
- G. Transition Team/Interim Team/Search Team

Unfinished Business

- A. Upon the motion made by Trustee Wallen and seconded by Trustee Schapiro, approve the Alma executive search contract for \$51, 675. ***Dada was absent for roll call of board action; *Shea left the meeting at 7:11pm.*

New Business

- A. Appointment of Nominating Committee
- B. Facilities Policy (Discussion)

Adjournment

The motion to adjourn was made by Trustee Schapiro and seconded by Trustee Lurie and approved by voice vote. The meeting adjourned at 7:47 p.m.

Submitted by: Terry Soto



Memorandum

To: Evanston Public Library Board of Trustees
Heather Norborg, Interim Executive Director

From: Lea Hernandez-Solis, Office Coordinator
Tera Davis, Accounts Payable Coordinator

Subject: Library Fund Bills

Date: May 11, 2023

Recommended Action

Staff and the Finance Committee recommend Library Board approval of the Library Payroll and Fund bills list.

Payroll

April 10, 2023 through April 23, 2023	\$ 158,928.76
April 24, 2023 through May 7, 2023	\$ 168,915.61

Library Fund Bills List

April 25, 2023	\$ 152,757.51
May 9, 2023	\$ 90,358.54

Attachement: Bills List

Library Bills List

G/L Date Range 04/25/23 - 04/25/23

Vendor	Invoice Description	Invoice Date	G/L Date	Payment Date	Invoice Amount	
Fund 185 - LIBRARY FUND						
Department 48 - LIBRARY						
Business Unit 4805 - EARLY LEARNING & LITERACY						
Account 62506 - WORK- STUDY						
10407 - NORTHWESTERN UNIVERSITY	WORK-STUDY WINTER QUARTER INVOICE	04/10/2023	04/25/2023	04/25/2023	78.75	
Account 62506 - WORK- STUDY Totals					Invoice Transactions 1	78.75
Account 65100 - LIBRARY SUPPLIES						
19563 - ELIZABETH STEIMLE	PROGRAM SUPPLIES REIMBURSEMENT	04/19/2023	04/25/2023	04/25/2023	135.00	
Account 65100 - LIBRARY SUPPLIES Totals					Invoice Transactions 1	135.00
Account 65630 - LIBRARY BOOKS						
100474 - BAKER & TAYLOR	JUV AND CROWN PRINT	04/17/2023	04/25/2023	04/25/2023	1,047.69	
100474 - BAKER & TAYLOR	JUV AND CROWN PRINT	04/11/2023	04/25/2023	04/25/2023	1,441.45	
100474 - BAKER & TAYLOR	JUV AND ADULT PRINT	04/13/2023	04/25/2023	04/25/2023	410.13	
100474 - BAKER & TAYLOR	MAIN JUV PRINT	04/14/2023	04/25/2023	04/25/2023	1,031.51	
100474 - BAKER & TAYLOR	JUV PRINT	04/14/2023	04/25/2023	04/25/2023	232.46	
100474 - BAKER & TAYLOR	JUV AND CROWN PRINT	04/15/2023	04/25/2023	04/25/2023	1,260.90	
100474 - BAKER & TAYLOR	JUV AND CROWN PRINT	04/13/2023	04/25/2023	04/25/2023	120.45	
100474 - BAKER & TAYLOR	JUV AND CROWN PRINT	03/28/2023	04/25/2023	04/25/2023	910.32	
Account 65630 - LIBRARY BOOKS Totals					Invoice Transactions 8	6,454.91
Account 65641 - AUDIO VISUAL COLLECTIONS						
103424 - MIDWEST TAPE LLC	JUV AV	04/05/2023	04/25/2023	04/25/2023	40.93	
103424 - MIDWEST TAPE LLC	JUV AV	04/05/2023	04/25/2023	04/25/2023	92.15	
19521 - PLAYAWAY PRODUCTS LLC	JUV AV	04/05/2023	04/25/2023	04/25/2023	357.93	
19521 - PLAYAWAY PRODUCTS LLC	JUV AV	04/12/2023	04/25/2023	04/25/2023	129.46	
19521 - PLAYAWAY PRODUCTS LLC	JUV AV	03/21/2023	04/25/2023	04/25/2023	125.21	
19521 - PLAYAWAY PRODUCTS LLC	JUV AV	03/24/2023	04/25/2023	04/25/2023	270.95	
Account 65641 - AUDIO VISUAL COLLECTIONS Totals					Invoice Transactions 6	1,016.63
Business Unit 4805 - EARLY LEARNING & LITERACY Totals					Invoice Transactions 16	7,685.29
Business Unit 4806 - LIFELONG LEARNING & LITERACY						
Account 62341 - INTERNET SOLUTION PROVIDERS						
16334 - KANOPY	MAIN ADULT ONLINE RESOURCES	03/31/2023	04/25/2023	04/25/2023	1,476.00	
103424 - MIDWEST TAPE LLC	MAIN ADULT ONLINE RESOURCES	03/31/2023	04/25/2023	04/25/2023	4,499.72	
Account 62341 - INTERNET SOLUTION PROVIDERS Totals					Invoice Transactions 2	5,975.72
Account 65630 - LIBRARY BOOKS						
100474 - BAKER & TAYLOR	ADULT AND CROWN PRINT	04/07/2023	04/25/2023	04/25/2023	953.58	
100474 - BAKER & TAYLOR	ADULT PRINT	04/10/2023	04/25/2023	04/25/2023	130.30	
100474 - BAKER & TAYLOR	ADULT AND CROWN PRINT	04/12/2023	04/25/2023	04/25/2023	1,351.95	
100474 - BAKER & TAYLOR	ADULT AND CROWN PRINT	04/14/2023	04/25/2023	04/25/2023	488.82	
100474 - BAKER & TAYLOR	ADULT AND CROWN PRINT	04/14/2023	04/25/2023	04/25/2023	408.73	
100474 - BAKER & TAYLOR	ADULT PRINT	04/14/2023	04/25/2023	04/25/2023	303.00	
100474 - BAKER & TAYLOR	ADULT AND CROWN PRINT	04/14/2023	04/25/2023	04/25/2023	1,646.51	
100474 - BAKER & TAYLOR	ADULT AND CROWN PRINT	04/14/2023	04/25/2023	04/25/2023	420.06	
100474 - BAKER & TAYLOR	ADULT PRINT	04/11/2023	04/25/2023	04/25/2023	292.61	
100474 - BAKER & TAYLOR	ADULT AND CROWN PRINT	03/31/2023	04/25/2023	04/25/2023	550.53	
100474 - BAKER & TAYLOR	ADULT PRINT	03/31/2023	04/25/2023	04/25/2023	238.62	
100474 - BAKER & TAYLOR	ADULT PRINT	03/23/2023	04/25/2023	04/25/2023	108.90	
100474 - BAKER & TAYLOR	ADULT AND CROWN PRINT	03/29/2023	04/25/2023	04/25/2023	176.76	
100474 - BAKER & TAYLOR	ADULT PRINT	04/05/2023	04/25/2023	04/25/2023	99.35	
100474 - BAKER & TAYLOR	ADULT PRINT	04/04/2023	04/25/2023	04/25/2023	144.60	
100474 - BAKER & TAYLOR	CROWN PRINT	04/05/2023	04/25/2023	04/25/2023	329.19	
100474 - BAKER & TAYLOR	ADULT PRINT	04/06/2023	04/25/2023	04/25/2023	98.46	
120319 - CENGAGE LEARNING INC./GALE RESEARCH	ADULT PRINT	04/05/2023	04/25/2023	04/25/2023	51.73	
120319 - CENGAGE LEARNING INC./GALE RESEARCH	MSO PRINT	03/22/2023	04/25/2023	04/25/2023	22.50	
276974 - OVER DRIVE, INC.	MAIN ADULT EBOOKS	03/31/2023	04/25/2023	04/25/2023	382.47	
276974 - OVER DRIVE, INC.	MAIN ADULT EBOOKS	03/31/2023	04/25/2023	04/25/2023	92.33	
276974 - OVER DRIVE, INC.	MAIN ADULT EBOOKS	03/31/2023	04/25/2023	04/25/2023	718.17	
276974 - OVER DRIVE, INC.	MAIN ADULT EBOOKS	03/31/2023	04/25/2023	04/25/2023	781.06	
276974 - OVER DRIVE, INC.	MAIN ADULT EBOOKS	03/28/2023	04/25/2023	04/25/2023	580.06	
276974 - OVER DRIVE, INC.	MAIN ADULT EBOOKS	03/31/2023	04/25/2023	04/25/2023	359.84	
276974 - OVER DRIVE, INC.	MAIN ADULT EBOOKS	03/21/2023	04/25/2023	04/25/2023	463.65	
276974 - OVER DRIVE, INC.	MAIN ADULT EBOOKS	03/24/2023	04/25/2023	04/25/2023	178.48	
276974 - OVER DRIVE, INC.	MAIN ADULT EBOOKS	03/24/2023	04/25/2023	04/25/2023	571.28	
276974 - OVER DRIVE, INC.	MAIN ADULT EBOOKS	04/14/2023	04/25/2023	04/25/2023	304.25	

276974 - OVER DRIVE, INC.	MAIN ADULT EBOOKS	04/14/2023	04/25/2023	04/25/2023	56.82
276974 - OVER DRIVE, INC.	MAIN ADULT EBOOKS	04/14/2023	04/25/2023	04/25/2023	2,099.38
276974 - OVER DRIVE, INC.	MAIN ADULT EBOOKS	03/24/2023	04/25/2023	04/25/2023	75.78
276974 - OVER DRIVE, INC.	MAIN ADULT EBOOKS	03/24/2023	04/25/2023	04/25/2023	585.71
276974 - OVER DRIVE, INC.	MAIN ADULT EBOOKS	04/07/2023	04/25/2023	04/25/2023	693.32
276974 - OVER DRIVE, INC.	MAIN ADULT EBOOKS	04/07/2023	04/25/2023	04/25/2023	156.01
276974 - OVER DRIVE, INC.	MAIN ADULT EBOOKS	04/07/2023	04/25/2023	04/25/2023	90.49
276974 - OVER DRIVE, INC.	MAIN ADULT EBOOKS	04/07/2023	04/25/2023	04/25/2023	1,160.90
Account 65630 - LIBRARY BOOKS Totals Invoice Transactions 37					\$17,166.20

Account 65641 - AUDIO VISUAL COLLECTIONS

100474 - BAKER & TAYLOR	ADULT AV	04/03/2023	04/25/2023	04/25/2023	93.19
103424 - MIDWEST TAPE LLC	ADULT AV	04/12/2023	04/25/2023	04/25/2023	12.57
103424 - MIDWEST TAPE LLC	ADULT AV	04/12/2023	04/25/2023	04/25/2023	66.19
103424 - MIDWEST TAPE LLC	ADULT AV	04/12/2023	04/25/2023	04/25/2023	24.43
103424 - MIDWEST TAPE LLC	ADULT AV	04/12/2023	04/25/2023	04/25/2023	80.04
103424 - MIDWEST TAPE LLC	ADULT AV	04/12/2023	04/25/2023	04/25/2023	133.40
103424 - MIDWEST TAPE LLC	ADULT AV	04/12/2023	04/25/2023	04/25/2023	115.01
103424 - MIDWEST TAPE LLC	ADULT AV	04/05/2023	04/25/2023	04/25/2023	190.90
103424 - MIDWEST TAPE LLC	ADULT AV	03/22/2023	04/25/2023	04/25/2023	88.72
103424 - MIDWEST TAPE LLC	ADULT AV	03/22/2023	04/25/2023	04/25/2023	54.86
103424 - MIDWEST TAPE LLC	ADULT AV	03/22/2023	04/25/2023	04/25/2023	53.36
103424 - MIDWEST TAPE LLC	ADULT AV	03/22/2023	04/25/2023	04/25/2023	62.44
103424 - MIDWEST TAPE LLC	JUV AV	03/22/2023	04/25/2023	04/25/2023	62.29
103424 - MIDWEST TAPE LLC	ADULT AV	03/22/2023	04/25/2023	04/25/2023	308.88
103424 - MIDWEST TAPE LLC	ADULT AV	03/29/2023	04/25/2023	04/25/2023	24.43
103424 - MIDWEST TAPE LLC	ADULT AV	03/29/2023	04/25/2023	04/25/2023	43.61
103424 - MIDWEST TAPE LLC	ADULT AV	03/29/2023	04/25/2023	04/25/2023	31.22
Account 65641 - AUDIO VISUAL COLLECTIONS Totals Invoice Transactions 17					\$1,445.54
Business Unit 4806 - LIFELONG LEARNING & LITERACY Totals Invoice Transactions 56					\$24,587.46

Business Unit 4820 - ACCESS SERVICES

Account 62341 - INTERNET SOLUTION PROVIDERS

19589 - MOBILE BEACON	REPLACEMENT HOTSPOTS REF NUMBER: MB- 158607	04/21/2023	04/25/2023	04/25/2023	2,912.00
Account 62341 - INTERNET SOLUTION PROVIDERS Totals Invoice Transactions 1					\$2,912.00

Account 62506 - WORK- STUDY

10407 - NORTHWESTERN UNIVERSITY	WORK-STUDY WINTER QUARTER INVOICE	04/10/2023	04/25/2023	04/25/2023	616.73
Account 62506 - WORK- STUDY Totals Invoice Transactions 1					\$616.73

Account 65100 - LIBRARY SUPPLIES

101406 - DEMCO, INC.	OFFICE SUPPLIES	04/06/2023	04/25/2023	04/25/2023	122.38
10893 - LUCAS COLOR CARD	LIBRARY CARDS QUOTE 13416302	04/18/2023	04/25/2023	04/25/2023	1,205.01
17642 - TEAM ONE REPAIR, INC.	BULK ORDER ADHESIVE LABEL PAPER ORDER#1423561	03/29/2023	04/25/2023	04/25/2023	2,340.00
121187 - UNIQUE MANAGEMENT SERVICES	COLLECTION SERVICES	04/01/2023	04/25/2023	04/25/2023	768.30
Account 65100 - LIBRARY SUPPLIES Totals Invoice Transactions 4					\$4,435.69

Business Unit 4820 - ACCESS SERVICES Totals Invoice Transactions 6

\$7,964.42

Business Unit 4825 - ENGAGEMENT SERVICES

Account 57551 - LIBRARY GRANTS

17049 - CHARLOTTA KOPPANYI	FACILITATOR IN-PERSON MEMORY CAFE	04/17/2023	04/25/2023	04/25/2023	100.00
Account 57551 - LIBRARY GRANTS Totals Invoice Transactions 1					\$100.00

Account 62340 - IT COMPUTER SOFTWARE

17077 - MURPHY SECURITY SOLUTIONS LLC	YEARLY MAINTENANCE RENEWAL	03/08/2023	04/25/2023	04/25/2023	2,695.00
Account 62340 - IT COMPUTER SOFTWARE Totals Invoice Transactions 1					\$2,695.00

Account 65100 - LIBRARY SUPPLIES

19593 - 3RD DIMENSION PERFORMANCE GROUP	PROFESSIONAL SERVICES	03/31/2023	04/25/2023	04/25/2023	2,500.00
100474 - BAKER & TAYLOR	ENGAGEMENT SUPPLIES	04/18/2023	04/25/2023	04/25/2023	64.52
100474 - BAKER & TAYLOR	ENGAGEMENT SUPPLIES	04/10/2023	04/25/2023	04/25/2023	231.88
100474 - BAKER & TAYLOR	ENGAGEMENT SUPPLIES	04/10/2023	04/25/2023	04/25/2023	947.43
19499 - DIME LLC	PROFESSIONAL SERVICES DEPOSIT	04/10/2023	04/25/2023	04/25/2023	125.00
16858 - JEANETTE MCCRAY	BABERING SERVICES	03/30/2023	04/25/2023	04/25/2023	150.00
206940 - ULINE	OFFICE SUPPLIES	03/17/2023	04/25/2023	04/25/2023	31.50

		Account 65100 - LIBRARY SUPPLIES Totals	Invoice Transactions 7		\$4,050.33
Account 65630 - LIBRARY BOOKS					
100474 - BAKER & TAYLOR	JUV AND CROWN PRINT	04/17/2023	04/25/2023	04/25/2023	12.42
100474 - BAKER & TAYLOR	ADULT AND CROWN PRINT	04/07/2023	04/25/2023	04/25/2023	31.64
100474 - BAKER & TAYLOR	JUV AND CROWN PRINT	04/11/2023	04/25/2023	04/25/2023	38.18
100474 - BAKER & TAYLOR	ADULT AND CROWN PRINT	04/12/2023	04/25/2023	04/25/2023	41.75
100474 - BAKER & TAYLOR	ADULT AND CROWN PRINT	04/14/2023	04/25/2023	04/25/2023	75.49
100474 - BAKER & TAYLOR	ADULT AND CROWN PRINT	04/14/2023	04/25/2023	04/25/2023	16.39
100474 - BAKER & TAYLOR	ADULT AND CROWN PRINT	04/14/2023	04/25/2023	04/25/2023	73.99
100474 - BAKER & TAYLOR	JUV AND CROWN PRINT	04/13/2023	04/25/2023	04/25/2023	36.88
100474 - BAKER & TAYLOR	ADULT AND CROWN PRINT	03/31/2023	04/25/2023	04/25/2023	43.50
100474 - BAKER & TAYLOR	JUV AND CROWN PRINT	03/28/2023	04/25/2023	04/25/2023	141.07
100474 - BAKER & TAYLOR	ADULT AND CROWN PRINT	03/29/2023	04/25/2023	04/25/2023	32.21
100474 - BAKER & TAYLOR	CROWN PRINT	04/05/2023	04/25/2023	04/25/2023	87.01
		Account 65630 - LIBRARY BOOKS Totals	Invoice Transactions 12		\$630.53
Account 65641 - AUDIO VISUAL COLLECTIONS					
103424 - MIDWEST TAPE LLC	ADULT AV	04/12/2023	04/25/2023	04/25/2023	60.72
		Account 65641 - AUDIO VISUAL COLLECTIONS Totals	Invoice Transactions 1		\$60.72
Business Unit 4825 - ENGAGEMENT SERVICES Totals					
		Business Unit 4825 - ENGAGEMENT SERVICES Totals	Invoice Transactions 22		\$7,536.58
Business Unit 4835 - INNOVATION & DIGITAL LEARNING					
Account 62341 - INTERNET SOLUTION PROVIDERS					
13657 - GLANTZ, INC	WEBSITE UPGRADE	04/05/2023	04/25/2023	04/25/2023	410.00
18932 - PATRON POINT, INC.	ONLINE RESOURCES	04/20/2023	04/25/2023	04/25/2023	104.70
		Account 62341 - INTERNET SOLUTION PROVIDERS Totals	Invoice Transactions 2		\$514.70
Account 65002 - STATE GRANT EXPENSE					
19640 - BRIAN JABLO	PROFESSIONAL SERVICES - MUSICIAN FEE	04/12/2023	04/25/2023	04/25/2023	150.00
18092 - LITERACY WORKS	PROFESSIONAL SERVICES	03/09/2023	04/25/2023	04/25/2023	2,100.00
		Account 65002 - STATE GRANT EXPENSE Totals	Invoice Transactions 2		\$2,250.00
Account 65100 - LIBRARY SUPPLIES					
19635 - TANAY SRIVASTAVA	PROFESSIONAL SERVICES - MUSICIAN FEE	04/12/2023	04/25/2023	04/25/2023	150.00
123471 - Todd Galvin	PROFESSIONAL SERVICES - MUSICIAN FEE	04/12/2023	04/25/2023	04/25/2023	150.00
		Account 65100 - LIBRARY SUPPLIES Totals	Invoice Transactions 2		\$300.00
Account 65630 - LIBRARY BOOKS					
100474 - BAKER & TAYLOR	JUV AND CROWN PRINT	04/13/2023	04/25/2023	04/25/2023	253.80
276974 - OVER DRIVE, INC.	MAIN YA EBOOKS	04/12/2023	04/25/2023	04/25/2023	112.97
276974 - OVER DRIVE, INC.	MAIN YA EBOOKS	04/12/2023	04/25/2023	04/25/2023	511.94
276974 - OVER DRIVE, INC.	MAIN YA EBOOKS	04/12/2023	04/25/2023	04/25/2023	125.36
276974 - OVER DRIVE, INC.	MAIN YA EBOOKS	04/12/2023	04/25/2023	04/25/2023	760.14
		Account 65630 - LIBRARY BOOKS Totals	Invoice Transactions 5		\$1,764.21
		Business Unit 4835 - INNOVATION & DIGITAL LEARNING Totals	Invoice Transactions 11		\$4,828.91
Business Unit 4840 - LIBRARY MAINTENANCE					
Account 62225 - BLDG MAINTENANCE SERVICES					
151986 - CINTAS CORPORATION #769	CARPET CLEANING	04/13/2023	04/25/2023	04/25/2023	510.13
151986 - CINTAS CORPORATION #769	CARPET CLEANING	04/12/2023	04/25/2023	04/25/2023	115.99
151986 - CINTAS CORPORATION #769	CARPET CLEANING	02/02/2023	04/25/2023	04/25/2023	510.13
151986 - CINTAS CORPORATION #769	CARPET CLEANING	01/26/2023	04/25/2023	04/25/2023	510.13
151986 - CINTAS CORPORATION #769	CARPET CLEANING	04/20/2023	04/25/2023	04/25/2023	510.13
101063 - CINTAS FIRST AID & SUPPLY	FIRST AID KIT SERVICE	04/18/2023	04/25/2023	04/25/2023	84.28
298493 - CONQUEST PEST SOLUTIONS	PEST CONTROL	04/10/2023	04/25/2023	04/25/2023	145.00
104595 - SCHINDLER ELEVATOR CORP	ELEVATOR SERVICE	03/28/2023	04/25/2023	04/25/2023	1,725.00
104729 - SIEMENS INDUSTRY, INC.	BUILDING AUTOMATION SERVICE AGREEMENT 2023	04/05/2023	04/25/2023	04/25/2023	27,711.08
145106 - TOTAL BUILDING SERVICES	JANITORIAL SERVICES 2023	04/03/2023	04/25/2023	04/25/2023	10,520.00
		Account 62225 - BLDG MAINTENANCE SERVICES Totals	Invoice Transactions 10		\$42,341.87
Account 62341 - INTERNET SOLUTION PROVIDERS					
137361 - COOPERATIVE COMPUTER SERVICES	CCS MEMBERSHIP FEE	04/15/2023	04/25/2023	04/25/2023	23,286.96
		Account 62341 - INTERNET SOLUTION PROVIDERS Totals	Invoice Transactions 1		\$23,286.96
Account 65040 - JANITORIAL SUPPLIES					
151986 - CINTAS CORPORATION #769	CARPET CLEANING	04/06/2023	04/25/2023	04/25/2023	510.13
10546 - SUPERIOR INDUSTRIAL SUPPLY	JANITORIAL SUPPLIES	04/19/2023	04/25/2023	04/25/2023	686.90
		Account 65040 - JANITORIAL SUPPLIES Totals	Invoice Transactions 2		\$1,197.03

Business Unit 4845 - LIBRARY ADMINISTRATION

Account 62185 - CONSULTING SERVICES

18957 - CHERIE ASANTE	EPL VOLUNTEER MANAGEMENT	04/20/2023	04/25/2023	04/25/2023	1,785.33
15403 - LAW OFFICES OF ANCEL, GLINK, DIAMOND, BUSH, DICIAN	PROFESSIONAL SERVICES	04/11/2023	04/25/2023	04/25/2023	115.00
12151 - MULTILINGUAL CONNECTIONS LLC	TRANSLATION SERVICES RELIEF CLINIC	04/07/2023	04/25/2023	04/25/2023	118.75
11982 - STEPHEN YOUNG	PIANO TUNING	04/17/2023	04/25/2023	04/25/2023	250.00

Account 62185 - CONSULTING SERVICES Totals Invoice Transactions 4

\$2,269.08

Account 62210 - PRINTING

14818 - FISHEYE GRAPHIC SERVICES, INC.	PRINTING BOOKMARKS	02/28/2023	04/25/2023	04/25/2023	130.00
102520 - ILLINOIS PAPER DBA IMPACT NETWORKING LLC	COPY PAPER QUOTE QT27480	04/13/2023	04/25/2023	04/25/2023	2,215.00

Account 62210 - PRINTING Totals Invoice Transactions 2

\$2,345.00

Account 62295 - TRAINING & TRAVEL

19493 - EVAN MATHER	TRAVEL REIMBURSEMENT C2E2 CONFERENCE	04/03/2023	04/25/2023	04/25/2023	39.91
18675 - KELLYE FLEMING	ALA CONFERENCE REGISTRATION REIMBURSEMENT	04/04/2023	04/25/2023	04/25/2023	240.00
18611 - KENNEDY JOSEPH	TRAVEL REIMBURSEMENT C2E2 CONFERENCE	04/10/2023	04/25/2023	04/25/2023	67.70
18836 - MORGAN PATTEN	TRAVEL REIMBURSEMENT C2E2 CONFERENCE	04/04/2023	04/25/2023	04/25/2023	42.55
19600 - OZIVELL ECFORD	TRAVEL REIMBURSEMENT CONFERENCE	03/27/2023	04/25/2023	04/25/2023	322.28
290975 - ROBIN R. SINDELAR	TRAVEL REIMBURSEMENT AIRFARE	04/04/2023	04/25/2023	04/25/2023	774.77

Account 62295 - TRAINING & TRAVEL Totals Invoice Transactions 6

\$1,487.21

Account 62315 - POSTAGE

10172 - LEA FARAH HERNANDEZ-SOLIS	BULK MAIL PERMIT FEE	04/21/2023	04/25/2023	04/25/2023	290.00
-----------------------------------	----------------------	------------	------------	------------	--------

Account 62315 - POSTAGE Totals Invoice Transactions 1

\$290.00

Account 62360 - MEMBERSHIP DUES

102512 - ILLINOIS LIBRARY ASSOCIATION	2023-2024 ILA INSTITUTIONAL MEMBERSHIP	04/18/2023	04/25/2023	04/25/2023	500.00
---------------------------------------	----------------------------------------	------------	------------	------------	--------

Account 62360 - MEMBERSHIP DUES Totals Invoice Transactions 1

\$500.00

Account 62506 - WORK- STUDY

10407 - NORTHWESTERN UNIVERSITY	WORK-STUDY WINTER QUARTER INVOICE	04/10/2023	04/25/2023	04/25/2023	366.38
---------------------------------	-----------------------------------	------------	------------	------------	--------

Account 62506 - WORK- STUDY Totals Invoice Transactions 1

\$366.38

Account 65095 - OFFICE SUPPLIES

105711 - 4IMPRINT, INC.	OFFICE SUPPLIES	04/14/2023	04/25/2023	04/25/2023	178.04
103883 - ODP BUSINESS SOLUTIONS, LLC	OFFICE SUPPLIES	04/06/2023	04/25/2023	04/25/2023	118.59
206940 - ULINE	DISPOSABLE FACE MASK BULK	03/27/2023	04/25/2023	04/25/2023	168.02

Account 65095 - OFFICE SUPPLIES Totals Invoice Transactions 3

\$464.65

Business Unit 4845 - LIBRARY ADMINISTRATION Totals Invoice Transactions 18

\$7,722.32

Department 48 - LIBRARY Totals Invoice Transactions 142

\$127,150.84

Fund 185 - LIBRARY FUND Totals Invoice Transactions 142

\$127,150.84

Fund 187 - LIBRARY CAPITAL IMPROVEMENT FD

Department 48 - LIBRARY

Business Unit 4862 - LIBRARY CAPITAL IMPROVEMENT

Account 65515 - OTHER IMPROVEMENTS

167918 - JOEL KENNEDY CONSTRUCTION CORPORATION	EMERGENCY WORK SERVICE	04/05/2023	04/25/2023	04/25/2023	5,096.77
13509 - VORIS MECHANICAL INC.	MAIN VENTILATION FAN UPGRADE BID 22-07	04/11/2023	04/25/2023	04/25/2023	20,510.10

Account 65515 - OTHER IMPROVEMENTS Totals Invoice Transactions 2

\$25,606.87

Business Unit 4862 - LIBRARY CAPITAL IMPROVEMENT Totals Invoice Transactions 2

\$25,606.87

Department 48 - LIBRARY Totals Invoice Transactions 2

\$25,606.87

Fund 187 - LIBRARY CAPITAL IMPROVEMENT FD Totals Invoice Transactions 2

\$25,606.87

Invoice Transactions 144

\$152,757.71

* = Prior Fiscal Year Activity

Library Bills List

G/L Date Range 05/09/23 - 05/09/23

Vendor	Invoice Description	Invoice Date	G/L Date	Payment Date	Invoice Amount
Fund 185 - LIBRARY FUND					
Department 48 - LIBRARY					
Business Unit 4805 - EARLY LEARNING & LITERACY					
Account 65630 - LIBRARY BOOKS					
100474 - BAKER & TAYLOR	YA AND JUV PRINT	04/18/2023	05/09/2023	05/09/2023	81.72
100474 - BAKER & TAYLOR	JUV AND YA PRINT	04/18/2023	05/09/2023	05/09/2023	107.44
100474 - BAKER & TAYLOR	CROWN AND JUV PRINT	04/18/2023	05/09/2023	05/09/2023	654.77
100474 - BAKER & TAYLOR	CROWN AND JUV PRINT	04/19/2023	05/09/2023	05/09/2023	211.60
100474 - BAKER & TAYLOR	JUV CROWN PRINT	04/20/2023	05/09/2023	05/09/2023	241.09
100474 - BAKER & TAYLOR	CROWN AND JUV PRINT	04/22/2023	05/09/2023	05/09/2023	30.44
100474 - BAKER & TAYLOR	CROWN AND JUV PRINT	04/24/2023	05/09/2023	05/09/2023	1,328.99
100474 - BAKER & TAYLOR	CROWN AND JUV PRINT	04/25/2023	05/09/2023	05/09/2023	1,351.50
100474 - BAKER & TAYLOR	CROWN AND JUV PRINT	04/27/2023	05/09/2023	05/09/2023	1,139.64
100474 - BAKER & TAYLOR	CROWN AND JUV PRINT	04/27/2023	05/09/2023	05/09/2023	1,356.00
100474 - BAKER & TAYLOR	CROWN AND JUV PRINT	04/27/2023	05/09/2023	05/09/2023	1,077.82
Account 65630 - LIBRARY BOOKS Totals Invoice Transactions 11					\$7,581.01
Account 65641 - AUDIO VISUAL COLLECTIONS					
103424 - MIDWEST TAPE LLC	JUV AV	04/20/2023	05/09/2023	05/09/2023	30.86
19521 - PLAYAWAY PRODUCTS LLC	JUV AV	04/13/2023	05/09/2023	05/09/2023	411.93
19521 - PLAYAWAY PRODUCTS LLC	JUV AV	04/18/2023	05/09/2023	05/09/2023	104.98
19521 - PLAYAWAY PRODUCTS LLC	JUV PRINT	04/17/2023	05/09/2023	05/09/2023	116.71
19521 - PLAYAWAY PRODUCTS LLC	MAIN JUV AV	04/26/2023	05/09/2023	05/09/2023	119.98
Account 65641 - AUDIO VISUAL COLLECTIONS Totals Invoice Transactions 5					\$784.46
Business Unit 4805 - EARLY LEARNING & LITERACY Totals Invoice Transactions 16					\$8,365.47
Business Unit 4806 - LIFELONG LEARNING & LITERACY					
Account 62341 - INTERNET SOLUTION PROVIDERS					
16334 - KANOPY	MAIN ONLINE RESOURCES	04/30/2023	05/09/2023	05/09/2023	1,355.00
103424 - MIDWEST TAPE LLC	MAIN ADULT ONLINE RESOURCES	04/30/2023	05/09/2023	05/09/2023	4,499.65
Account 62341 - INTERNET SOLUTION PROVIDERS Totals Invoice Transactions 2					\$5,854.65
Account 65100 - LIBRARY SUPPLIES					
19672 - TBF DIAGNOSTIC	DIRECT FLYER MAILING REIMBURSEMENT	04/17/2023	05/09/2023	05/09/2023	54.81
Account 65100 - LIBRARY SUPPLIES Totals Invoice Transactions 1					\$54.81
Account 65630 - LIBRARY BOOKS					
100474 - BAKER & TAYLOR	ADULT PRINT	04/18/2023	05/09/2023	05/09/2023	98.84
100474 - BAKER & TAYLOR	ADULT AND CROWN PRINT	04/19/2023	05/09/2023	05/09/2023	496.22
100474 - BAKER & TAYLOR	ADULT PRINT	04/18/2023	05/09/2023	05/09/2023	701.81
100474 - BAKER & TAYLOR	CROWN AND ADULT PRINT	04/19/2023	05/09/2023	05/09/2023	458.06
100474 - BAKER & TAYLOR	ADULT PRINT	04/22/2023	05/09/2023	05/09/2023	106.50
100474 - BAKER & TAYLOR	ADULT AND CROWN PRINT	04/25/2023	05/09/2023	05/09/2023	598.20
100474 - BAKER & TAYLOR	ADULT PRINT	04/25/2023	05/09/2023	05/09/2023	276.68
100474 - BAKER & TAYLOR	ADULT AND CROWN PRINT	04/27/2023	05/09/2023	05/09/2023	69.34
100474 - BAKER & TAYLOR	CROWN AND JUV PRINT	04/26/2023	05/09/2023	05/09/2023	1,672.37
100474 - BAKER & TAYLOR	CROWN AND ADULT PRINT	04/26/2023	05/09/2023	05/09/2023	690.82
100474 - BAKER & TAYLOR	ADULT AND CROWN PRINT	04/26/2023	05/09/2023	05/09/2023	1,410.82
100474 - BAKER & TAYLOR	CROWN AND ADULT PRINT	04/27/2023	05/09/2023	05/09/2023	1,234.93
100474 - BAKER & TAYLOR	CROWN AND ADULT PRINT	04/28/2023	05/09/2023	05/09/2023	113.78

120319 - CENGAGE LEARNING INC./GALE RESEARCH	ADULT PRINT	04/18/2023	05/09/2023	05/09/2023	78.72
120319 - CENGAGE LEARNING INC./GALE RESEARCH	ADULT PRINT	04/18/2023	05/09/2023	05/09/2023	100.46
276974 - OVER DRIVE, INC.	MAUN ADULT EBOOKS	04/20/2023	05/09/2023	05/09/2023	186.58
276974 - OVER DRIVE, INC.	MAIN ADULT EBOOKS	04/26/2023	05/09/2023	05/09/2023	416.45
276974 - OVER DRIVE, INC.	MAIN ADULT EBOOKS	04/30/2023	05/09/2023	05/09/2023	359.46
276974 - OVER DRIVE, INC.	MAIN ADULT EBOOKS	04/28/2023	05/09/2023	05/09/2023	183.00
276974 - OVER DRIVE, INC.	MAIN ADULT EBOOKS	04/28/2023	05/09/2023	05/09/2023	1,150.96
276974 - OVER DRIVE, INC.	MAIN ADULT EBOOKS	04/28/2023	05/09/2023	05/09/2023	13.02
276974 - OVER DRIVE, INC.	MAIN ADULT EBOOKS	04/30/2023	05/09/2023	05/09/2023	811.49
276974 - OVER DRIVE, INC.	MAIN ADULT EBOOKS	04/20/2023	05/09/2023	05/09/2023	1,866.65
276974 - OVER DRIVE, INC.	MAIN ADULT EBOOKS	04/18/2023	05/09/2023	05/09/2023	253.29
276974 - OVER DRIVE, INC.	MAIN ADULT EBOOKS	04/20/2023	05/09/2023	05/09/2023	21.32
276974 - OVER DRIVE, INC.	MAIN ADULT EBOOKS	04/20/2023	05/09/2023	05/09/2023	197.75

Account **65630 - LIBRARY BOOKS** Totals Invoice Transactions 26

 \$13,567.52

Account **65641 - AUDIO VISUAL COLLECTIONS**

100474 - BAKER & TAYLOR	ADULT AV	04/19/2023	05/09/2023	05/09/2023	32.22
100474 - BAKER & TAYLOR	ADULT AV	04/19/2023	05/09/2023	05/09/2023	63.33
103424 - MIDWEST TAPE LLC	ADULT AV	04/26/2023	05/09/2023	05/09/2023	45.86
103424 - MIDWEST TAPE LLC	ADULT AV	04/26/2023	05/09/2023	05/09/2023	286.72
103424 - MIDWEST TAPE LLC	CROWN AND ADULT PRINT	04/26/2023	05/09/2023	05/09/2023	4.19
103424 - MIDWEST TAPE LLC	ADULT AV	04/26/2023	05/09/2023	05/09/2023	24.43
103424 - MIDWEST TAPE LLC	ADULT AV	04/26/2023	05/09/2023	05/09/2023	82.29
103424 - MIDWEST TAPE LLC	ADULT AV	04/26/2023	05/09/2023	05/09/2023	26.68
103424 - MIDWEST TAPE LLC	ADULT AV	04/20/2023	05/09/2023	05/09/2023	145.17
103424 - MIDWEST TAPE LLC	ADULT AV	04/20/2023	05/09/2023	05/09/2023	234.65
103424 - MIDWEST TAPE LLC	ADULT AV	04/20/2023	05/09/2023	05/09/2023	27.47
103424 - MIDWEST TAPE LLC	ADULT AV	04/20/2023	05/09/2023	05/09/2023	53.36

Account **65641 - AUDIO VISUAL COLLECTIONS** Totals Invoice Transactions 12

 \$1,026.37

Business Unit **4806 - LIFELONG LEARNING & LITERACY** Totals Invoice Transactions 41

 \$20,503.35

Business Unit **4820 - ACCESS SERVICES**

Account **62340 - IT COMPUTER SOFTWARE**

137361 - COOPERATIVE COMPUTER SERVICES	UNIQUE NCOA SEARCHES SERVICE FEE	04/24/2023	05/09/2023	05/09/2023	303.81
110018 - T-MOBILE USA	MOBILE HOTSPOTS 2/21/2023-4/20/2023	05/21/2023	05/09/2023	05/09/2023	8,839.19

Account **62340 - IT COMPUTER SOFTWARE** Totals Invoice Transactions 2

 \$9,143.00

Business Unit **4820 - ACCESS SERVICES** Totals Invoice Transactions 2

 \$9,143.00

Business Unit **4825 - ENGAGEMENT SERVICES**

Account **65100 - LIBRARY SUPPLIES**

100474 - BAKER & TAYLOR	ENGAGEMENT SUMMER BOOKS	04/19/2023	05/09/2023	05/09/2023	180.95
100474 - BAKER & TAYLOR	ENGAGEMENT SUMMER BOOKS	04/19/2023	05/09/2023	05/09/2023	3,221.19
100474 - BAKER & TAYLOR	ENGAGEMENT SUMMER BOOKS	04/19/2023	05/09/2023	05/09/2023	721.75
100474 - BAKER & TAYLOR	ENGAGEMENT SUMMER BOOKS	04/20/2023	05/09/2023	05/09/2023	163.56
14991 - D.I.M.E.	PROFESSIONAL SERVICE JUNE 10 CELEBRATION	04/10/2023	05/09/2023	05/09/2023	364.25
206940 - ULINE	PROGRAM SUPPLIES	04/19/2023	05/09/2023	05/09/2023	294.95

Account **65100 - LIBRARY SUPPLIES** Totals Invoice Transactions 6

 \$4,946.65

Account **65630 - LIBRARY BOOKS**

100474 - BAKER & TAYLOR	YA AND JUV PRINT	04/18/2023	05/09/2023	05/09/2023	29.34
-------------------------	------------------	------------	------------	------------	-------

100474 - BAKER & TAYLOR	ADULT AND CROWN PRINT	04/19/2023	05/09/2023	05/09/2023	84.13
100474 - BAKER & TAYLOR	CROWN AND JUV PRINT	04/18/2023	05/09/2023	05/09/2023	44.07
100474 - BAKER & TAYLOR	ADULT PRINT	04/18/2023	05/09/2023	05/09/2023	16.94
100474 - BAKER & TAYLOR	CROWN AND ADULT PRINT	04/19/2023	05/09/2023	05/09/2023	18.36
100474 - BAKER & TAYLOR	CROWN AND JUV PRINT	04/19/2023	05/09/2023	05/09/2023	66.07
100474 - BAKER & TAYLOR	JUV CROWN PRINT	04/20/2023	05/09/2023	05/09/2023	617.42
100474 - BAKER & TAYLOR	CROWN AND JUV PRINT	04/22/2023	05/09/2023	05/09/2023	70.50
100474 - BAKER & TAYLOR	CROWN AND JUV PRINT	04/24/2023	05/09/2023	05/09/2023	33.31
100474 - BAKER & TAYLOR	ADULT AND CROWN PRINT	04/25/2023	05/09/2023	05/09/2023	66.11
100474 - BAKER & TAYLOR	CROWN AND JUV PRINT	04/25/2023	05/09/2023	05/09/2023	44.98
100474 - BAKER & TAYLOR	ADULT AND CROWN PRINT	04/27/2023	05/09/2023	05/09/2023	33.81
100474 - BAKER & TAYLOR	CROWN AND JUV PRINT	04/26/2023	05/09/2023	05/09/2023	73.79
100474 - BAKER & TAYLOR	CROWN AND ADULT PRINT	04/26/2023	05/09/2023	05/09/2023	31.08
100474 - BAKER & TAYLOR	CROWN AND JUV PRINT	04/27/2023	05/09/2023	05/09/2023	25.09
100474 - BAKER & TAYLOR	ADULT AND CROWN PRINT	04/26/2023	05/09/2023	05/09/2023	98.30
100474 - BAKER & TAYLOR	CROWN AND JUV PRINT	04/27/2023	05/09/2023	05/09/2023	16.94
100474 - BAKER & TAYLOR	CROWN AND ADULT PRINT	04/27/2023	05/09/2023	05/09/2023	109.05
100474 - BAKER & TAYLOR	CROWN AND ADULT PRINT	04/28/2023	05/09/2023	05/09/2023	16.95
100474 - BAKER & TAYLOR	CROWN AND JUV PRINT	04/27/2023	05/09/2023	05/09/2023	199.39

Account **65630 - LIBRARY BOOKS** Totals Invoice Transactions 20

 \$1,695.63

Account **65641 - AUDIO VISUAL COLLECTIONS**
103424 - MIDWEST TAPE LLC

CROWN AND ADULT PRINT	04/26/2023	05/09/2023	05/09/2023	22.49
-----------------------	------------	------------	------------	-------

Account **65641 - AUDIO VISUAL COLLECTIONS** Totals Invoice Transactions 1

 \$22.49

Business Unit **4825 - ENGAGEMENT SERVICES** Totals Invoice Transactions 27

 \$6,664.77

Business Unit **4835 - INNOVATION & DIGITAL LEARNING**

Account **62340 - IT COMPUTER SOFTWARE**
18932 - PATRON POINT, INC.

ANNUAL SUBSCRIPTION RENEWAL	04/27/2023	05/09/2023	05/09/2023	9,000.00
-----------------------------	------------	------------	------------	----------

Account **62340 - IT COMPUTER SOFTWARE** Totals Invoice Transactions 1

 \$9,000.00

Account **65002 - STATE GRANT EXPENSE**

19663 - BRIAN SCOTT

PROFESSIONAL SERVICES - MUSICIAN FEE	05/08/2023	05/09/2023	05/09/2023	150.00
--------------------------------------	------------	------------	------------	--------

19578 - KIWICO INC.

STEM KITS EST1838	04/14/2023	05/09/2023	05/09/2023	3,626.15
-------------------	------------	------------	------------	----------

Account **65002 - STATE GRANT EXPENSE** Totals Invoice Transactions 2

 \$3,776.15

Account **65630 - LIBRARY BOOKS**

100474 - BAKER & TAYLOR

YA AND JUV PRINT	04/18/2023	05/09/2023	05/09/2023	164.60
------------------	------------	------------	------------	--------

100474 - BAKER & TAYLOR

JUV AND YA PRINT	04/18/2023	05/09/2023	05/09/2023	238.29
------------------	------------	------------	------------	--------

100474 - BAKER & TAYLOR

CROWN AND JUV PRINT	04/19/2023	05/09/2023	05/09/2023	603.36
---------------------	------------	------------	------------	--------

100474 - BAKER & TAYLOR

CROWN AND JUV PRINT	04/22/2023	05/09/2023	05/09/2023	67.57
---------------------	------------	------------	------------	-------

Account **65630 - LIBRARY BOOKS** Totals Invoice Transactions 4

 \$1,073.82

Business Unit **4835 - INNOVATION & DIGITAL LEARNING** Totals Invoice Transactions 7

 \$13,849.97

Business Unit **4840 - LIBRARY MAINTENANCE**

Account **62225 - BLDG MAINTENANCE SERVICES**

100891 - CARRIER CORPORATION

CHILLER SERVICE	04/17/2023	05/09/2023	05/09/2023	685.85
-----------------	------------	------------	------------	--------

151986 - CINTAS CORPORATION #769

CARPET CLEANING	04/27/2023	05/09/2023	05/09/2023	510.13
-----------------	------------	------------	------------	--------

298493 - CONQUEST PEST SOLUTIONS

PEST CONTROL	05/02/2023	05/09/2023	05/09/2023	210.00
--------------	------------	------------	------------	--------

Account **62225 - BLDG MAINTENANCE SERVICES** Totals Invoice Transactions 3

 \$1,405.98

Account **64005 - ELECTRICITY**

10730 - MC SQUARED ENERGY	MC SQUARED 03.13.2023	04/17/2023	05/09/2023	05/09/2023	7,812.69
		Account 64005 - ELECTRICITY Totals	Invoice Transactions 1		<u>\$7,812.69</u>
Account 65040 - JANITORIAL SUPPLIES					
10546 - SUPERIOR INDUSTRIAL SUPPLY	JANITORIAL SUPPLIES	05/03/2022	05/09/2023	05/09/2023	170.98
		Account 65040 - JANITORIAL SUPPLIES Totals	Invoice Transactions 1		<u>\$170.98</u>
		Business Unit 4840 - LIBRARY MAINTENANCE Totals	Invoice Transactions 5		<u>\$9,389.65</u>
Business Unit 4845 - LIBRARY ADMINISTRATION					
Account 62185 - CONSULTING SERVICES					
18957 - CHERIE ASANTE	EPL VOLUNTEER MANAGEMENT	05/05/2023	05/09/2023	05/09/2023	1,785.33
		Account 62185 - CONSULTING SERVICES Totals	Invoice Transactions 1		<u>\$1,785.33</u>
Account 62210 - PRINTING					
14051 - GRACE PRINTING & MAILING	EPL 2022 ANNUAL REPORT PRINTING AND MAILING	04/28/2023	05/09/2023	05/09/2023	20,399.00
14051 - GRACE PRINTING & MAILING	SPANISH PRINTING ANNUAL REPORT	04/28/2023	05/09/2023	05/09/2023	258.00
		Account 62210 - PRINTING Totals	Invoice Transactions 2		<u>\$20,657.00</u>
		Business Unit 4845 - LIBRARY ADMINISTRATION Totals	Invoice Transactions 3		<u>\$22,442.33</u>
		Department 48 - LIBRARY Totals	Invoice Transactions 101		<u>\$90,358.54</u>
		Fund 185 - LIBRARY FUND Totals	Invoice Transactions 101		<u>\$90,358.54</u>
			Invoice Transactions 101		<u>\$90,358.54</u>

* = Prior Fiscal Year Activity



EVANSTON PUBLIC LIBRARY
Racial Equity Task Force Meeting Minutes
May 9, 2023

Members present: Joyce Miller-Bean, Max Weinberg, Terry Soto, Michelle Judon, Yesenia Cancel, Esther Wallen, Michelle Khuu, Brenda Wallace, Melissa Molitor, Lorena Neal (notetaker), Jenette Sturges (guest staff member)

Joyce opened by reading the Land Acknowledgement.

Joyce gave an update of research and state legislation re. book bans.

Brenda gave an update on continued conversations with Carmen regarding assistance RETF members can give to suggest programs/speakers for and promote programs to the African American community and in collecting data at programs.

Melissa continued conversation and questions about the process for adding a dedicated engagement position for the AAPI community. Esther suggested that Melissa draft a formal recommendation for the Board about this. Michelle K. offered to help Melissa in developing the recommendation.

EPL's Marketing and Communications Manager, Jenette Sturges, provided a detailed overview of her work and priorities. Asked for suggestions from the group on how to reach communities better. Discussion ensued. Some suggestions include opt-in newsletters for specific communities and community ambassadors/influencers, including members of RETF.

**Library Director's Report
May 17, 2023**

Updates:

Bea Echevarria (Engagement), Cherie Asante (Volunteer Services) and Martha Meyer (Early Learning) represented EPL at the ETHS Eco Fair on Tuesday, April 25. They highlighted EPL resources related to sustainability and the environment, including the Repair Cafe, the Blueberry Awards, and more. They also informed ETHS students about volunteer opportunities at the Library.

Irene Williams (Lifelong Learning) and Carmen Francellno (Engagement) hosted a health fair on Saturday, April 29 entitled "Bridging the Gap: Disparities in Healthcare" The Health Fair received a positive response from staff and patrons. 38 people registered, but some of those did not show up. There were a number of walk-ins who had not registered, and altogether there were 50 people visiting the vendors in the Community Meeting Room. Each speaker presentation drew about 15 people. Irene is already evaluating what worked best and what can be improved for our next health fair event.

On Saturday, April 29 multiple members of the EPL Innovation & Digital Learning and Early Learning teams attended Stem Fest at Family Focus. This is a 5th ward event for K through 6th grade students of color who are underrepresented in the STEM fields. Families participated in exciting programs and workshops led predominantly (over 90%) by adults of color related to STEM. EPL staff member Elacsha Madison is one of the main organizing partners in this event, which saw over 80 BIPOC youth and their families.

Also on Saturday, April 29 was the TunePad Showcase at the ETHS Fieldhouse. EPL staff member Ozivell Ecford is the primary partner with Northwestern in bringing TunePad to all D65 5th grade classes. The showcase highlighted the music the students had coded during class session and later the music they coded was played by a live band (which included Ozivell on the drums and previous EPL Maintenance staff person Todd Galvin on guitar).

Currently on the 2nd floor of the Main Library is a special exhibit from local community environmental artists. Buckthorn is "invading" our library spaces to draw attention to the fact that this plant is all over our outdoor spaces—including backyards--and is crowding out the plants that are beneficial to our wildlife and environment. Look for it on your next visit!

Data Dashboard

<https://datastudio.google.com/reporting/071b2ae1-260b-43ca-8de4-57c7cd77cb5c>

Staff reports:

Spotlight on Connecting with the African American Community

Submitted by Carmen Francellno, Family Engagement Coordinator-Black Engagement

Highlights of the last year:

- Career Prep series: *Find Your Next Step*-December 3, 8, 15, 2022
 - Workshop series focused on job trends and job search strategies
 - Partnered with Oakton College's department of Business and Professional Services who provided speakers for each session
 - Highlighted Job Search Tech kits and job resources
 - Would like to offer this again in the fall
- Black Family Game Night-February 19, 2023
 - Wrap up event for Black History month, provided dinner and culturally relevant games such as Lyrically Correct, Black Card Revoked, and cultural trivia
 - Worked in collaboration with other EPL staff Kennedy Joseph, Tracy Olasimbo and Kellye Fleming
 - Oakton College's department of B.L.A.C.K Student Success was a partner and offered swag bags as prizes for games
- Story Quest-October 19, 2022-February 14, 2023
 - 10 week book/drama club series in partnership with Mudlark Theater
 - This cohort's book was *Dragons in a Bag* by Zetta Elliott who attended one of our sessions to speak with participants and provided them with a signed copy of her most recent book in the series
 - Mudlark provides a teaching artist to facilitate theater games related to the chosen book
- Bridging the Gap: Disparities in Healthcare-Saturday, April 29, 2023
 - Worked in collaboration with EPL staff member Irene Williams, Health and Wellness Librarian and local diagnostic testing center TBF Diagnostics
 - Offerings included keynote speaker from COE health department who discussed the EPLAN, vendors offering physical therapy and alternative wellness
- Tea & Talk (started in March 2023, ongoing monthly)
 - Modeled after the Cafecitos program
 - Space to discuss issues, challenges and successes relevant to Evanston's Black community
- Schools visits-April 2023-May 2023
 - Visiting students at Dawes, Washington, Bessie Rhodes, King Arts to share library programs, offerings and fun facts
 - Working with other EPL staff Laura Antolin, Mariana Bojorquez, and Tracy Olasimbo

Upcoming events/partnerships:

- *1619: The Journey of a People, The Musical* written by Ted Williams III
 - Have been working with Fleetwood Jourdain Theatre & Evanston Township High School, to offer two abridged performances of the musical. The first performance will be May 19th at Evanston Township High School for students. The second will take place June 17th at the community Juneteenth celebration. The goal is to

secure funding to offer the full two hour performance to the community for a limited run.

- **Untitled**
 - In discussions to offer two separate programs focused on Black wealth and business in Evanston. The first program will include a history of the Black business experience in Evanston's past. This will include a presentation from Shorefront Legacy Center and a panel discussion. The second program will be a conversation with author, retired Harvard Business School professor, and part-time Evanston resident Steven S. Rogers who will speak about his book *A Letter to My White Friends and Colleagues*.

Continued Interests:

- **The Aux**
 - Started an initial conversation with The Aux about having a library presence in the space. Those conversations have halted as they continue to work on securing funding. There was interest from both sides. This is still a hopeful partnership.
- **Oakton College department of B.L.A.C.K. Student Success**
 - Started an initial conversation about offering an open mic night event. The person previously in the role took a new position. I have remained in contact with the Manager who hopes to have a new person in the role soon.

Patron Feedback of Note:

Email from a patron received 5/1/23:

"Good afternoon, Ms. Norborg.

I am writing to let you know of my extremely positive experience this afternoon at the Evanston Public Library (Main Branch). Stephen in the Children's Library was extremely helpful as I inquired about children's books written from the perspective of a dog. Along with his colleague, Stephen curated a list of several books for me, and helped locate them for me to borrow.

The entire visit was completed in less than 20 minutes, and was such a positive experience for me. Please pass along my appreciation and gratitude for the wonderful work Stephen and his library colleagues do for Evanstonians.

With gratitude and appreciation,
(name withheld for privacy)"

April Press Mentions:

[Evanston Public Library celebrates 150 years](#). Evanston Roundtable. April 15, 2023

[Authors of new Evanston history book speak at EPL](#). Daily Northwestern. April 17, 2023

[EPL health fair to focus on disparities in care](#). Evanston Roundtable. April 19, 2023

Agenda Item 6

[Library board debates action plan to address security issues](#). Evanston Roundtable. April 20, 2023

[Library presentation to shed light on city's health disparities](#). Evanston Roundtable, April 27, 2023

[Native land acknowledgements: What are they? Why write them?](#) Evanston Roundtable, April 30, 2023



Memorandum

To: Evanston Public Library Board of Trustees
From: Heather Norborg, Interim Executive Library Director
Subject: Administrative Services Update
Date: May 11, 2023

This memo provides an update on significant administrative activities.

Human Resources

Below is a recap of our recruiting activities:

- Safety Manager position is posted on May 9 for 3 weeks
- Interviews are being scheduled and conducted for the following open positions:
 - ❖ Innovation and Digital Learning Manager, full-time in IDL
 - ❖ Development Associate, part-time in Administration
 - ❖ Social Worker, full-time in Administration
 - ❖ Finance Manager, full-time in Administration
 - ❖ Library Assistant, part-time in Early Learning and Literacy

Financial Resources

The Library Fund financial report for the period ending April 30th is included for your review. For the operating fund, revenue collection is at 47% of budget projection and expenditures 29%. Capital fund expenditures total 30% of the budget.

Facilities Update

Maintenance department is busy with Spring cleaning, landscaping, painting, taking care of the RCCC branch, and hosting an individual completing Community service hours. Capital improvement projects continue throughout the facility.



Budget Performance Report

Fiscal Year to Date 04/30/23

Include Rollup Account and Rollup to Object Account

Account	Account Description	Adopted Budget	Budget Amendments	Amended Budget	Current Month Transactions	YTD Encumbrances	YTD Transactions	Budget - YTD Transactions	% Used/ Rec'd	Prior Year Total
Fund 185 - LIBRARY FUND										
REVENUE										
Department 48 - LIBRARY										
51015	PROPERTY TAXES	7,535,472.00	.00	7,535,472.00	1,905,296.60	.00	3,837,580.91	3,697,891.09	51	7,418,797.15
52610	LIBRARY FINES & FEES	.00	.00	.00	.00	.00	.00	.00	+++	6,126.35
53200	BEV SNACK VENDING MACHINE	400.00	.00	400.00	45.41	.00	131.32	268.68	33	454.84
55201	Federal Grants	100,000.00	.00	100,000.00	.00	.00	13,549.89	86,450.11	14	125,772.01
55245	LIBRARY STATE PER CAPITA GRANT	109,866.00	.00	109,866.00	.00	.00	13,549.89	96,316.11	12	115,212.25
56011	DONATIONS	400,000.00	.00	400,000.00	.00	.00	51,989.24	348,010.76	13	359,774.48
56045	MISCELLANEOUS REVENUE	5,000.00	.00	5,000.00	.00	.00	564.27	4,435.73	11	6,194.53
56140	FEES AND MERCHANDISE SALE	.00	.00	.00	.00	.00	(43.00)	43.00	+++	(178.65)
56501	INVESTMENT INCOME	21,600.00	.00	21,600.00	18,172.54	.00	60,117.08	(38,517.08)	278	68,818.53
57002	TRANSFER FROM ENDOWMENT	250,000.00	.00	250,000.00	.00	.00	.00	250,000.00	0	217,929.86
57515	LIBRARY MATERIAL REPLACEMENT CHARGES	22,000.00	.00	22,000.00	.00	.00	7,020.78	14,979.22	32	25,133.90
57526	LIBRARY BOOK SALE	3,000.00	.00	3,000.00	.00	.00	658.57	2,341.43	22	3,604.07
57535	LIBRARY COPY MACH. CHG	9,000.00	.00	9,000.00	.00	.00	3,417.44	5,582.56	38	12,542.72
57540	LIBRARY MEETING RM RENTAL	1,000.00	.00	1,000.00	.00	.00	1,981.00	(981.00)	198	2,765.84
57545	NORTH BRANCH RENTAL INCOME	20,394.00	.00	20,394.00	.00	.00	5,098.50	15,295.50	25	20,067.00
57551	LIBRARY GRANTS	100,000.00	.00	100,000.00	(100.00)	.00	3,986.37	96,013.63	4	41,727.49
Department 48 - LIBRARY Totals		\$8,577,732.00	\$0.00	\$8,577,732.00	\$1,923,414.55	\$0.00	\$3,999,602.26	\$4,578,129.74	47%	\$8,424,742.37
REVENUE TOTALS		\$8,577,732.00	\$0.00	\$8,577,732.00	\$1,923,414.55	\$0.00	\$3,999,602.26	\$4,578,129.74	47%	\$8,424,742.37
EXPENSE										
Department 48 - LIBRARY										
61001	ESTIMATED WAGES/BENEFITS	277,466.00	.00	277,466.00	.00	.00	.00	277,466.00	0	.00
61010	REGULAR PAY	3,562,096.20	.00	3,562,096.20	217,525.56	.00	1,020,577.54	2,541,518.66	29	2,978,002.55
61050	PERMANENT PART-TIME	1,345,141.20	.00	1,345,141.20	100,670.31	.00	442,648.25	902,492.95	33	1,204,517.09
61060	SEASONAL EMPLOYEES	48,575.00	.00	48,575.00	640.00	.00	9,061.00	39,514.00	19	63,436.00
61110	OVERTIME PAY	10,000.00	.00	10,000.00	333.18	.00	7,318.27	2,681.73	73	13,584.69
61415	TERMINATION PAYOUTS	.00	.00	.00	.00	.00	13,437.01	(13,437.01)	+++	125,537.04
61420	ANNUAL SICK LEAVE PAYOUT	.00	.00	.00	.00	.00	3,373.80	(3,373.80)	+++	3,732.64
61430	VACATION PAYOUTS (PREVIOUSLY OTHER PAYOUTS)	.00	.00	.00	.00	.00	.00	.00	+++	2,100.49
61510	HEALTH INSURANCE	659,089.88	.00	659,089.88	47,110.96	.00	191,114.72	467,975.16	29	534,587.98
61513	VISION INSURANCE	657.00	.00	657.00	37.75	.00	169.60	487.40	26	620.58
61615	LIFE INSURANCE	1,927.00	.00	1,927.00	90.29	.00	370.89	1,556.11	19	2,046.40
61625	AUTO ALLOWANCE	4,800.00	.00	4,800.00	.00	.00	.00	4,800.00	0	2,400.00
61626	CELL PHONE ALLOWANCE	2,025.00	.00	2,025.00	159.00	.00	603.00	1,422.00	30	1,794.00
61630	SHOE ALLOWANCE	540.00	.00	540.00	.00	.00	.00	540.00	0	360.00
61710	IMRF	156,590.44	.00	156,590.44	10,194.69	.00	47,634.08	108,956.36	30	195,688.52
61725	SOCIAL SECURITY	301,791.59	.00	301,791.59	19,081.06	.00	89,871.15	211,920.44	30	261,772.53
61730	MEDICARE	71,420.02	.00	71,420.02	4,462.55	.00	21,018.25	50,401.77	29	61,728.26
62185	CONSULTING SERVICES	135,000.00	.00	135,000.00	4,025.83	(3,400.00)	14,146.58	124,253.42	8	170,560.50



Budget Performance Report

Fiscal Year to Date 04/30/23

Include Rollup Account and Rollup to Object Account

Account	Account Description	Adopted Budget	Budget Amendments	Amended Budget	Current Month Transactions	YTD Encumbrances	YTD Transactions	Budget - YTD Transactions	% Used/ Rec'd	Prior Year Total
Fund 185 - LIBRARY FUND										
EXPENSE										
Department 48 - LIBRARY										
62205	ADVERTISING	4,000.00	.00	4,000.00	.00	.00	19.17	3,980.83	0	1,455.61
62210	PRINTING	45,000.00	.00	45,000.00	2,345.00	20,399.00	2,475.00	22,126.00	51	9,672.27
62225	BLDG MAINTENANCE SERVICES	232,295.00	.00	232,295.00	68,062.00	105,200.00	117,858.59	9,236.41	96	241,472.84
62235	OFFICE EQUIPMENT MAINT	1,000.00	.00	1,000.00	.00	.00	.00	1,000.00	0	.00
62245	OTHER EQMT MAINTENANCE	2,277.00	.00	2,277.00	.00	.00	.00	2,277.00	0	.00
62272	OTHER PROFESSIONAL SERVICES	85,000.00	.00	85,000.00	.00	.00	.00	85,000.00	0	(2,849.23)
62275	POSTAGE CHARGEBACKS	2,600.00	.00	2,600.00	.00	.00	.00	2,600.00	0	.00
62290	TUITION	15,000.00	.00	15,000.00	.00	.00	.00	15,000.00	0	7,817.00
62295	TRAINING & TRAVEL	25,000.00	.00	25,000.00	1,487.21	.00	6,656.67	18,343.33	27	30,253.43
62305	RENTAL OF AUTO-FLEET MAINTENANCE	5,440.00	.00	5,440.00	453.00	.00	1,812.00	3,628.00	33	5,439.96
62309	RENTAL OF AUTO REPLACEMENT	4,885.00	.00	4,885.00	407.00	.00	1,628.00	3,257.00	33	4,884.96
62315	POSTAGE	1,000.00	.00	1,000.00	290.00	.00	1,062.04	(62.04)	106	4,760.28
62340	IT COMPUTER SOFTWARE	271,249.00	.00	271,249.00	3,144.28	.00	38,591.85	232,657.15	14	219,674.70
62341	INTERNET SOLUTION PROVIDERS	280,255.00	.00	280,255.00	32,689.38	.00	113,319.41	166,935.59	40	359,646.91
62360	MEMBERSHIP DUES	2,075.00	.00	2,075.00	500.00	.00	1,409.00	666.00	68	2,006.00
62380	COPY MACHINE CHARGES	10,000.00	.00	10,000.00	.00	.00	.00	10,000.00	0	.00
62506	WORK- STUDY	8,500.00	.00	8,500.00	1,061.86	.00	1,061.86	7,438.14	12	4,633.52
62705	BANK SERVICE CHARGES	5,700.00	.00	5,700.00	370.82	.00	1,813.24	3,886.76	32	4,479.26
64005	ELECTRICITY	120,000.00	.00	120,000.00	.00	.00	13,891.69	106,108.31	12	89,498.92
64009	UTILITIES - COE WATER	11,000.00	.00	11,000.00	.00	.00	3,164.39	7,835.61	29	7,454.59
64015	NATURAL GAS	33,900.00	.00	33,900.00	1,178.50	.00	5,640.37	28,259.63	17	24,628.05
64540	TELECOMMUNICATIONS - WIRELESS	.00	.00	.00	.00	.00	.00	.00	+++	4,739.83
65001	FEDERAL GRANT EXPENSE	21,590.00	.00	21,590.00	.00	.00	189.54	21,400.46	1	.00
65002	STATE GRANT EXPENSE	13,300.00	.00	13,300.00	2,250.00	3,626.22	2,493.63	7,180.15	46	.00
65020	CLOTHING	.00	.00	.00	.00	.00	.00	.00	+++	1,827.52
65025	FOOD	7,000.00	.00	7,000.00	.00	.00	306.53	6,693.47	4	8,186.46
65040	JANITORIAL SUPPLIES	18,377.00	.00	18,377.00	1,828.48	.00	14,969.61	3,407.39	81	7,598.90
65050	BLDG MAINTENANCE MATERIAL	35,000.00	.00	35,000.00	1,050.00	.00	2,992.48	32,007.52	9	16,772.30
65095	OFFICE SUPPLIES	50,000.00	.00	50,000.00	464.65	7,586.17	2,082.79	40,331.04	19	26,820.89
65100	LIBRARY SUPPLIES	107,930.00	.00	107,930.00	9,082.36	1,567.58	25,090.98	81,271.44	25	143,036.91
65141	FITNESS INCENTIVE	.00	.00	.00	.00	.00	.00	.00	+++	1,500.00
65503	FURNITURE / FIXTURES / EQUIPMENT	1,500.00	.00	1,500.00	.00	.00	.00	1,500.00	0	1,000.00
65555	IT COMPUTER HARDWARE	36,650.00	.00	36,650.00	.00	.00	3,267.00	33,383.00	9	83,188.07
65630	LIBRARY BOOKS	561,400.00	.00	561,400.00	26,015.85	.00	137,725.29	423,674.71	25	506,777.66
65635	PERIODICALS	6,500.00	.00	6,500.00	.00	.00	3,842.91	2,657.09	59	6,015.23
65641	AUDIO VISUAL COLLECTIONS	50,500.00	.00	50,500.00	2,522.89	.00	15,344.92	35,155.08	30	49,140.20
66131	TRANSFER TO GENERAL FUND	295,000.00	.00	295,000.00	24,583.00	.00	98,332.00	196,668.00	33	289,328.04
66132	TRANSFER TO HUMAN SERVICES FUND	.00	.00	.00	.00	.00	.00	.00	+++	80,000.04



Budget Performance Report

Fiscal Year to Date 04/30/23

Include Rollup Account and Rollup to Object Account

Account	Account Description	Adopted Budget	Budget Amendments	Amended Budget	Current Month Transactions	YTD Encumbrances	YTD Transactions	Budget - YTD Transactions	% Used/ Rec'd	Prior Year Total
Fund 185 - LIBRARY FUND										
EXPENSE										
	Department 48 - LIBRARY Totals	\$8,948,042.33	\$0.00	\$8,948,042.33	\$584,117.46	\$134,978.97	\$2,478,385.10	\$6,334,678.26	29%	\$7,863,330.39
	EXPENSE TOTALS	\$8,948,042.33	\$0.00	\$8,948,042.33	\$584,117.46	\$134,978.97	\$2,478,385.10	\$6,334,678.26	29%	\$7,863,330.39
	Fund 185 - LIBRARY FUND Totals									
	REVENUE TOTALS	8,577,732.00	.00	8,577,732.00	1,923,414.55	.00	3,999,602.26	4,578,129.74	47%	8,424,742.37
	EXPENSE TOTALS	8,948,042.33	.00	8,948,042.33	584,117.46	134,978.97	2,478,385.10	6,334,678.26	29%	7,863,330.39
	Fund 185 - LIBRARY FUND Totals	(\$370,310.33)	\$0.00	(\$370,310.33)	\$1,339,297.09	(\$134,978.97)	\$1,521,217.16	(\$1,756,548.52)		\$561,411.98
Fund 186 - LIBRARY DEBT SERVICE FUND										
REVENUE										
	Department 48 - LIBRARY									
51015	PROPERTY TAXES	507,913.00	.00	507,913.00	.00	.00	.00	507,913.00	0	506,626.00
	Department 48 - LIBRARY Totals	\$507,913.00	\$0.00	\$507,913.00	\$0.00	\$0.00	\$0.00	\$507,913.00	0%	\$506,626.00
	REVENUE TOTALS	\$507,913.00	\$0.00	\$507,913.00	\$0.00	\$0.00	\$0.00	\$507,913.00	0%	\$506,626.00
EXPENSE										
	Department 48 - LIBRARY									
68305	DEBT SERVICE- PRINCIPAL	275,730.00	.00	275,730.00	.00	.00	.00	275,730.00	0	264,706.00
68315	DEBT SERVICE- INTEREST	232,183.00	.00	232,183.00	.00	.00	.00	232,183.00	0	240,281.64
	Department 48 - LIBRARY Totals	\$507,913.00	\$0.00	\$507,913.00	\$0.00	\$0.00	\$0.00	\$507,913.00	0%	\$504,987.64
	EXPENSE TOTALS	\$507,913.00	\$0.00	\$507,913.00	\$0.00	\$0.00	\$0.00	\$507,913.00	0%	\$504,987.64
	Fund 186 - LIBRARY DEBT SERVICE FUND Totals									
	REVENUE TOTALS	507,913.00	.00	507,913.00	.00	.00	.00	507,913.00	0%	506,626.00
	EXPENSE TOTALS	507,913.00	.00	507,913.00	.00	.00	.00	507,913.00	0%	504,987.64
	Fund 186 - LIBRARY DEBT SERVICE FUND Totals	\$0.00	\$0.00	\$0.00	\$0.00	\$0.00	\$0.00	\$0.00		\$1,638.36
Fund 187 - LIBRARY CAPITAL IMPROVEMENT FD										
REVENUE										
	Department 48 - LIBRARY									
56060	BOND PROCEEDS	950,000.00	.00	950,000.00	.00	.00	.00	950,000.00	0	.00
	Department 48 - LIBRARY Totals	\$950,000.00	\$0.00	\$950,000.00	\$0.00	\$0.00	\$0.00	\$950,000.00	0%	\$0.00
	REVENUE TOTALS	\$950,000.00	\$0.00	\$950,000.00	\$0.00	\$0.00	\$0.00	\$950,000.00	0%	\$0.00
EXPENSE										
	Department 48 - LIBRARY									
65515	OTHER IMPROVEMENTS	950,000.00	.00	950,000.00	25,606.87	240,438.20	253,980.41	455,581.39	52	173,737.09
	Department 48 - LIBRARY Totals	\$950,000.00	\$0.00	\$950,000.00	\$25,606.87	\$240,438.20	\$253,980.41	\$455,581.39	52%	\$173,737.09
	EXPENSE TOTALS	\$950,000.00	\$0.00	\$950,000.00	\$25,606.87	\$240,438.20	\$253,980.41	\$455,581.39	52%	\$173,737.09
	Fund 187 - LIBRARY CAPITAL IMPROVEMENT FD Totals									
	REVENUE TOTALS	950,000.00	.00	950,000.00	.00	.00	.00	950,000.00	0%	.00
	EXPENSE TOTALS	950,000.00	.00	950,000.00	25,606.87	240,438.20	253,980.41	455,581.39	52%	173,737.09



Budget Performance Report

Fiscal Year to Date 04/30/23

Include Rollup Account and Rollup to Object Account

Account	Account Description	Adopted Budget	Budget Amendments	Amended Budget	Current Month Transactions	YTD Encumbrances	YTD Transactions	Budget - YTD Transactions	% Used/ Rec'd	Prior Year Total
Fund	187 - LIBRARY CAPITAL IMPROVEMENT FD Totals	\$0.00	\$0.00	\$0.00	(\$25,606.87)	(\$240,438.20)	(\$253,980.41)	\$494,418.61		(\$173,737.09)
	Grand Totals									
	REVENUE TOTALS	10,035,645.00	.00	10,035,645.00	1,923,414.55	.00	3,999,602.26	6,036,042.74	40%	8,931,368.37
	EXPENSE TOTALS	10,405,955.33	.00	10,405,955.33	609,724.33	375,417.17	2,732,365.51	7,298,172.65	30%	8,542,055.12
	Grand Totals	(\$370,310.33)	\$0.00	(\$370,310.33)	\$1,313,690.22	(\$375,417.17)	\$1,267,236.75	(\$1,262,129.91)		\$389,313.25

**Evanston Public Library Endowment Fund
Statement of Activity
March 01, 2023 through March 31, 2023**

Beginning Balance		3,943,716.74
Revenue		
Investment results	33,533.62	
Total Revenues		33,533.62
Distributions/Grants and Expenses		
Foundation support charge	-2,136.77	
Total Distributions		-2,136.77
Ending Balance		3,975,113.59

Endowment for the Evanston Public Library
 Holdings as of April 2023

	Symbol	Shares/Quantity	Price	Value as of April 30, 2023	% of portfolio	% of portfolio by asset class
Vanguard Federal Money Market Fund	VMFXX	1.000	\$282,862.87	\$282,862.87	100.00%	100.0%
US Treasury TIPS Notes, maturing 1/25, 2.375%		100000.000	\$0.000	\$0.00	0.00%	
US Treasury TIPS Notes, maturing 1/26, 2.0%		100000.000	\$0.000	\$0.00	0.00%	
US Treasury TIPS Notes, maturing 2/40, 2.125%		100000.000	\$0.000	\$0.00	0.00%	0.0%
				\$282,862.87		100.0%
						Cash Equivalents 100.0%
						US Treasury Inflation Protected Securities 0.0%
						100.0%



Memorandum

To: Evanston Public Library Facilities Committee and Library Board
Heather Norborg

From: John Devaney - Facilities Manager

Subject: Approval of Main Library Boiler Upgrade BID 23-07 CIP 480031

Date: May 8, 2023

Recommended Action:

Staff recommends Facilities Committee/Library Board approval for the proposal from Anchor Mechanical., located at 225 N. California Ave., Chicago, IL 60630 for replacement/upgrade of two (2) house heating boilers at the Main Library indicated in **Bid 23-07/480031** for the amount of **\$546,975.00**.

Funding Source:

Funding is from the 2023 Capital Improvement Fund account 187.48.4862.65515.480032 and will be paid through Library debt. The budget for this project is \$700,000.00.

Summary:

This proposal includes the furnishing/installation programming of all equipment, parts, automation controls and commissioning/labor for the replacement two house heating boilers at the Main library. Anchor Mechanical will recycle all metals at no charge to EPL. The comprehensive facility assessment report developed by Wiss Janney Elsnor for the Main Library included recommendations for major heating upgrades to our facility as high priority. As a result of this assessment report, the replacement of the boilers is included in the 2023 Capital Improvement Budget approved by the Library Board in fall of 2022. The existing boilers are original to the facility and have reached their useful life expectancy. Boiler #2 is currently leaking.

This initiative taken and funded by EPL will have major impact to the **City's Climate Action and Resilience Plan (CARP)**. Improvements at the Main facility over the last ten years places our building firmly in line (and well ahead of) the majority of COE facilities with conserving energy including, natural gas, water, and electricity. EPL will meet or exceed the City's 3-YEAR IMPLEMENTATION PLAN for 2025 (of a 25% reduction) after the 2023 CIP program is complete. 2022/23 CIP includes replacement fans, boilers and

LED lighting. EPL is making its contribution to reduce its Municipal facility carbon footprint through building performance standards along with building code updates.

2025 CARP = Reduce building energy consumption by 25% (35% by 2035 and 50% by 2050)

During February 2023, EPL and COE Purchasing department publically advertised Bid 23-07 480031 Main Library House Heating Boiler Upgrade was issued. We received six (6) bids back for evaluation.

The following firms submitted bids by the April deadline for consideration:

Key West Industries	\$456,046.00	\$501,650.00
Anchor Mechanical	\$497,250	\$546,975.00
Voris Mechanical	\$543,100.00	\$597,410.00
Reed Construction	\$615,000.00	\$625,000.00
Core Mechanical	\$577,145	\$634,859.00
Autumn Construction	\$632,000	\$694,500.00

Anchor Mechanical submitted the most responsible and responsive bid for the project.

Staff recommends that Anchor Mechanical be awarded this project based on their pricing, positive references, and recent project scopes. Anchor has the lowest responsive/responsible bid in the amount of \$546,975. If the Facilities Committee approves this project recommendation it will be presented to the Library Board for approval on May 17, 2023.

Time is of the essence for this project due to a failed unit (B2), extended equipment lead time on boilers and associated materials along with a busy construction season spring/summer 2023.

Attachments:

1. Received Bids. (6)
2. Project technical specifications.
3. GBA bid evaluation memo

EXHIBIT A – BID FORM
For
MAIN LIBRARY HEATING BOILER UPGRADE

(BID #23-07)

1.01 BID TO:

THE CITY OF EVANSTON/EVANSTON PUBLIC LIBRARY
2100 Ridge Avenue
Evanston, Illinois 60201

Hereinafter called "OWNER".

1.02 BID FROM:

ANCHOR MECHANICAL, INC.
(Hereinafter call "BIDDER")

855 N. CALIFORNIA AVE.
Address CHICAGO, IL 60612

312-492-6994
Telephone Number

312-492-6996
Fax Number

1.03 BID FOR: **MAIN LIBRARY HEATING BOILERUPGRADE (BID 23-07)**

1.04 ACKNOWLEDGEMENT:

A. The Bidder, in compliance with the Invitation for Bids, having carefully examined the Drawings and Project Manual with related documents and having visited the site of the proposed Work, and being familiar with all of the existing conditions and limitations surrounding the construction of the proposed project, including the structure of the ground, subsurface conditions, the obstacles which may be encountered, local restrictions, and all other relevant matters concerning the Work to be performed, hereby PROPOSES to perform everything required to be performed, and to provide all labor, materials, necessary tools and equipment, expendable equipment, all applicable permits and taxes and fees, and provide all utility and transportation services necessary to perform and complete in a workmanlike manner the Project in accordance with all the plans, specifications and

related Contract Documents as prepared by the City of Evanston/Evanston Public Library.

- B. The undersigned hereby acknowledges receipt of Invitation of Bids, Instruction to Bidder, the Project Manual, Drawings, and other Contract Documents and acknowledges receipt of the following Addenda:

Addendum No.	<u>1</u>	Dated	<u>3/30/23</u>
Addendum No.	<u>2</u>	Dated	<u>4/18/23</u>
Addendum No.	_____	Dated	_____

1.05 GENERAL STATEMENTS

- A. The undersigned has checked all of the figures contained in this proposal and further understands that the Owner will not be responsible for any errors or omissions made therein by the undersigned.
- B. It is understood that the right is reserved by the Owner to reject any or all proposals, to waive all informality in connection therewith and to award a Contract for any part of the work or the Project as a whole.
- C. The undersigned declares that the person(s) signing this proposal is/are fully authorized to sign on behalf of the named firm and to fully bind the named firm to all the conditions and provisions thereof.
- D. It is agreed that no person(s) or company other than the firm listed below or as otherwise indicated hereinafter has any interest whatsoever in this proposal or the Contract that may be entered into as a result thereof, and that in all respects the proposal is legal and fair, submitted in good faith, without collusion or fraud.
- E. It is agreed that the undersigned has complied and/or will comply with all requirements concerning licensing and with all other local, state and national laws, and that no legal requirement has been or will be violated in making or accepting this proposal, in awarding the Contract to him, and/or in the prosecution of the Work required hereunder.
- F. To be considered a bona fide offer, this proposal must be completed in full and accompanied by a bid deposit or a bid bond when required by Contract Documents or Addenda.

1.06 ALTERNATES

- A. When alternate proposals are required by Contract Documents or Addenda thereto, the undersigned proposes to perform alternates for herein stated additions to or deductions from hereinbefore stated Base Bid. Additions and deductions include all modifications of Work or additional Work that the undersigned may be required to perform by reason of the acceptance of alternates.

1.07 ALLOWANCE

- A. The allowance is general and should be used in the event that any unforeseen condition is discovered. After discovering the unforeseen condition, the contractor shall submit a Found Condition Report (FCR) and an Authorization to Use Allowance (AUA) to the Consultant. The Consultant will then notify the Owner and both the Owner and the Consultant will view the unforeseen condition to determine if the work will be authorized. Under no circumstances shall the contractor move forward with the work in question nor shall the contractor expend allowance without an approved AUA. At the end of the project, unspent allowance shall be credited to owner via change order.

1.08 AGREEMENT

- A. In submitting this Bid, the undersigned agrees:
 - 1. To hold this Bid open for sixty (60) days from submittal date.
 - 2. To enter into and execute a Contract with the Owner within ten (10) days after receiving Notice of Award from the Owner.
 - 3. To accomplish the work in accordance with the Contract Documents.
 - 4. To complete the work by the time stipulated in the General Conditions
- B. The Owner reserves the right to reject any and all Bids and to waive any informalities in Bidding.

1.09 SCHEDULE

- A. See General Conditions for required schedule of completion dates.

1.10 PROPOSED PRICES

- A. The Bidder hereby proposes to furnish all labor, materials, equipment, transportation, construction plant and facilities necessary to complete, in a workmanlike manner and in accordance with the contract documents, the contract of work bid upon herein for compensation in accordance with the following prices:

BASE BID AMOUNT: \$ 497,250.00

ALLOWANCE (ADDITIONAL WORK – GENERAL): \$ 10%

TOTAL BASE BID AMOUNT: \$ 546,975.00

1.11 UNIT PRICING LIST

The undersigned submits the following UNIT PRICING LIST to be performed as shown on the Plans and/or described in the Specifications, and agrees that items of work not specifically mentioned in the Schedule which are necessary and required

to complete the work intended shall be done incidental to and as part of the work for which a unit price is given, and understands that no additional payment will be made for such incidental work from the estimated quantities shown below. Unit prices for individual line items shall be used for the project's schedule of values, pay applications and will also be used to determine the amount to ADD TO or DEDUCT FROM the contract LUMP SUM PRICE for properly authorized additional or deducted work. In the event of a change to the contract the contractor shall be limited to markup percentages as indicated in Section 01028, 1.05, A. Bidders shall examine plans and determine actual work items and quantities for the work involved for bid analysis by the Owner.

SEE ATTACHED SHEET

Item	Description	Unit	Base Bid Quantity	Add Cost *	Deduct Cost **
1	TO BE COMPLETED BY CONSULTANT	XX	XX	\$	\$

* Add costs to be provided by Bidder

** Deduct costs to be provided by Bidder

1.12 BID SECURITY

If required by the bid documents, a scanned copy of the bid bond must be included with the bid electronic submission. The City is currently not able to accept a certified check, bank cashier's check or electronic bid bond at this time.

- A. The City of Evanston Civic Center is unable to receive in person drop-off and it is closed to the public. The original bid bond must be mailed within ten (10) days after the due date, to the City of Evanston Purchasing Department, 2100 Ridge Avenue - Room 4200 Evanston, Illinois 60201 Attention Purchasing Manager using the USPS (certified or priority), UPS or FedEx mail options in order to have a tracking number.
- B. Accompanying this electronic submittal is a scanned copy of a bank draft, bid bond, Cashier's check or Certified check as surety in the amount of not less than five percent (5%) of the Total Bid payable to the City of Evanston/Evanston Public Library.

The amount of the check or draft is: \$ BID BOND 5%

If this bid is accepted and the undersigned shall fail to execute a contract and contract bond as required it is hereby agreed that the amount of the check or draft or bidder's bond substituted in lieu thereof, shall become the property of the City and shall be considered as payment of damages due to delay and other causes suffered by the City because of the failure to execute said contract and contract

bond; otherwise said check or draft shall be returned to the undersigned.

In the event that one check or draft is intended to cover two or more bids, the amount must be equal to the sum of the project proposal guarantees of the individual sections covered.

If the check or draft is placed on another project proposal, state below where it may be found, as follows: The check or draft will be found in the project proposal for:

N/A

1.13 PERFORMANCE/PAYMENT BOND

The undersigned bidder agrees to provide Performance Bond and Payment Bond executed in accordance with Contract Performance Bond form furnished by and acceptable to the Owner written with TRAVELERS CASUALTY AND SURETY COMPANY OF AMERICA in the amount of 100% of the Contract Sum (Total Base Bid and all accepted alternatives and adjustments) the cost of which is included in the Bid.

Cost of bond for change order is 0.81 percent of change order cost.

1.14 LIQUIDATED DAMAGES

The undersigned Bidder understands and agrees to the provisions stated under "LIQUIDATED DAMAGES" in the General Conditions and shall be assessed at the specified daily rate for each calendar day or partial calendar day until completion as defined herein.

1.15 MATERIAL SUBSTITUTION SHEET

The following is a schedule of substitute materials I propose to furnish on this job, with the difference in price being added to or deducted from the Base Bid. The Base Bid is understood to include only those items which are definitely specified by trade names or otherwise.

I understand that if no price difference is indicated, then the selection of materials is optional with the Owner, and approval or rejection of the substitution below will be indicated prior to signing of Contracts.

<u>PRODUCT NAME AND/OR MANUFACTURER</u>	<u>ADD</u>	<u>DEDUCT</u>
-----------------------------------------	------------	---------------

NO SUBSTITUTIONS

1.16 PROPOSAL SIGNATURE (REQUIRED)

A. SOLE PROPRIETOR

Signature of Bidder: _____

SUBSCRIBED AND SWORN to before me this _____ day of _____, 20__

Notary Public

Commission Expires: _____

B. PARTNERSHIP

Signature of All Partners: _____

Name (typed or printed)

Name (typed or printed)

SUBSCRIBED AND SWORN to before me this 25th day of April, 2023

Emily Cunniff Commission Expires: March 04, 2026
Notary Public

C. CORPORATION

Signature of Authorized Official: _____

Title: PRESIDENT

Name above (typed or printed): MICHAEL ROSNER

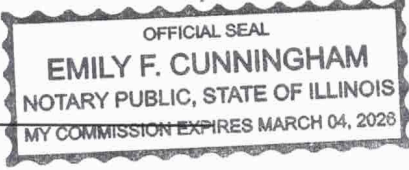

(If other than the president, attach a certified copy of that section of corporate by-laws or other authorization by the Corporation which permits the person to execute the offer for the Corporation.)

(Corporate Seal)

Attest: _____
Secretary

SUBSCRIBED AND SWORN to before me this 25th day of April, 2023

Emily Cunniff Commission Expires: March 04, 2026
Notary Public



1.17 DISCLOSURE

- A. The undersigned duly sworn deposes and says on oath that the bidder has withheld no disclosures of ownership interest and the information provided herein to the best of its knowledge is current and said undersigned has not entered into any agreement with any other bidder or prospective bidder or with any other person, firm or corporation relating to the price named in said proposal or any other proposal, nor any agreement or arrangement under which any person, firm or corporation is to refrain from bidding, nor any agreement or arrangement for any act or omission in restraint of free competition among bidders and has not disclosed to any person, firm or corporation the terms of this bid or the price named herein.

Bidder: ANCHOR MECHANICAL INC

Business Address: 855 N. CALIFORNIA AVE
CHICAGO, IL 60612

Telephone Number: 312-492-6994

1.18 CONTACTS

- A. In the event the Evanston City Council approves this bid response, list the name, address, telephone, and fax number of the person to be contacted:

Bidder: GUNTHER SCHUMANN

Address: 855 N. CALIFORNIA AVE
CHICAGO, IL 60612

Telephone Number: 847-409-8895

Fax Number: 312-492-6996

1.19 REFERENCES

A. Provide three (3) references for which your firm has completed work of a similar scope in the past.

1. Name: CHICAGO PARK DISTRICT - DEHUMID UNIT UPGRADE
Address: 1330 W. CHICAGO, IL 60609
Contact Person: GUS PASQUALE
Phone: 312 - 735 - 8031
Contract Value: \$650,000.00
Contract Dates: COMPLETED MAY 2021
2. Name: SUMMIT HILL JR HIGH - COOLING TOWER
Address: 2260 W. N. AVE FRANKFORD, IL 60423
Contact Person: GLEN WYSONO
Phone: 708-846-6506
Contract Value: \$200,000.00
Contract Dates: COMPLETED AUGUST 2022
3. Name: IL TOLLWAY PLAZA 33 MECH SYSTEM UPGRADE
Address: TRI-STATE TOLLWAY + IRVING PK. RD.
Contact Person: ZIA AHMED
Phone: 630-420-1700
Contract Value: \$820,345.11
Contract Dates: COMPLETED APRIL 2019

EXHIBIT O

BID BOND SUBMITTAL LABEL

CUT AND ATTACH LABEL ON OUTSIDE OF SEALED BID BOND SUBMITTAL

✂-----

BID SUBMITTAL NUMBER: 23-07

BID SUBMITTAL NAME: MAIN LIBRARY HEATING
BOILER UPGRADE

BID SUBMITTAL DUE DATE/TIME: 4/25/23 2:00 PM

COMPANY NAME: AUTOR MECHANICAL INC.

COMPANY ADDRESS: 255 N. CALIFORNIA AVE CHICAGO, IL 60612

COMPANY TELEPHONE #: 312-492-6994

✂-----

If required by the bid documents, a scanned copy of the bid bond must be included with the bid electronic submission. The City is currently not able to accept a certified check, bank cashier's check or electronic bid bond at this time.

The original bid bond (in the amount of 5% of the original bid amount) must be mailed within ten (10) days after the bid due date, to the City of Evanston Purchasing Department, 2100 Ridge Avenue - Room 4200 Evanston, Illinois 60201 Attention Purchasing Manager using the USPS (certified or priority), UPS or FedEx mail options in order to have a tracking number; which sum shall be forfeited in case the successful bidder fails to enter into a binding contract and provide a properly executed contract and surety bond within 15 days after the date the contract is awarded by the City.

THE AMERICAN INSTITUTE OF ARCHITECTS

AIA Document A310 Bid Bond

KNOW ALL MEN BY THESE PRESENTS, THAT WE Anchor Mechanical, Inc.

255 N. California Avenue, Chicago, IL 60612

as Principal, hereinafter called the Principal, and Travelers Casualty and Surety Company of America

One Tower Square, Hartford, CT 06183

a corporation duly organized under the laws of the State of CT

as Surety, hereinafter called the Surety, are held and firmly bound unto City of Evanston

2100 Ridge Avenue, Evanston, IL 60201

as Obligee, hereinafter called the Obligee, in the sum of Five Percent of Amount Bid

Dollars (\$ 5%),
for the payment of which sum well and truly to be made, the said Principal and the said Surety, bind ourselves, our heirs, executors, administrators, successors and assigns, jointly and severally, firmly by these presents.

WHEREAS, the Principal has submitted a bid for Main Library Heating Boiler Upgrade (BID #23-07)

NOW, THEREFORE, if the Obligee shall accept the bid of the Principal and the Principal shall enter into a Contract with the Obligee in accordance with the terms of such bid, and give such bond or bonds as may be specified in the bidding or Contract Documents with good and sufficient surety for the faithful performance of such Contract and for the prompt payment of labor and materials furnished in the prosecution thereof, or in the event of the failure of the Principal to enter such Contract and give such bond or bonds, if the Principal shall pay to the Obligee the difference not to exceed the penalty hereof between the amount specified in said bid and such larger amount for which the Obligee may in good faith contract with another party to perform the Work covered by said bid, then this obligation shall be null and void, otherwise to remain in full force and effect.

Signed and sealed this 24th day of April, 2023



Tom Inzuga
(Witness)

Anchor Mechanical, Inc.

(Principal) (Seal)

By:

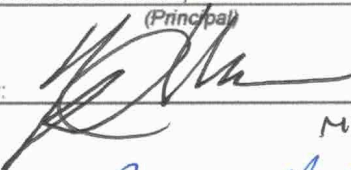
PRESIDENT
MIKE ROSNER (Title)

Travelers Casualty and Surety Company of America

(Surety) (Seal)

By:

Attorney-in-Fact Pramod Venkatesh (Title)

John P. Harney

(Witness)



POWER OF ATTORNEY

NOW ALL MEN BY THESE PRESENTS: That Travelers Casualty and Surety Company of America, Travelers Casualty and Surety Company, and St. Paul Fire and Marine Insurance Company are corporations duly organized under the laws of the State of Connecticut (herein collectively called the "Companies"), and that the Companies do hereby make, constitute and appoint Pramod Venkatesh of CHICAGO Illinois, their true and lawful Attorney(s)-in-Fact to sign, execute, seal and acknowledge any and all bonds, recognizances, conditional undertakings and other writings obligatory in the nature thereof on behalf of the Companies in their business of guaranteeing the fidelity of persons, guaranteeing the performance of contracts and executing or guaranteeing bonds and undertakings required or permitted in any actions or proceedings allowed by law.

IN WITNESS WHEREOF, the Companies have caused this instrument to be signed, and their corporate seals to be hereto affixed, this 21st day of April, 2021.



State of Connecticut

City of Hartford ss.

By: [Signature] Robert L. Raney, Senior Vice President

On this the 21st day of April, 2021, before me personally appeared Robert L. Raney, who acknowledged himself to be the Senior Vice President of each of the Companies, and that he, as such, being authorized so to do, executed the foregoing instrument for the purposes therein contained by signing on behalf of said Companies by himself as a duly authorized officer.

IN WITNESS WHEREOF, I hereunto set my hand and official seal.

My Commission expires the 30th day of June, 2026



[Signature] Anna P. Nowik, Notary Public

This Power of Attorney is granted under and by the authority of the following resolutions adopted by the Boards of Directors of each of the Companies, which resolutions are now in full force and effect, reading as follows:

RESOLVED, that the Chairman, the President, any Vice Chairman, any Executive Vice President, any Senior Vice President, any Vice President, any Second Vice President, the Treasurer, any Assistant Treasurer, the Corporate Secretary or any Assistant Secretary may appoint Attorneys-in-Fact and Agents to act for and on behalf of the Company and may give such appointee such authority as his or her certificate of authority may prescribe to sign with the Company's name and seal with the Company's seal bonds, recognizances, contracts of indemnity, and other writings obligatory in the nature of a bond, recognizance, or conditional undertaking, and any of said officers or the Board of Directors at any time may remove any such appointee and revoke the power given him or her; and it is

FURTHER RESOLVED, that the Chairman, the President, any Vice Chairman, any Executive Vice President, any Senior Vice President or any Vice President may delegate all or any part of the foregoing authority to one or more officers or employees of this Company, provided that each such delegation is in writing and a copy thereof is filed in the office of the Secretary; and it is

FURTHER RESOLVED, that any bond, recognizance, contract of indemnity, or writing obligatory in the nature of a bond, recognizance, or conditional undertaking shall be valid and binding upon the Company when (a) signed by the President, any Vice Chairman, any Executive Vice President, any Senior Vice President or any Vice President, any Second Vice President, the Treasurer, any Assistant Treasurer, the Corporate Secretary or any Assistant Secretary and duly attested and sealed with the Company's seal by a Secretary or Assistant Secretary; or (b) duly executed (under seal, if required) by one or more Attorneys-in-Fact and Agents pursuant to the power prescribed in his or her certificate or their certificates of authority or by one or more Company officers pursuant to a written delegation of authority; and it is

FURTHER RESOLVED, that the signature of each of the following officers: President, any Executive Vice President, any Senior Vice President, any Vice President, any Assistant Vice President, any Secretary, any Assistant Secretary, and the seal of the Company may be affixed by facsimile to any Power of Attorney or to any certificate relating thereto appointing Resident Vice Presidents, Resident Assistant Secretaries or Attorneys-in-Fact for purposes only of executing and attesting bonds and undertakings and other writings obligatory in the nature thereof, and any such Power of Attorney or certificate bearing such facsimile signature or facsimile seal shall be valid and binding upon the Company and any such power so executed and certified by such facsimile signature and facsimile seal shall be valid and binding on the Company in the future with respect to any bond or understanding to which it is attached.

I, Kevin E. Hughes, the undersigned, Assistant Secretary of each of the Companies, do hereby certify that the above and foregoing is a true and correct copy of the Power of Attorney executed by said Companies, which remains in full force and effect.

Dated this 24th day of April, 2023



[Signature] Kevin E. Hughes, Assistant Secretary

To verify the authenticity of this Power of Attorney, please call us at 1-800-421-3880. Please refer to the above-named Attorney(s)-in-Fact and the details of the bond to which this Power of Attorney is attached.

State of Illinois
County of Cook

On this 24th day of April 2023, before me personally appeared
Pramod Venkatesh, known to me to be the Attorney-in-fact of
Travelers Casualty and Surety Company of America, the corporation that executed the
within instrument, and acknowledged to me that such corporation executed the same.

IN WITNESS WHEREOF, I have hereunto set my hand and affixed my official seal, at my office in the
aforesaid county, the day and year in this certificate first above written.



M Labno

(Notary Public)

(Seal)



Anchor Mechanical Incorporated

Corporate Headquarters USA
255 North California Ave. Chicago, IL 60612
312-492-6994 Fax 312-492-6996
www.anchormechanical.com



City of Evanston Bid 23-07 Main Library Boiler Upgrade Anchor Mechanical Questionnaire

1. Please provide us with all costs related to the project. Subcontractors, labor, insurances, material, OH&P. **See attached cost sheet.**
2. Please provide us with a summary and timeline for the project assuming the lead time on the boilers is 12 weeks. Assuming a May 20th award. **See attached schedule and notes.**
3. Please summarize similar projects your firm has completed within the last two years.
 - Cicero School District – Boiler Replacements
 - Chicago Park District – Boiler Replacements
 - Illinois Tollway – Plaza 33 Boiler Replacements
4. Please list any foreseen/unforeseen concerns that you see which may end in a project change order or delays. Change orders are difficult.
 - **Any delays getting street closure approval.**
5. Does your plan call for an on-sight superintendent/project manager or a person of responsibility from your firm when *any* work is done onsite? All projects begin with high hopes for success but end up off track and plagued with problems with an inexperienced team. Evanston Library is a public facility that serves up to two thousand patrons a day so project performance is critical so it does not leave room for delays or errors.
 - **Anchor will have someone on site for all work.**
6. Are you able to produce a paralleled project schedule that reflects a tight schedule over the term? Can you provide a sample schedule of what you would produce for EPL?
 - **See attached schedule as well as an example from a previous project.**
7. Has your firm performed any recent projects with Grumman Butkus Associates?
 - **Yes.**

SUB/ITEM	AMOUNT
Aberdeen Group Inc.	\$ 50,000.00
Wrangler Tech LLC.	\$ 250,000.00
Stevenson Crane	\$ 25,000.00
Siemens	\$ 60,000.00
Insulation	\$ 8,500.00
Material	\$ 15,000.00
Labor	\$ 43,000.00
TOTAL	\$ 451,500.00
BASE BID	\$ 497,350.00
Overhead/Profit	\$ 45,850.00

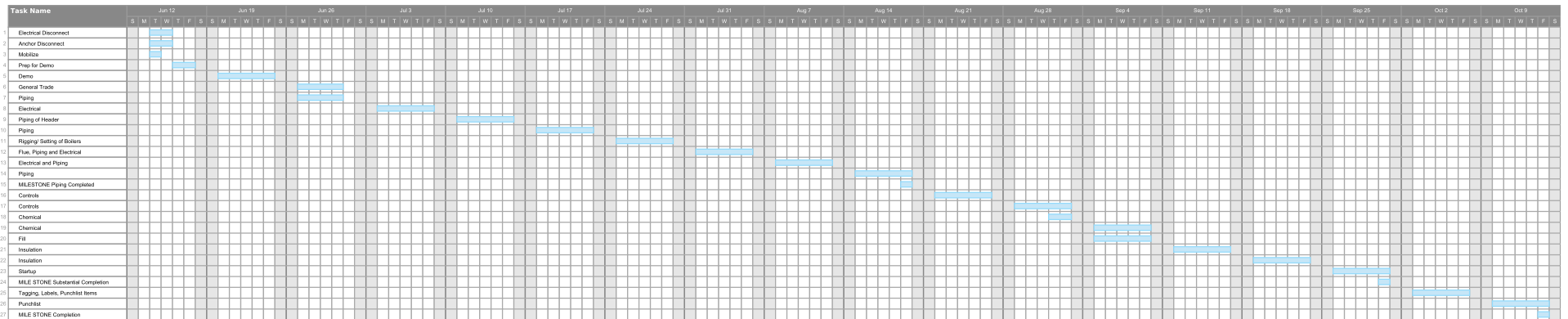

PROJECT MANUAL

**Evanston Public Library
Boiler Replacement**

City of Evanston
Evanston, IL

PROJECT MANUAL CONTENTS

TECHNICAL SPECIFICATIONS

DIVISION 01 - GENERAL REQUIREMENTS

SECTION 01 1100	SUMMARY OF WORK
SECTION 01 3101	MECHANICAL AND ELECTRICAL COORDINATION
SECTION 01 3102	ALTERATION PROJECT PROCEDURES
SECTION 01 3103	STARTING OF SYSTEMS
SECTION 01 3300	SUBMITTALS
SECTION 01 4000	QUALITY CONTROL SERVICES
SECTION 01 6000	MATERIAL AND EQUIPMENT
SECTION 01 7329	CUTTING AND PATCHING
SECTION 01 7700	PROJECT CLOSEOUT

DIVISION 20 - COMMON REQUIREMENTS FOR MECHANICAL, PLUMBING, AND FIRE SUPPRESSION

SECTION 20 0500	BASIC REQUIREMENTS FOR MECHANICAL, PLUMBING, AND FIRE SUPPRESSION
SECTION 20 0501	MINOR MECHANICAL, PLUMBING, AND FIRE SUPPRESSION DEMOLITION
SECTION 20 0513	MOTOR REQUIREMENTS FOR MECHANICAL, PLUMBING, AND FIRE SUPPRESSION EQUIPMENT
SECTION 20 0516	EXPANSION COMPENSATION FOR MECHANICAL, PLUMBING, AND FIRE SUPPRESSION
SECTION 20 0517	PENETRATIONS FOR MECHANICAL, PLUMBING, AND FIRE SUPPRESSION SYSTEMS
SECTION 20 0519	METERS AND GAUGES FOR MECHANICAL, PLUMBING, AND FIRE SUPPRESSION
SECTION 20 0529	HANGERS AND SUPPORTS FOR MECHANICAL, PLUMBING AND FIRE SUPPRESSION SYSTEMS
SECTION 20 0548	VIBRATION ISOLATION FOR MECHANICAL, PLUMBING AND FIRE SUPPRESSION
SECTION 20 0553	IDENTIFICATION FOR MECHANICAL, PLUMBING, AND FIRE SUPPRESSION SYSTEMS
SECTION 20 0700	THERMAL INSULATION FOR MECHANICAL, PLUMBING, AND FIRE SUPPRESSION

DIVISION 23 - MECHANICAL

SECTION 23 0100	COMMON WORK REQUIREMENTS FOR MECHANICAL
SECTION 23 0593	TESTING, ADJUSTING, AND BALANCING FOR HVAC
SECTION 23 0900	BASIC TEMPERATURE CONTROL REQUIREMENTS
SECTION 23 0903	TEMPERATURE CONTROL CONDUIT
SECTION 23 0904	TEMPERATURE CONTROL WIRING
SECTION 23 0906	TEMPERATURE CONTROL DEMOLITION

SECTION 23 0911	CONTROL VALVES
SECTION 23 0912	CONTROL DAMPERS
SECTION 23 0927	TEMPERATURE INSTRUMENTS
SECTION 23 1113	FUEL GAS PIPING
SECTION 23 2113	HYDRONIC PIPING AND SPECIALTIES
SECTION 23 2500	PIPE CLEANING, FLUSHING, AND CHEMICAL TREATMENT
SECTION 23 3113	METAL AND FLEXIBLE DUCT
SECTION 23 5100	BREECHINGS, CHIMNEYS, AND STACKS
SECTION 23 5216	CONDENSING HYDRONIC BOILERS

DRAWINGS (BOUND SEPARATELY)

END OF SECTION

p:\22 projects\p22-1142-00coev\04 design\07 specs\table of contents.docx

SPECIFICATIONS

DIVISION 01 - GENERAL REQUIREMENTS

- SECTION 01 1100 SUMMARY OF WORK
- SECTION 01 3101 MECHANICAL AND ELECTRICAL COORDINATION
- SECTION 01 3102 ALTERATION PROJECT PROCEDURES
- SECTION 01 3103 STARTING OF SYSTEMS
- SECTION 01 3300 SUBMITTALS
- SECTION 01 4000 QUALITY CONTROL SERVICES
- SECTION 01 6000 MATERIAL AND EQUIPMENT
- SECTION 01 7329 CUTTING AND PATCHING
- SECTION 01 7700 PROJECT CLOSEOUT

**SECTION 01 1100
SUMMARY OF WORK**

PART 1 - GENERAL

1.1 SECTION INCLUDES

- A. Scope of work
- B. Contractor use of site and premises
- C. Work sequence
- D. Owner occupancy and utilization

1.2 SCOPE OF WORK

- A. The scope of the project is to replace two existing natural gas fired boilers serving the Evanston Public Library.
- B. The boilers are located on the fourth floor of the library.
- C. New boilers will be high efficiency condensing type.
- D. Scope includes demo of the existing boilers and associated piping, electrical, controls. Installation of new boilers, controls, connection to the existing gas and hot water systems. Provide new gas venting and combustion air ductwork.
- E. Scope includes all modifications to the existing building envelope required for the boiler installation including roofing, exterior wall modification and patching and existing louver modification.

1.3 CONTRACTOR USE OF SITE AND PREMISES

- A. Limit use of site and premises to allow:
 - 1. Owner occupancy.
 - 2. Use of premises by Owner to conduct normal activities.
- B. Tie-ins to existing systems must be done in a manner so as to minimize interference with the Owner's operations (i.e., during premium time).
- C. Access to Site: Limited to areas of work.
- D. Emergency Building Exits During Construction: Emergency exits should not be blocked during construction at any time.
- E. Construction Operations: Limited areas noted on drawings; primarily the boiler room and adjacent spaces.
- F. Time Restrictions for Performing Work: Substantial Completion by Labor Day 2023.
- G. Utility Outages and Shutdown: 72 hours' notice; outside of Library operating hours.

1.4 WORK SEQUENCE

- A. Install work to accommodate Owner's occupancy requirements during the construction period. Coordinate mechanical or electrical schedule and operations with Owner.

1.5 OWNER OCCUPANCY AND UTILIZATION

- A. Owner will occupy the premises during the entire period of construction for the conduct of normal operations.
- B. Cooperate with Owner to minimize conflict and to facilitate Owner's operations.
- C. Schedule the Work to accommodate this requirement.

PART 2 - PRODUCTS

Not Applicable

PART 3 - EXECUTION

Not Applicable

END OF SECTION

P:\22 Projects\22-1142-00coev\04 Design\07 Specs\Div 01\01 1100-Summary of Work.docx

**SECTION 01 3101
MECHANICAL AND ELECTRICAL COORDINATION**

PART 1 - GENERAL

1.1 SECTION INCLUDES

- A. Mechanical and Electrical Coordination
- B. Submittals
- C. Coordination required
- D. Coordination documents
- E. Coordination of submittals
- F. Coordination of substitutions and modifications
- G. Observation of Work
- H. Documentation
- I. Equipment start up
- J. Inspection and acceptance of equipment

1.2 MECHANICAL AND ELECTRICAL WORK COORDINATION

- A. Provide coordination for the type of mechanical and electrical work required for this Project for the duration of the Work.

1.3 SUBMITTALS

- A. Submit any coordination documents prior to submitting shop drawings, product data and samples.

1.4 COORDINATION REQUIRED

- A. Coordinate mechanical and electrical work of Divisions 20, 23, 26, with work of each other and of other Divisions.
- B. Coordinate progress schedules, including dates for submittals and for delivery of products.
- C. Conduct conferences among Subcontractors and others concerned with the Work to establish and maintain coordination and schedules and to resolve coordination matters in dispute.
- D. Confer with other Contractors regarding location and size of pipes, equipment, fixtures, conduit, ducts, openings, switches, outlets, fire sprinkler heads, fire hose cabinets, etc., in progress of the work of any Contractor project. Architectural Drawings shall take precedence over Mechanical and Electrical Drawings.
- E. Where work connects to that of another trade or to piping or equipment in place, make measurements in field to make connection work come true and line up with item being connected.
- F. Where work specified under other Divisions of Specifications connects to equipment, which is part of Divisions 20, , 23, 26provide proper connection(s) to such equipment.
- G. Participate in progress meetings. Report on progress of Work to be adjusted under coordination requirements and any required changes in schedules. Transmit minutes of meetings and reports to concerned parties.

1.5 COORDINATION OF SUBMITTALS

- A. Review shop drawings, product data and samples for compliance with Contract Documents and for coordination among work of all sections of the Project Manual. Transmit to Contractor for review, then transmit to Engineer.
- B. Check field dimensions and clearances and relationship to available space and anchors.
- C. Check compatibility with equipment and Work of other sections, electrical characteristics and operational control requirements.
- D. Check motor voltages and control characteristics.
- E. Coordinate controls, interlocks, wiring of pneumatic switches and relays.
- F. Coordinate wiring and control diagrams.
- G. Review the effect of any changes on work of other sections.
- H. Verify and coordinate maintenance of Record Documents.

1.6 COORDINATION OF SUBSTITUTIONS AND MODIFICATIONS

- A. Review proposals and requests from subcontractors.
- B. Verify compliance with Contract Documents and for compatibility with Work and Products of other sections.
- C. Submit to Engineer with recommendation for action.

1.7 OBSERVATION OF WORK

- A. Observe Work for compliance with Contract Documents.

1.8 DOCUMENTATION

- A. Observe and maintain a record of tests. Record:
 - 1. Specification section number, product and name of Subcontractor.
 - 2. Name of testing agency and name of inspector.
 - 3. Name of manufacturer's representative present.
 - 4. Date, time and duration of tests.
 - 5. Type of test and results.
 - 6. Retesting required.
- B. Assemble background documentation for dispute and claim settlement by Engineer.
- C. Submit copies of documentation to Engineer upon request.

1.9 EQUIPMENT START UP

- A. Verify utilities, connections and controls are complete and equipment is in operable condition as required by Division 01 Section 01 3103, "Starting of Systems."
- B. Observe start-up and adjustments; record time and date of startup and results.
- C. Observe equipment demonstrations to Owner; record times and additional information required for Operation and Maintenance Manuals.

1.10 INSPECTION AND ACCEPTANCE OF EQUIPMENT

- A. Prior to inspection, verify that equipment is tested and operational and clean.
- B. Assist Engineer with inspection. Prepare list of items to be completed and corrected.

PART 2 - PRODUCTS

Not Applicable

PART 3 - EXECUTION

Not Applicable

END OF SECTION

P:\22 Projects\22-1142-00coev\04 Design\07 Specs\Div 01\01 3101-Mechanical & Electrical Coordination.docx

**SECTION 01 3102
ALTERATION PROJECT PROCEDURES**

PART 1 - GENERAL

1.1 SECTION INCLUDES

- A. Demolition, alterations, cutting and protection
- B. Products and installation for patching and extending Work
- C. Transition and adjustments
- D. Repair of damaged surfaces, finishes and cleaning

1.2 SEQUENCE AND SCHEDULES

- A. Schedule work in sequences and within times specified in Division 01 Section 01 0000, "Summary of Work."
- B. Submit separate detailed sub-schedule for alterations work, coordinated with Master Construction Schedule. Show:
 - 1. Each stage of work; occupancy dates of areas
 - 2. Date of Substantial Completion for each area of alteration work
 - 3. Crafts and subcontractors employed in each stage
- C. Schedule noisy or hazardous work to avoid problems with Owner's operations.

1.3 DEMOLITION, ALTERATIONS, CUTTING AND PROTECTION

- A. Assign demolition, moving, removal, cutting and patching work to crafts qualified to perform work in manner to cause least damage to each type of work and provide means of restoring surfaces to appearance of new work.
- B. Perform cutting and removal work to remove minimum necessary and in manner to avoid damage to adjacent work.
 - 1. Cut finish surfaces such as masonry, tile, plaster or metals by methods to terminate surfaces in straight line at natural point of division.
- C. Perform cutting and patching as specified in Division 01 Section 01 7329, "Cutting and Patching."
- D. Protect existing finishes, equipment and adjacent work which are scheduled to remain from damage.
 - 1. Protect existing and new work from weather and temperature extremes.
 - a. Maintain existing interior work above 60°F.
 - b. Provide weather protection, waterproofing, heat and humidity control to prevent damage to remaining existing work and to new work.
- E. Provide temporary enclosures to separate work areas from existing building and from areas occupied by Owner and to provide weather protection.

PART 2 - PRODUCTS

2.1 SALVAGED MATERIALS

- A. Salvage sufficient quantities of cut or removed materials to replace damaged work of existing construction, when material is not readily obtainable on current market.
- B. Store salvaged items in a dry, secure place on site.
- C. Items not specified for use in repair work remain property of Owner.
- D. Do not use salvaged or used material in new construction except with prior written authorization from Engineer.

2.2 PRODUCTS FOR PATCHING AND EXTENDING WORK

- A. Ensure that work is complete.
- B. Provide same materials or types of construction as that in existing structure, to patch, extend or match existing work.
 - 1. Contract Documents may not define products or standards of workmanship present in existing construction.
 - 2. Determine products by inspection and testing.
 - 3. Determine workmanship by use of existing as sample of comparison.
- C. Presence of a product, finish or type of construction requires that patching, extending or matching be performed to make work complete and consistent to identical quality standards.

PART 3 - EXECUTION

3.1 EXAMINATION (PRE-DEMOLITION)

- A. Verify if all hazardous waste materials (asbestos, PCB/transformers, etc.) have been removed from work areas. If this is not verified, notify Owner/Engineer in writing.
- B. Demolition Drawings are based on casual field observation and existing record documents. Review site conditions and report discrepancies to Engineer before disturbing existing installation.
- C. Beginning of demolition work means acceptance of existing conditions.

3.2 PERFORMANCE

- A. Patch and extend existing work using skilled craftsmen capable of matching existing quality of workmanship. For patched or extended work, provide quality equal to that specified for new work.

3.3 PREPARATION

- A. Cut, move, or remove items as necessary for access to alterations and renovation Work. Replace and restore at completion.
- B. Remove unsuitable material not marked for salvage, such as rotted wood, corroded metals and deteriorated masonry and concrete. Replace materials as specified for finished Work.
- C. If, during course of project, hazardous materials are in any way suspected, including but not limited to asbestos, pollutants, or PCB, inform Owner immediately and suspend action on that portion of work.

- D. Remove or repair dangerous or unsanitary conditions.
- E. Remove debris and abandoned items from area and from concealed spaces.
- F. Remove abandoned piping, conduit and wiring.
- G. Prepare surface and remove surface finishes to provide for proper installation of new work and finishes.
- H. Close openings in exterior surfaces to protect existing work and salvage items from weather and extremes of temperature and humidity. Insulate ductwork and piping to prevent condensation in exposed areas.

3.4 EXAMINATION (PRE-INSTALLATION)

- A. Verify that demolition is complete, and areas are ready for installation of new Work.
- B. Beginning of restoration Work means acceptance of existing conditions.

3.5 INSTALLATION

- A. Coordinate work of alterations and renovations to expedite completion sequentially and to accommodate Owner occupancy.

Project: Complete in all respects including operational mechanical and electrical work as well as roofing and building enclosure work.
- B. Remove, cut and patch Work in a manner to minimize damage and to provide a means of restoring Products and finishes to original condition.
- C. Refinish visible existing surfaces to remain in renovated rooms and spaces, to specified condition for each material, with a neat transition to adjacent finishes.
- D. In addition to specified replacement of equipment restore existing plumbing, heating, ventilation, air conditioning, and electrical, systems to full operational condition.
- E. Install Products as specified in individual Sections of Divisions 20, 21, 22, 23, 26, 27, and 28.

3.6 TRANSITIONS

- A. Where new Work abuts or aligns with existing, perform a smooth and even transition. Patched Work to match existing adjacent Work in texture and appearance.
- B. When finished surfaces are cut so that a smooth transition with new work is not possible, terminate existing surface along a straight line at a natural line of division and make recommendation to Engineer.

3.7 ADJUSTMENTS

- A. Where removal of partitions or walls results in adjacent spaces becoming one, rework floors, walls and ceilings to a smooth plane without breaks, steps, or bulkheads.
- B. Where a change of plane of ¼" or more occurs, submit recommendation for providing a smooth transition for Engineer review.
- C. Fit work at penetrations of surfaces as specified in Division 01 Section 01 7329, "Cutting and Patching."

3.8 REPAIR OF DAMAGED SURFACES

- A. Patch or replace portions of existing surfaces which are damaged, lifted, discolored, or showing other imperfections. This includes pipe covering, equipment and duct insulation.
- B. Repair substrate prior to patching finish.

3.9 FINISHES

- A. Finish patches to product uniform finish and texture over entire area. When finish cannot be matched, refinish entire surface to nearest intersections.

3.10 CLEANING

- A. Perform construction cleaning as specified in Division 01 Section 01 7700, "Project Closeout."
 - 1. Clean Owner occupied areas daily.
 - 2. Clean all spillage, overspray and heavy dust collections in Owner occupied areas immediately.
- B. At completion of work of each craft, clean area and make surfaces ready for work of successive crafts.
- C. At completion of alterations work in each area, provide final cleaning in accord with Section 01700 and return space to a condition suitable for use of Owner.

END OF SECTION

P:\22 Projects\P22-1142-00coev\04 Design\07 Specs\Div 01\01 3102-Alteration Project Procedures.docx

**SECTION 01 3103
STARTING OF SYSTEMS**

PART 1 - GENERAL

1.1 SECTION INCLUDES

- A. Starting systems
- B. Demonstration and instructions
- C. Testing, adjusting, and balancing

1.2 STARTING SYSTEMS

- A. Coordinate schedule for start up of various equipment and systems.
- B. Notify Engineer and Owner 7 calendar days prior to startup of each item.
- C. Verify that each piece of equipment or system has been checked for proper lubrication, drive rotation, belt tension, control sequence, or other conditions which may cause damage.
- D. Verify that tests, meter readings and specified electrical characteristics agree with those required by the equipment or system manufacturer.
- E. Verify wiring and support components for equipment are complete and tested.
- F. Verify utilities, connections and controls are complete and equipment is in operable condition.
- G. Observe start-up and adjustments: Record time and date of start-up and results.
- H. Observe equipment demonstrations to Owner: Record times and additional information required for Operation and Maintenance Manuals.
- I. Execute start up under supervision of responsible manufacturer's representative in accordance with manufacturers' instructions.
- J. When specified in individual specification Sections, require manufacturer to provide authorized representative to be present at site to inspect, check and approve equipment or system installation prior to start up and to supervise placing equipment or system in operation.
- K. Submit a written report that equipment or system has been properly installed and is functioning correctly.

1.3 DEMONSTRATION AND INSTRUCTIONS

- A. Demonstrate operation and maintenance of Products to Owner's personnel two weeks prior to date of Substantial Completion.
- B. Demonstration and instructions shall be provided by a qualified manufacturers' representative who is knowledgeable about the Project.
- C. Utilize operation and maintenance manuals as basis for instruction. Review contents of manual with Owners' personnel in detail to explain all aspects of operation and maintenance.
- D. Demonstrate start up, operation, control, adjustment, trouble shooting, servicing, maintenance and shutdown of each item of equipment.
- E. Prepare and insert additional data in operations and maintenance manuals when need for additional data becomes apparent during instruction.

- F. The amount of time required for instruction on each item of equipment and system is that specified in individual sections.

1.4 INSPECTION AND ACCEPTANCE OF EQUIPMENT

- A. Prior to inspection, verify that equipment is tested, operational and clean.
- B. Assist Engineer with inspection. Prepare list of items to be completed and corrected.

1.5 TESTING, ADJUSTING AND BALANCING

The contractor will appoint, employ and pay for services of an independent firm to perform testing, adjusting and balancing.

The independent firm will perform services specified in Division 23 Section 23 0593, "Testing, Adjusting, and Balancing for HVAC," except for factory tests.

- A. Reports will be submitted by the independent firm to the Engineer indicating observations and results of tests and indicating compliance or non-compliance with specified requirements and with the requirements of the Contract Documents.

1.6 ADJUSTING

- A. Adjust operating products and equipment to ensure smooth and unhindered operation.

PART 2 - PRODUCTS

Not Applicable

PART 3 - EXECUTION

Not Applicable

END OF SECTION

P:\22 Projects\P22-1142-00coev\04 Design\07 Specs\Div 01\01 3103-Starting of Systems.docx

**SECTION 01 3300
SUBMITTALS**

PART 1 - GENERAL

1.1 SECTION INCLUDES

- A. Submittal procedures
- B. Proposed products list
- C. Contractor-prepared shop drawings
- D. Product data
- E. Samples
- F. Manufacturers' instructions
- G. Manufacturers' certificates

1.2 SUBMITTAL PROCEDURES

- A. Refer also to provisions of the General Conditions.
- B. Identify Project, Contractor, Subcontractor or supplier; pertinent Drawing sheet, equipment tag, system designation number(s) and specification Section number, as appropriate.
- C. Where possible, submit shop drawings and product data grouped to include complete submittals of related systems, products and accessories in a single submittal so long as this does not delay individual items whose review is time-critical.
- D. If only part of required drawings in one group are submitted, action will be withheld on them until remaining drawings are submitted.
- E. Catalog cuts showing more than one model of a product shall be clearly marked indicating which model is being proposed.
- F. Capacity and performance data shall be given in same form, units and completeness presented in Contract Documents.
- G. Identifying symbols and tags used on drawings shall be clearly cross-referenced on shop drawings.
- H. Identify room names and numbers in which various products will be used.
- I. Schedule submittals to expedite the Project and deliver to Engineer electronically.
- J. Mark in units to match those specified.
- K. Provide space for Contractor and Engineer review stamps.
- L. Apply Contractor's stamp, certifying that review, verification of Products required, field dimensions, adjacent construction Work and coordination of information is in accordance with the requirements of the Work and Contract Documents.
- M. Identify variations from Contract Documents and Product or system limitations which may be detrimental to successful performance of the completed Work.
- N. Revise and resubmit submittals as required, identifying all changes made since previous submittal.
- O. Distribute copies of reviewed submittals to concerned parties. Instruct parties to promptly report any inability to comply with provisions.

1.3 CONSTRUCTION PROGRESS SCHEDULES

- A. Submit estimated progress schedule in duplicate within 15 business days after date of Owner-Contractor Agreement for Engineer review.
- B. Revise and resubmit as required.
- C. Revise and resubmit work schedule affected by accepted alternates.

1.4 PROPOSED PRODUCTS LIST

- A. Within 15 business days after date of Owner's Contract Agreement submit complete list of major products proposed for use, with name of manufacturer, trade name and model number of each product.
- B. For products specified only by reference standards, give manufacturer, trade name, model or catalog designation and reference standards.
- C. Mark dimensions and values in units to match those specified.

1.5 CONTRACTOR-PREPARED SHOP DRAWINGS

- A. Shop drawings to be submitted electronically in .pdf format.
- B. Submit ¼" scale floor plans indicating proposed routing of new piping and duct systems, new and relocated equipment locations and connection points to existing services including sections through equipment and piping diagrams of all connections.
- C. Identify equipment, column lines, etc., with designations shown on Contract Documents.
- D. After review, distribute in accordance with Article on Procedures above and provide copies for Record Documents described in Division 01 Section 01 7700, "Project Closeout."

1.6 PRODUCT DATA

- A. Submit the number of hard copies as established at the preconstruction conference. Alternatively, shop drawings may be submitted electronically in .pdf format.
- B. Mark each copy to identify applicable products, models, systems, equipment tags and other data. Supplement manufacturers' standard data to provide information unique to this Project.
- C. After review, distribute in accordance with Article on Procedures above and provide copies for Record Documents described in Division 01 Section 01 7700, "Project Closeout."

1.7 MANUFACTURER'S INSTRUCTIONS

- A. When specified in individual specification Sections, submit manufacturers' printed instructions for [delivery, storage, assembly, installation, start up, adjusting, testing, in quantities specified for Product Data.
- B. Identify conflicts between manufacturers' instructions and Contract Documents.

1.8 MANUFACTURER'S CERTIFICATES

- A. When specified in individual specification Sections, submit manufacturer's certificate to Engineer for review in quantities specified for Product Data.
- B. Indicate that material or product conforms to or exceeds specified requirements. Submit supporting reference data, affidavits and certifications as appropriate.

- C. Certificates may be recent or previous test results on material or Product but must be acceptable to Engineer.

PART 2 - PRODUCTS

Not Applicable

PART 3 - EXECUTION

Not Applicable

END OF SECTION

P:\22 Projects\P22-1142-00coev\04 Design\07 Specs\Div 01\01 3300-Submittals.docx

SECTION 01 4000
QUALITY CONTROL SERVICES

PART 1 - GENERAL

1.1 SECTION INCLUDES

- A. Quality assurance and control of installation
- B. References
- C. Manufacturers' field services and reports

1.2 QUALITY ASSURANCE/CONTROL OF INSTALLATION

- A. Monitor quality control over suppliers, manufacturers, Products, services, site conditions and workmanship to produce Work of specified quality.
- B. Comply fully with manufacturers' instructions, including each step in sequence.
- C. Should manufacturers' instructions conflict with Contract Documents, request clarification from Engineer before proceeding.
- D. Comply with specified standards as a minimum quality for the Work except when more stringent tolerances, codes or specified requirements indicate higher standards or more precise workmanship.
- E. Work to be performed by persons qualified to produce workmanship of specified quality.
- F. Secure Products in place with positive anchorage devices designed and sized to withstand stresses, vibration, physical distortion or disfigurement.

1.3 REFERENCES

- A. Conform to reference standard by date of issue current on date of Contract Documents when there are no Bids date specified in product Sections.
- B. Obtain copies of standards when required by Contract Documents.
- C. Should specified reference standards conflict with Contract Documents, request clarification from Engineer before proceeding.
- D. The contractual relationship of the parties to the Contract shall not be altered from the Contract Documents by mention or inference otherwise in any reference document.

1.4 MANUFACTURERS' FIELD SERVICES, FIELD TESTS AND REPORTS

- A. When specified in individual specification Sections, Contractor shall require material or Product suppliers, Subcontractors, or manufacturers to provide qualified staff personnel to observe site conditions; testing; conditions of installation; quality of workmanship; start-up of equipment; testing, adjusting and balancing of equipment and materials; and troubleshooting as applicable B and to initiate instructions when necessary. Submit report per paragraph C below, this section.
- B. Report observations and site decisions or instructions given to Owner, applicators or installers that are supplemental or contrary to manufacturers' written instructions.
- C. Submit written report in duplicate within 10 days of observation, start-up, testing, etc. to Engineer for review.

PART 2 - PRODUCTS

Not Applicable

PART 3 - EXECUTION

Not Applicable

END OF SECTION

P:\22 Projects\P22-1142-00coev\04 Design\07 Specs\Div 01\01 4000-Quality Control Services.docx

**SECTION 01 6000
MATERIAL AND EQUIPMENT**

PART 1 - GENERAL

1.1 SECTION INCLUDES

- A. Products
- B. Transportation and handling
- C. Storage and protection
- D. Product options
- E. Substitutions

1.2 PRODUCTS

- A. Products: Means new material, machinery, components, equipment, fixtures and systems forming the Work. Does not include machinery and equipment used for preparation, fabrication, conveying and erection of the Work. Products may also include existing materials or components required for reuse.
- B. Do not use materials and equipment removed from existing premises, except as specifically permitted by the Contract Documents.
- C. Provide interchangeable components of the same manufacturer for similar components.

1.3 TRANSPORTATION AND HANDLING

- A. Transport and handle products in accordance with manufacturer's instructions.
- B. Promptly inspect shipments to assure that products comply with requirements, quantities are correct and products are undamaged.
- C. Provide equipment and personnel to handle products by methods to prevent soiling, disfigurement or damage.

1.4 STORAGE AND PROTECTION

- A. Store and protect products in accordance with manufacturer's instructions, with seals and labels intact and legible. Store sensitive products in weather tight, climate-controlled enclosures.
- B. For exterior storage of fabricated products, place on sloped supports above ground.
- C. Provide off site storage and protection when site does not permit on site storage or protection.
- D. Cover products subject to deterioration with impervious sheet covering. Provide ventilation to avoid condensation.
- E. Store loose granular materials on solid flat surfaces in a well-drained area. Prevent mixing with foreign matter.
- F. Provide equipment and personnel to store products by methods to prevent soiling, disfigurement or damage.
- G. Arrange storage of products to permit access for inspection. Periodically inspect to assure products are undamaged and are maintained under specified conditions.

1.5 PRODUCT OPTIONS

- A. Products Specified by Reference Standards or by Description Only: Any product meeting those standards or description.
- B. Products Specified by Naming One or More Manufacturers: Products of manufacturers named and meeting specifications; no options or substitutions allowed.
- C. Product Specified by Naming One Manufacturer as a Base and Naming Others as Acceptable: Obligations listed in the following "Substitutions" paragraph apply when an "Acceptable Other" is used. Manufacturer named on the drawings and in equipment scheduling are to be considered as a Base; with respect to the particular product described, other manufacturers named in those documents are acceptable others.
- D. When an "Acceptable Other" manufacturer is used in lieu of Specified, Contractor shall coordinate mechanical, plumbing and electrical requirements and will bear any additional costs required by other subcontractors as a result of the proposed product.

1.6 SUBSTITUTIONS

- A. Engineer will consider requests for Substitutions only within 15 days after date established in Notice to Proceed. See Division 01 Section 01 3300, "Submittals."
- B. Substitutions may be considered when a product becomes unavailable through no fault of the Contractor.
- C. Document each request with complete data substantiating compliance of proposed Substitution with Contract Documents.
- D. A request constitutes a representation that the Contractor:
 - 1. Has investigated proposed product and determined that it meets or exceeds the quality level of the specified product.
 - 2. Will provide the same warranty for the Substitution as for the specified product.
 - 3. Will coordinate installation and make changes to other Work which may be required for the Work to be complete with no additional cost to Owner.
 - 4. Has investigated that the proposed product can be installed in the space available with access for servicing and maintenance.
 - 5. Has coordinated mechanical, plumbing and electrical requirements and will bear any additional costs required by other subcontractors as a result of the proposed product.
 - 6. Waives claims for additional costs or time extension which may subsequently become apparent.
 - 7. Will reimburse Owner for review or redesign services associated with re approval by authorities.
- E. Substitutions will not be considered when they are indicated or implied on shop drawing or product data submittals, or when acceptance will require revision to the Contract Documents.
- F. Substitution Submittal Procedure:
 - 1. Submit a request for Substitution for consideration. Limit each request to one proposed Substitution.
 - 2. Submit shop drawings, product data and certified test results attesting to the proposed product equivalence.

3. The Engineer will notify the Contractor, in writing, of decision to accept or reject request.

PART 2 - PRODUCTS

Not Applicable

PART 3 - EXECUTION

Not Applicable

END OF SECTION

P:\22 Projects\22-1142-00coev\04 Design\07 Specs\Div 01\01 6000-Material and Equipment.docx

**SECTION 01 7329
CUTTING AND PATCHING**

PART 1 - GENERAL

1.1 SECTION INCLUDES

- A. Requirements and limitations for cutting and patching of Work.

1.2 SUBMITTALS

- A. Submit written request in advance of cutting or alteration which affects:
 - 1. Structural integrity of any element of Project
 - 2. Integrity of weather exposed or moisture resistant element
 - 3. Efficiency, maintenance, or safety of any operational element
 - 4. Visual qualities of sight exposed elements
 - 5. Work of Owner or separate contractor
- B. Include in request:
 - 1. Effect on work of Owner or separate contractor
 - 2. Written permission of affected separate contractor
 - 3. Identification of Project
 - 4. Location and description of affected work
 - 5. Necessity for cutting or alteration
 - 6. Description of proposed work and products to be used
 - 7. Alternatives to cutting and patching
 - 8. Effect on work of Owner or separate contractor
 - 9. Written permission of affected separate contractor
 - 10. Date and time work will be executed

PART 2 - PRODUCTS

2.1 MATERIALS

- A. Primary Products: Those required for original installation.

PART 3 - EXECUTION

3.1 EXAMINATION

- A. Inspect existing conditions prior to commencing Work, including elements subject to damage or movement during cutting and patching.
- B. After uncovering existing work, inspect conditions affecting performance of work.
- C. Beginning of cutting or patching means acceptance of existing conditions.

3.2 PREPARATION

- A. Provide temporary supports to ensure structural integrity of the Work. Provide devices and methods to protect other portions of Project from damage.
- B. Provide protection from elements for areas which may be exposed by uncovering work.
- C. Maintain excavations free of water.

3.3 CUTTING AND PATCHING

- A. Execute cutting, fitting and patching to complete work.
- B. Fit products together, to integrate with other work.
- C. Uncover work to install ill-timed work.
- D. Remove and replace defective or non-conforming work.
- E. Provide openings in the work for penetration of mechanical and electrical work.

3.4 PERFORMANCE

- A. Execute work by methods to avoid damage to other Work and which will provide appropriate surfaces to receive patching and finishing.
- B. Employ original installer to perform cutting and patching for weather exposed and moisture resistant elements and sight exposed surfaces.
- C. Cut rigid materials using masonry saw or core drill. Pneumatic tools not allowed without prior approval.
- D. Restore work with new products in accordance with requirements of Contract Documents.
- E. Fit work air tight to pipes, sleeves, ducts, conduit and other penetrations through surfaces.
- F. At penetrations of fire rated walls, partitions, ceiling, or floor construction, completely seal voids with fire rated material in accordance with Division 20 Section 20 0517, "Penetrations for Mechanical, Plumbing, and Fire Suppression," to full thickness of the penetrated element.
- G. Refinish surfaces to match adjacent finish. For continuous surfaces, refinish to nearest intersection or natural break. For an assembly, refinish entire unit.

END OF SECTION

P:\22 Projects\22-1142-00coev\04 Design\07 Specs\Div 01\01 7329-Cutting and Patching.docx

**SECTION 01 7700
PROJECT CLOSEOUT**

PART 1 - GENERAL

1.1 SECTION INCLUDES

- A. Closeout procedures
- B. Final cleaning
- C. Adjusting
- D. Project record documents
- E. Operation and maintenance data
- F. Warranties
- G. Spare parts and maintenance materials

1.2 CLOSEOUT PROCEDURES

- A. Submit written certification that Contract Documents have been reviewed, Work has been inspected and that Work is complete in accordance with Contract Documents and ready for inspection by Engineer.
- B. Provide submittals to Engineer that are required by governing or other authorities.
- C. Submit final Application for Payment identifying total adjusted Contract Sum, previous payments, and sum remaining due.
- D. Owner will occupy all of the building as specified in Division 01 Section 01 1100, "Summary of Work."

1.3 FINAL CLEANING

- A. Execute final cleaning prior to final inspection.
- B. Clean interior and exterior glass and surfaces exposed to view; remove temporary labels, stains, and foreign substances; polish transparent and glossy surfaces; vacuum carpeted and soft surfaces.
- C. Clean equipment and fixtures to a sanitary condition.
- D. Replace strainers and replace filters of operating equipment affected by new installation.
- E. Clean debris from roofs, gutters, downspouts, and drainage systems.
- F. Clean site; sweep paved areas, rake clean landscaped surfaces affected by installation.
- G. Remove waste and surplus materials, rubbish and any construction facilities and equipment from the site.]

1.4 ADJUSTING

- A. Adjust operating Products and equipment to ensure smooth and unhindered operation.

1.5 PROJECT RECORD DOCUMENTS

- A. Maintain on site, one set of the following record documents; record actual revisions to the Work:
 - 1. Contract Drawings

2. Specifications
 3. Addenda
 4. Change Orders and other Modifications to the Contract
 5. Reviewed shop drawings, product data, and samples
- B. Store Record Documents separate from documents used for construction.
- C. Record information concurrent with construction progress.
- D. Specifications: Legibly mark and record at each Product section description of actual Products installed, including the following:
1. Manufacturer's name and product model and number
 2. Product substitutions or alternates utilized
 3. Changes made by Addenda and Modifications
- E. Record Documents and Shop Drawings: Legibly mark each item to record actual construction including:
1. Measured locations of internal utilities and appurtenances concealed in construction, referenced to visible and accessible features of the Work
 2. Field changes of dimension and detail
 3. Details not on original Contract Drawings
- F. Submit changes to Record Documents in AutoCAD format.
- G. Delete Engineer title block and seal from all documents.
- H. Submit documents to Engineer with claim for final Application for Payment.

1.6 OPERATION AND MAINTENANCE DATA

- A. Quality Assurance
1. Instructions and data are to be prepared by personnel experienced in maintenance and operation of described products in .pdf format.
- B. Internally index the .pdf contents with page dividers, logically organized as described below with tab titling clearly printed under reinforced laminated plastic tabs.
- C. Contents: Prepare a Table of Contents for each volume, with each Product or System description identified.
- D. Part 1: Directory listing names, addresses, and telephone numbers of Engineer, Contractor, Subcontractors and major equipment suppliers.
- E. Part 2: Operation and maintenance instructions, arranged by system and subdivided by component. For each category, identify names, addresses, and telephone numbers of Subcontractors and suppliers. Identify the following:
1. Significant design criteria.
 2. List of equipment.
 3. Parts list for each component.
 4. Operating instructions.

5. Maintenance instructions for equipment and systems.
 6. Maintenance instructions for special finishes, including recommended cleaning methods and materials and special precautions identifying detrimental agents.
- F. Part 3: Project documents and certificates, including the following:
1. Shop drawings and product data.
 2. Air and water balance reports.
 3. Certificates.
 4. Photocopies of warranties.
- G. Submit one copy of completed volumes in final form 15 days prior to final inspection. This copy will be returned after final inspection with Engineer comments. Revise content of documents as required prior to final submittal.
- H. Submit final volumes revised within ten days after final inspection.

1.7 WARRANTIES

- A. Provide duplicate notarized copies.
- B. Execute and assemble documents from Subcontractors, suppliers and manufacturers.
- C. Provide Table of Contents and assemble in 3-D side ring binder with durable cover.
- D. Submit prior to final Application for Payment.
- E. For items of Work delayed beyond date of Substantial Completion, provide updated submittal within ten days after acceptance, listing date of acceptance as start of warranty period.

1.8 SPARE PARTS AND MAINTENANCE MATERIALS

- A. Provide products, spare parts, maintenance and extra materials in quantities specified in individual specification Sections.
- B. Deliver to Project site and place in location as directed]; obtain receipt from Owner prior to final payment.

PART 2 - PRODUCTS

Not Applicable

PART 3 - EXECUTION

Not Applicable

END OF SECTION

P:\22 Projects\122-1142-00coev\04 Design\07 Specs\Div 01\01 7700-Project Closeout.docx

SPECIFICATIONS

DIVISION 20 – COMMON REQUIREMENTS FOR MECHANICAL, PLUMBING, AND FIRE SUPPRESSION

SECTION 20 0500	BASIC REQUIREMENTS FOR MECHANICAL, PLUMBING, AND FIRE SUPPRESSION
SECTION 20 0501	MINOR MECHANICAL, PLUMBING, AND FIRE SUPPRESSION DEMOLITION
SECTION 20 0513	MOTOR REQUIREMENTS FOR MECHANICAL, PLUMBING, AND FIRE SUPPRESSION EQUIPMENT
SECTION 20 0516	EXPANSION COMPENSATION FOR MECHANICAL, PLUMBING, AND FIRE SUPPRESSION
SECTION 20 0517	PENETRATIONS FOR MECHANICAL, PLUMBING, AND FIRE SUPPRESSION SYSTEMS
SECTION 20 0519	METERS AND GAUGES FOR MECHANICAL, PLUMBING, AND FIRE SUPPRESSION
SECTION 20 0529	HANGERS AND SUPPORTS FOR MECHANICAL, PLUMBING AND FIRE SUPPRESSION SYSTEMS
SECTION 20 0548	VIBRATION ISOLATION FOR MECHANICAL, PLUMBING AND FIRE SUPPRESSION
SECTION 20 0553	IDENTIFICATION FOR MECHANICAL, PLUMBING, AND FIRE SUPPRESSION SYSTEMS
SECTION 20 0700	THERMAL INSULATION FOR MECHANICAL, PLUMBING, AND FIRE SUPPRESSION

SECTION 20 0500
BASIC REQUIREMENTS FOR MECHANICAL, PLUMBING, AND FIRE SUPPRESSION

PART 1 - GENERAL

1.1 SECTION INCLUDES

- A. Basic mechanical requirements specifically applicable to Divisions 20, 21, 22, and 23.

1.2 DEFINITIONS

- A. The following words or phrases have special meaning when used in the article (of the division and in any other requirement) applicable to this discussion:
1. "Exposed to View" or "Exposed" — shall have reference to and mean that the pipes, ducts, etc., insulated or otherwise, in the completed structure are visible within any normally occupied space, room or area.
 2. "In Concealed Spaces", "Concealed" or "Not Exposed to View" — shall have reference to and mean that the pipes, duct, etc., insulated or otherwise are concealed and not exposed to view within furred spaces, above suspended ceilings, pipe chases, etc.
 3. "Unfinished Spaces" or "Unfinished Rooms" — shall have reference to areas such as Machine Rooms, Equipment Rooms, or similar areas. Where the words "In Finished Areas" or "Finished Rooms" are used, it shall have reference to rooms or spaces, such as, Reading rooms, Offices, Public Corridors, etc.
 4. "Finished Rooms or Spaces" shall refer to areas similar to offices, public corridors, and public toilet rooms.
 5. "Provide" — shall be taken to mean "furnish and install" meaning to purchase and deliver to the job site and the installation thereof.
 6. "Piping" — shall include, in addition to pipe all fittings, valves, hangers, and other supports, expansion compensators, anchors, and accessories related to such piping including associated insulation.
 7. "Ductwork" — shall include, in addition to ducts, all fittings, transitions, dampers, hangers and other supports, fire dampers, access panels, associated insulation and accessories related to such ductwork.
 8. "Contractor" in Specifications and Drawing refers to respective Contractor performing that portion of work.
 9. "Invert Elevation" (I.E.) means elevation of inside bottom of pipe or duct.
 10. "Mechanical Work" is work in Divisions 20, 21, 22, and 23.
 - a. NOTE: The words "Contractor shall" are implied and shall be so understood wherever the directions "furnish," "install" or "provide" are used.

1.3 SPECIAL CONDITIONS

- A. Minor items and accessories or devices reasonably inferable as necessary to the complete and proper operation of any system shall be provided by the Contractor for such system whether or not they are specifically called for by the Specifications or Drawings.

- B. Where work specified in other sections of the specifications connects to equipment specified in Divisions 20, 21, 22, and 23 Sections, check the required connection to such equipment.

1.4 WORK BY OWNER

- A. None

1.5 OWNER-FURNISHED PRODUCTS

- A. None

1.6 PROJECT/SITE CONDITIONS

- A. Install Work in locations shown on Drawings, unless prevented by Project conditions.
- B. Prepare drawings showing proposed rearrangement of Work to meet Project conditions, including changes to Work specified in other Sections. Obtain permission of Owner before proceeding.

1.7 CONTRACTORS' USE OF PREMISES

- A. Refer to Division 01.
- B. The Owner will be responsible for the identification and abatement of all hazardous materials and asbestos associated with the project. Although great care will be taken to eliminate any risks, the Contractor must be aware that hazardous materials may exist on site. Therefore, the Contractor shall immediately suspend work and notify the Owner if asbestos or other hazardous material is suspected in the work area of the project.

1.8 WORK SEQUENCE

- A. Install work over the cooling season to accommodate Owner's occupancy requirements during the construction period. Coordinate mechanical schedule with other trades and other operations.
- B. A final construction schedule to be submitted to the owner and Engineer prior to the start of work.

1.9 FUTURE WORK

- A. Refer to Division 01.

1.10 SUMMARY OF PROJECT

- A. Refer to Division 01.

1.11 ALLOWANCES

- A. Refer to Division 01.

1.12 UNIT PRICES

- A. Refer to Division 01.

1.13 ALTERNATES

- A. Refer to Division 01.

1.14 REFERENCE STANDARDS

- A. Refer to Division 01.

1.15 SUBMITTALS

- A. Refer to Division 01.

1.16 PROPOSED PRODUCTS LIST

- A. Refer to Division 01.

1.17 CONTRACTOR-PREPARED SHOP DRAWINGS

- A. Refer to Division 01.

1.18 PRODUCT DATA

- A. Refer to Division 01.

1.19 SAMPLES

- A. Refer to Division 01.

1.20 MANUFACTURER'S INSTRUCTIONS

- A. Refer to Division 01.

1.21 MANUFACTURER'S CERTIFICATES

- A. Refer to Division 01.

1.22 QUALITY CONTROL SERVICES

- A. Refer to Division 01.

1.23 MANUFACTURER'S FIELD SERVICES AND REPORTS

- A. Refer to Division 01.

1.24 CONTRACT CLOSEOUT

- A. Closeout Procedures
 - 1. Refer to Division 01.
- B. Final Cleaning
 - 1. Refer to Division 01.
- C. Adjusting
 - 1. Refer to Division 01.
- D. Project Record Documents
 - 1. Refer to Division 01.

1.25 O&M DATA

- A. Quality Assurance
 - 1. Refer to Division 01.

- B. Format
 - 1. Refer to Division 01.
- C. Contents, Each Volume
 - 1. Refer to Division 01.
- D. Manual for Materials and Finishes
 - 1. Refer to Division 01.
- E. Manual for Equipment and Systems
 - 1. Refer to Division 01.
- F. Instruction of Owner Personnel
 - 1. Refer to Division 01.
- G. Submittals
 - 1. Refer to Division 01.
- H. Warranties
 - 1. Refer to Division 01.

1.26 REGULATORY REQUIREMENTS

- A. Conform to International Mechanical Code with City of Evanston Amendments, State of Illinois Plumbing Code with City of Evanston Amendments and NFPA 13, latest editions.
- B. Obtain permits and request inspections from Evanston Building Department.
- C. Conform to requirements of all other governing agencies and authorities having jurisdiction.

PART 2 - PRODUCTS

2.1 MATERIAL AND EQUIPMENT

- A. Refer to Division 01.

2.2 STORAGE AND PROTECTION

- A. Refer to Division 01.

2.3 PRODUCT OPTIONS

- A. Refer to Division 01.

2.4 SUBSTITUTIONS

- A. Refer to Division 01.

PART 3 - EXECUTION

3.1 SCOPE

- A. Work included under Divisions 20, 21, 22, and 23 shall include all labor, services, materials and equipment and performance of all work required for installation of mechanical, plumbing, and fire suppression systems as shown on Drawings and as herein specified in following sections.

3.2 INTERPRETATION OF CONSTRUCTION DOCUMENTS

- A. Should there be discrepancy or a question of intent, refer matter to Engineer for decision before ordering any equipment or materials or before starting any related work.
- B. Drawings and Specifications are to be taken together. Work specified and not shown or work shown and not specified shall be performed or furnished as though mentioned in both Specifications and Drawings. If there is discrepancy between Drawings and Specifications as to quantity or quality to be provided, the greater quantity or better quality shall be provided.
- C. Minor items and accessories or devices reasonably inferable as necessary to complete and proper installation and operation of any system shall be provided by Contractor for such system whether or not specifically called for by Specifications or Drawings.
- D. Engineer may change location of any equipment 5' and any piping, ductwork, conduit, etc. 10' in any direction without extra charge, provided such changes are made before installation.
- E. Locations of items not definitely fixed by dimensions are approximate only and exact locations necessary to secure the best conditions and results shall be determined at the site and shall be subject to review and approval by Architect.
- F. Follow drawings in laying out work, check drawings of other trades to verify spaces in which work will be installed, and maintain maximum headroom and space conditions at all points.
 - 1. Where headroom or space conditions appear inadequate, notify Architect or Owner's field representative before proceeding with installation.
 - 2. Duct and pipe rerouting and duct size changes shall be made at no additional cost to the Owner.
- G. Furnish advance information on locations and sizes of frames, boxes, sleeves and openings needed for the work, and also furnish information and shop drawings necessary to permit installation of other work without delay.
- H. Where there is evidence that parts of the Work specified in Divisions 20, 21, 22, and 23 will interfere with other work, assist in working out space conditions to make satisfactory adjustments, revise and submit coordinated shop drawings.
- I. After review and without additional cost to the Owner, make minor modifications in the work as required by structural interferences, by interferences with work of other sections or for proper execution of the work.
- J. Work installed before coordinating with other work so as to cause interference with other work shall be changed and corrected without additional cost to the Owner.
- K. Drawings are diagrammatic in nature and are a graphic representation of requirements and shall be followed as closely as actual building construction will permit. All changes from the plans necessary to make the work conform to the building as constructed and to fit the work of other trades or to conform to rules of the Governmental Authorities having jurisdiction, NFPA, OSHA and the Owner's Insurance Underwriters, shall be made by the Contractor without extra cost to the Owner.
- L. The layout of the piping, ductwork, equipment, etc., as shown on the drawings shall be checked and exact locations shall be determined by the dimensions of the equipment approved and the Contractor shall obtain approval for the revised layout before the apparatus is installed. The Contractor shall field measure or consult existing record Architectural and Structural Drawings if available for all dimensions, locations of partitions, locations and sizes of structural supports, foundations, etc.

- M. Omission in the Drawings and/or Specifications of any items necessary for the proper completion or operation of the work outlined in this specification shall not relieve the Contractor from furnishing same without additional cost to the Owner.
- N. The Equipment Shop Drawings will be furnished to the Contractor before roughing in. Contractor shall not install any piping or ductwork for said equipment until he has received approved shop drawings for same.

3.3 PROJECT/SITE CONDITIONS

- A. Each Contractor shall visit the site prior to bid submission to determine all existing conditions that may affect his work and shall make appropriate allowances for such conditions in his bid. Failure to visit the site shall not be cause for a request for additional compensation later in the project during construction.
- B. Install Work in locations shown on Drawings, unless prevented by Project conditions.
- C. Prepare drawings showing proposed rearrangement of Work to meet Project conditions, including changes to Work specified in other Sections. Obtain permission of Owner/Engineer before proceeding.

3.4 ALTERATIONS IN PRESENT BUILDING AND SYSTEMS

- A. Contractor shall take particular note of the revisions and alterations to the existing systems, facilities and equipment due to the new construction as indicated on the Drawings and/or in Specification. Contractor shall remove, reroute or alter all services, ductwork, etc., as required or as indicated on the drawings.
 - 1. The Contractor shall maintain all services in the existing building. In case, where new service connections are to be made to existing services and service interruptions can in no way be avoided, the service interruptions shall be with the minimum of inconvenience to the Owner and the work shall be done at such time of any day, Saturday and Sunday included, and only as directed by the Owner or the Architect.

3.5 ERECTION & WORKMANSHIP

- A. Contractor is to be responsible for all work fitting into place in satisfactory, neat and workmanlike manner in every particular, to approval of Engineer.
- B. Unless explicitly stated to contrary, each Contractor shall furnish and install each item of equipment or material hereinafter specified, complete with all necessary fittings, supports, trim, piping, insulation, etc., as required for complete and operating installation.
- C. Equipment and materials shall be installed according to manufacturer's instruction unless otherwise specifically directed by Contract Documents.
- D. Contractor shall provide all necessary OSHA approved rigging, scaffolding, tools, tackle, labor, etc., necessary for the complete installation of the equipment.
- E. Contractor shall adapt his work to job conditions and make such changes as required and permitted by the Architect such as moving his work to clear beams, joints, light fixtures, etc., adjusting risers, etc. avoiding interferences with windows and openings, etc. raising or lowering his work to permit the passing of ductwork or the work of other trades, etc., all as required or as job conditions dictate, without any additional costs to the Owner.

- F. All appliances and equipment shall be installed and connected with best engineering practices and in accordance with the manufacturer's best instructions and recommendations.
- G. Work done by Contractor at the site in the execution of this Project shall be performed only by skilled mechanics, recognized as such in their respective trades in the direct employ either of the Contractor proper or of affiliate firms which have a longstanding and continuing formal agreement with the Contractor for providing the rendered services on similar work of this type.

3.6 PROTECTION FROM INJURY

- A. All pipes, fixtures, traps, equipment, and other parts of the Work shall be protected against injury by freezing or exposure to the weather during construction while stored or installed in place.

3.7 MECHANICAL AND ELECTRICAL WORK COORDINATION

- A. Refer to Division 01.

3.8 CUTTING AND PATCHING

- A. Refer to Division 01.

3.9 ACCESS PANELS

- A. Where control valves, shutoff valves, drip traps, heating coils, dampers, pull boxes or other specialties, which require service or adjustment, are installed above inaccessible type furred ceilings or within furred walls, Contractor whose equipment is involved shall furnish and install access panels as required.
- B. Access panels shall be of sufficient size to make possible servicing, adjustment, removal and replacement of concealed equipment through opening provided. Panels shall be sized as shown on drawings, or if sizes are not shown, shall be minimum of 16" x 24" in walls and 24" x 24" in ceilings.
- C. Contractor shall confer with other trades with respect to access panel locations and shall, wherever practical, group valves, traps, dampers, etc. in such way as to be accessible from single panel and eliminate as many access panels as possible.
- D. Submit shop drawings for review before ordering panels. Where fire rating is required, furnish label doors compatible with fire rating of assembly.

3.10 SOUND CONTROL

- A. Piping, ductwork, etc. shall pass through sleeves tightly packed with glass fiber or oakum and caulked on both sides with non-hardening acoustical sealant. Refer to Division 20 Section 20 0517, "Penetrations for Mechanical, Plumbing, and Fire Suppression."

3.11 FIRE RATED PENETRATIONS

- A. Sleeves for pipes and ducts through fire rated and fire resistive floors and walls shall be constructed of materials classified by UL to provide fire stopping equal to time rating of construction being penetrated. Use asbestos free materials that comply with applicable codes and have been tested under positive pressure in accordance with UL 1479 or ASTM E 814.
- B. Install penetration seal materials in accordance with printed instructions of the UL Fire Resistance Directory and in accordance with manufacturer's instruction.
- C. Seal holes or voids made be penetrations to ensure an effective smoke barrier.

- D. Where floor openings without penetrating items are more than 4" in width and subject to traffic or loading, install fire stopping materials capable of supporting same loading as floor.
- E. Protect materials from damage on surfaces subject to traffic.
- F. Examine penetration sealed areas to ensure proper installation before concealing or enclosing areas.
- G. Keep areas of work accessible until inspection by applicable code authorities.
- H. Perform under this section patching and repairing of fire stopping caused by cutting or penetration by other trades.
- I. Clean up spills of liquid components.
- J. Neatly cut and trim materials as required.
- K. Remove equipment, materials and debris, leaving area in undamaged, clean condition.

3.12 PROTECTION OF ELECTRICAL EQUIPMENT

- A. Contractor shall furnish and install sheet metal drain pans beneath piping that is routed above electrical equipment and/or above the 3' access space in front of such equipment. Electrical equipment, for the purpose of addressing drain pan requirements, shall be defined as free-standing or wall-mounted switchgear, transformers, distribution boards or motor control centers. Piping includes, but is not limited to, plumbing, fire suppression, mains (not branch piping with sprinkler heads), hydronic heating or cooling, steam and condensate, and fuel systems.
 - 1. Drain pans shall be 20 gauge galvanized sheet metal with a minimum 4" high turned up edge. Bottom of drain pan shall slope to a single drainage point at 1/8" per foot. A 1" diameter clear plastic tube shall allow collected fluid to drain to the nearest open site floor drain. Secure plastic tubing to building structure only.
 - 2. Drain pan shall be hung from building structure with angle iron trapeze hangers (no hanger shall penetrate the drain pan). Consider drain pan to be full of water for hanger load calculations.
 - 3. Drain pans shall include liquid detectors with alarms only if noted on the drawings.
- B. Provide sprinkler heads beneath drain pan only as required by NFPA.
- C. Contractor shall include provisions to adjust the local lighting layout, at no extra cost to Owner, in order to accommodate any detrimental effect the drain pan has on the illumination of the electrical equipment and access space.

3.13 STARTING OF SYSTEMS

- A. Refer to Division 01.

3.14 TESTING, ADJUSTING AND BALANCING

- A. Contractor shall appoint, employ and pay for services of independent firm to perform testing, adjusting and balancing.
- B. Independent firm will perform services specified in Division 01 Section 01 4000, "Quality Control Services" and Division 23 Section 23 0593, "Testing, Adjusting, and Balancing for HVAC," except for factory tests.

- C. Reports will be submitted by independent firm to Engineer indicating observations and results of tests and indicating compliance or non-compliance with specified requirements and with requirements of Contract Documents.

3.15 ALTERATION PROJECT PROCEDURES

- A. Refer to Division 01.

3.16 DEMONSTRATIONS AND INSTRUCTIONS TO OWNER PERSONNEL

- A. Refer to Division 01.

END OF SECTION

P:\22 Projects\22-1142-00coev\04 Design\07 Specs\Div 20\20 0500 Basic Requirements for M-P-FP.docx

**SECTION 20 0501
MINOR MECHANICAL, PLUMBING, AND FIRE SUPPRESSION DEMOLITION**

PART 1 - GENERAL

1.1 SECTION INCLUDES

- A. Minor demolition specifically applicable to Divisions 20, 21, 22, 23, 27, and 28.

PART 2 - PRODUCTS

2.1 MATERIALS AND EQUIPMENT

- A. Refer to Division 01.
- B. Materials and equipment for patching and extending work: As specified in individual Sections.

PART 3 - EXECUTION

3.1 EXAMINATION

- A. Verify field measurements, equipment location, piping and ductwork sizes and arrangements as shown on Drawings.
- B. Verify that abandoned piping, ductwork and equipment serve only abandoned facilities.

3.2 PREPARATION

- A. Disconnect mechanical systems in walls, floors and ceilings scheduled for removal.

3.3 DEMOLITION AND EXTENSION OF EXISTING SYSTEMS

- A. Demolish and extend existing work under provisions of Division 01 and this Section.
- B. In general, mechanical, plumbing, fire suppression, medical gas, and electrical remodeling work is shown on Drawings but carefully study all drawings for all contracts for "demolition" and "remodeling" work in existing building and field check to verify locations where such work is being done to determine exact extent of work required. No extra will be allowed for additional work required because of demolition or remodeling whether or not work is specifically noted, itemized or shown on Drawings.
- C. Remove existing equipment and materials pertaining to contract as specified or as required, whether shown on Drawings or not, to prepare for new work of all contracts.
- D. Where necessary, reroute piping, ducts, etc. from within walls, floors, ceilings, etc. being removed. Contractor involved with interrupted service shall be responsible for accomplishing required work whether shown on Drawings or not.
- E. Cap all abandoned or terminated piping, etc. below floor, behind wall surface, above ceiling, etc., as required to be completely concealed after new work is complete.
- F. Cap or plug all pipes, valves, fittings, etc. left open after demolition if they are not to be reused.
- G. Maintain access to existing mechanical installations which remain active. Modify installation or provide access panel as appropriate.
- H. Extend existing installations using materials and methods compatible with existing mechanical installations, or as specified.

3.4 DISPOSITION OF REMOVED EQUIPMENT

- A. Where existing materials or equipment are specified to be removed from service, respective Contractor shall take possession of same, coordinate with Owner where items are to be stored or remove unwanted items from site promptly, except as specified below or unless otherwise noted on Drawings.
- B. All salvageable material and equipment, including but not necessarily limited to plumbing fixtures, heating units, air conditioning units, piping, valves, etc., shall be removed and maintained in as good condition as possible and turned over to Owner. However, if Owner decides any such materials are of no value to him, then they shall become property of Contractor who shall remove such discarded work from premises and dispose of same.
- C. Existing equipment or systems, etc. which are specified to be replaced by new equipment, or system etc. shall not be removed from service until the new equipment, materials, systems, etc. have actually arrived at project site.

3.5 INSTALLATION

- A. Install relocated materials and equipment under the provisions of Division 01.

3.6 CLEANING AND REPAIR

- A. Refer to Division 01.
- B. Clean and repair existing materials and equipment which remain or are to be reused.

END OF SECTION

P:\22 Projects\22-1142-00coev\04 Design\07 Specs\Div 20\20 0501-Minor M-P-FP Demolition.docx

SECTION 20 0513
MOTOR REQUIREMENTS FOR MECHANICAL, PLUMBING, AND FIRE SUPPRESSION EQUIPMENT

PART 1 - GENERAL

1.1 SCOPE OF WORK

- A. Motor requirements specifically applicable to Divisions 20, 21, 22, and 23, including:
 - 1. Single-phase general-purpose, horizontal, small and medium, squirrel-cage induction motors for use on ac power systems up to 600 volts.
 - 2. Three-phase general-purpose, horizontal, small and medium, squirrel-cage induction motors for use on ac power systems up to 600 volts.
- B. Coordination
 - 1. Coordinate features of motors, installed units, and accessory devices to be compatible with the following such that all items furnished constitute a properly related package:
 - a. Motor starters
 - b. Motor controllers
 - c. Variable frequency drives
 - d. Torque, speed and horsepower requirements of the load
 - e. Ratings and characteristics of supply circuit and required control sequence
 - f. Ambient and environmental conditions of installation location
 - 2. Providing a motor to satisfy the efficiency requirements specified herein, is the responsibility of the Contractor. If any given manufacturer or supplier of the motorized equipment cannot provide a motor that satisfied the specified efficiency requirements, the Contractor is responsible for any and all steps necessary to provide an adequate motor including but not necessarily limited to:
 - a. Coordinating delivery and installation of an acceptable motor to the motorized equipment supplier for factory-installation.
 - b. Field-installation of an acceptable motor on the motorized equipment. Field installation shall not void the warranty of the motorized equipment.

1.2 DEFINITIONS

- A. Factory-installed motor: A motor installed by the motorized equipment manufacturer at the equipment manufacturer's factory as a component of the equipment.
- B. Field-installed motor: A motor installed on the motorized equipment at the Project site.

1.3 CODES AND STANDARDS (UTILIZE LATEST EDITION)

- A. ASHRAE 90: Energy Standard for Buildings except Low-Rise Residential Buildings
- B. AFBMA 9: Load Ratings and Fatigue Life for Ball Bearings
- C. ANSI/IEEE 112B: Test Procedure for Polyphase Induction Motors and Generators
- D. EISA: The Energy Independence and Security Act of 2007
- E. IECC: International Energy Conservation Code

- F. IEEE 112-2004: Standard Test Procedure for Polyphase Induction Motors and Generators
- G. IEEE 841-2001: Standard for Petroleum and Chemical Industry - Severe Duty Totally Enclosed Fan-Cooled (TEFC) Squirrel Cage Induction Motors - Up to and Including 370 kW (500 hp)
- H. NETA ATS: Acceptance Testing Specification
- I. NFPA 70: National Electrical Code
- J. NEMA MG : Motors and Generators
- K. UL 1004: Electric Motors

1.4 QUALITY ASSURANCE

- A. Manufacturer shall be a company specializing in manufacture of electric motors for the intended use and their accessories, with minimum three years documented product development, testing and manufacturing experience.
- B. All motors shall be UL 1004 listed.
- C. Motor efficiencies shall be based on the IEEE 112, Test Method B.

1.5 SUBMITTALS

- A. Preconstruction – Prior to construction provide the following in accordance with Division 01 and Specification 20 0500 – Basic Requirements for Mechanical, Plumbing, and Fire Suppression:
 - 1. Product Data
 - a. Submit manufacturer’s literature indicating:
 - (1) Type and size of motor
 - (2) Name plate data and rating
 - (3) Weight
 - (4) Conduit entry and ground lug locations
 - (5) Enclosure type and mounting arrangement
 - (6) Insulation class
 - (7) Information on coating or finishes
 - (8) Nominal minimum efficiency
 - (a) Provide statement that all motors 1 hp and larger meet “premium efficiency” requirements specified herein.
 - (9) Nominal minimum power factor
 - (10) Sound power levels in dba
 - b. Submit manufacturer’s test results verifying guaranteed minimum efficiency and power factor for all three phase motors larger than 1 hp.
 - c. Submit manufacturer’s literature for bearing protection grounding rings. If not integral to the motor supplied, but field installed as an option, also provide manufacturer’s installation instructions.
 - 2. Manufacturer’s installation and operating manuals.

B. Contract Closeout – At contract closeout provide the following in accordance with Division 01 and Specification 20 0500 – Basic Requirements for Mechanical, Plumbing, and Fire Suppression:

1. Operating and Maintenance Data including:
 - a. Product data
 - b. Installation instructions
 - c. Assembly drawings
 - d. Replacement parts list
 - e. Maintenance and operation instructions
2. Test Reports
 - a. Field installed motor test
 - b. Field installed bearing protection ring tests
3. Warranties

1.6 DELIVERY, STORAGE AND HANDLING

- A. Deliver products to site.
- B. Protect motors stored on-site from weather and moisture by maintaining factory covers and suitable weather-proof covering. For extended outdoor storage, remove motors from equipment and store separately.

1.7 SPARE PARTS

Not Applicable

PART 2 - PRODUCTS

2.1 MOTORS

- A. Acceptable Manufacturers
 1. Baldor Electric
 2. Emerson Motors
 3. GE Motors
 4. Leeson (Lincoln)
 5. Marathon Electric
 6. Siemens
 7. TECO – Westinghouse
- B. General Motor Requirements Applicable to All Motors
 1. Comply with the requirements in this section except when stricter requirements are specified on the drawings or Division 23 Equipment Sections.
 2. Comply with NEMA MG 1.
 3. Motor Size:
 - a. Motors shall be capable of driving the intended load and not exceeding the design horsepower.

- b. Motors shall be selected such that the brake horsepower (bhp), including drive losses of the driven equipment, does not exceed 90% of the motor nameplate rating at design conditions.
 - 4. Visible Nameplate:
 - a. Provide a visible motor nameplate indicating motor horsepower, voltage, phase, cycles, RPM, full load amps, locked rotor amps, frame size, manufacturer's name and model number, and service factor.
 - b. Nameplates for all three-phase motors shall also indicate power factor and efficiency.
 - c. Nameplate shall indicate "Premium Efficiency" where such a motor is provided.
 - 5. Motor Characteristics:
 - a. Duty Rating:
 - (1) Continuous duty at ambient temperature of 104°F (40°C) and at altitude of 3,300 feet above sea level.
 - (2) Motors shall be capable of not less than six (6) starts in a twenty-four (24) hour period.
 - b. Capacity and Torque Characteristics:
 - (1) Sufficient to start, accelerate and operate connected loads at designated speeds, at installed altitude and environment, with indicated operating sequence, and without exceeding nameplate ratings or service factor.
 - 6. Enclosures:
 - a. Enclosure Material:
 - (1) Cast iron for motor frame 25 hp and larger.
 - (2) Rolled steel for motor frame sizes smaller than 25 hp.
 - b. Open drip proof (ODP) for indoor locations not in an airstream.
 - c. Totally enclosed fan cooled (TEFC) for all motors located within an airstream including within air handling unit housings, ducted airstreams, and ceiling or floor air plenums.
 - (1) Totally enclosed air over (TEAO) motors are acceptable for air handling units with fan arrays provided they meet the efficiency requirements of the TEFC motors.
 - d. Motors located in exterior locations shall be TEFC with weatherproof cover.
 - (1) Totally enclosed air over (TEAO) motors are acceptable for cooling tower applications provided they meet the efficiency requirements of the TEFC motors.
- C. Three Phase Motors
 - 1. Efficiency:
 - a. Motor efficiencies shall at a minimum comply with the most recent editions of the International Energy Conservation Code and ASHRAE Standard 90.1.
 - b. All general purpose, three-phase motors from 1 hp up to 200 hp driving Division 21-, 22-, and/or 23-specified equipment (e.g. stand-alone fans, fans within air handling units, heating hot water pumps, chilled water pumps, domestic water pumps) except those

motors defined in Paragraph [C] below shall be premium efficiency and meet the minimum efficiencies specified in the following table:

HP	TOTALLY ENCLOSED, FAN COOLED MOTORS			OPEN, DRIP-PROOF MOTORS		
	1200 rpm	1800 rpm	3600 rpm	1200 rpm	1800 rpm	3600 rpm
1	82.5	85.5	77.0	82.5	85.5	77.0
1.5	87.5	86.5	84.0	86.5	86.5	84.0
2	88.5	86.5	85.5	87.5	86.5	85.5
3	89.5	89.5	86.5	88.5	89.5	85.5
5	89.5	89.5	88.5	89.5	89.5	86.5
7.5	91.0	91.7	89.5	90.2	91.0	88.5
10	91.0	91.7	90.2	91.7	91.7	89.5
15	91.7	92.4	91.0	91.7	93.0	90.2
20	91.7	93.0	91.0	92.4	93.0	91.0
25	93.0	93.6	91.7	93.0	93.6	91.7
30	93.0	93.6	91.7	93.6	94.1	91.7
40	94.1	94.1	92.4	94.1	94.1	92.4
50	94.1	94.5	93.0	94.1	94.5	93.0
60	94.5	95.0	93.6	94.5	95.0	93.6
75	94.5	95.4	93.6	94.5	95.0	93.6
100	95.0	95.4	94.1	95.0	95.4	93.6
125	95.0	95.4	95.0	95.0	95.4	94.1
150	95.8	95.8	95.0	95.4	95.8	94.1
200	95.8	96.2	95.4	95.4	95.8	95.0

- c. The following motor types and sizes driving Division 21, 22, and/or 23 specified equipment shall meet the minimum efficiencies defined in the table below:
- (1) Fire pump motors
 - (2) General purpose motors greater than 200 hp up to 500 hp
 - (3) U-frame motors
 - (4) Design C motors
 - (5) Motors for close-coupled pumps
 - (6) Footless motors
 - (7) Vertical solid shaft normal thrust motors
 - (8) 8-pole motors (900 rpm)
 - (9) Three-phase motors smaller than 600 volts and operating at voltages other than 230 or 460 volts

HP	TOTALLY ENCLOSED, FAN COOLED MOTORS			OPEN, DRIP-PROOF MOTORS		
	1200 rpm	1800 rpm	3600 rpm	1200 rpm	1800 rpm	3600 rpm
1	80	82.5	75.5	80	82.5	NR
1.5	85.5	84	82.5	84	84	82.5
2	86.5	84	84	85.5	84	84
3	87.5	87.5	85.5	86.5	86.5	84
5	87.5	87.5	87.5	87.5	87.5	85.5
7.5	89.5	89.5	88.5	88.5	88.5	87.5
10	89.5	89.5	89.5	90.2	89.5	88.5
15	90.2	91	90.2	90.2	91	89.5
20	90.2	91	90.2	91	91	90.2
25	91.7	92.4	91	91.7	91.7	91
30	91.7	92.4	91	92.4	92.4	91
40	93	93	91.7	93	93	91.7
50	93	93	92.4	93	93	92.4
60	93.6	93.6	93	93.6	93.6	93
75	93.6	94.1	93	93.6	94.1	93
100	94.1	94.5	93.6	94.1	94.1	93
125	94.1	94.5	94.5	94.1	94.5	93.6
150	95	95	94.5	94.5	95	93.6
200	95	95	95	94.5	95	94.5
250	95	95	95.4	95.4	95.4	94.5
300	95	95.4	95.4	95.4	95.4	95
350	95	95.4	95.4	95.4	95.4	95
400	NR	95.4	95.4	NR	95.4	95.4
450	NR	95.4	95.4	NR	95.8	95.8
500	NR	95.8	95.4	NR	95.8	95.8

2. Service Factor

a. Per the following NEMA Service Factor Table

HP	900 RPM	1200 RPM	1800 RPM	3600 RPM
$\frac{1}{6}$ to $\frac{1}{3}$	1.35	1.35	1.35	1.35
$\frac{1}{2}$	1.15	1.25	1.25	1.25
$\frac{3}{4}$	1.15	1.15	1.25	1.25
1	1.15	1.15	1.15	1.25
1½ to 150	1.15	1.15	1.15	1.15

b. Do not take advantage of service factors in selection of motors.

3. Rotor: Random-wound, squirrel cage.

4. Bearings:
 - a. Grease lubricated anti friction ball bearings with housings equipped with plugged provision for re-lubrication, rated for minimum AFBMA 9, L 10 life of 150,000 hours for direct-coupled applications and 50,000 hours for belted applications. Calculate bearing load with NEMA minimum V belt pulley with belt center line at end of NEMA standard shaft extension. Stamp bearing sizes on nameplate.
 - b. Motors not installed in horizontal position shall be provided with suitable bearings.
 - c. Grease fittings shall be provided. Both fittings and drain plugs shall be fully accessible while the motor is in operation. Where motors are installed in an inaccessible location, the grease fitting shall be extended to an accessible location. High pressure hydraulic steel tubing and fittings shall be used.
 5. Temperature Rise and Insulation:
 - a. Motors smaller than 1 hp: NEMA Class B temperature rise with Class B insulation.
 - b. Motors 1 hp and larger: NEMA Class B temperature rise with Class F insulation.
 6. Starting Code Designation:
 - a. Motors smaller than 15 hp: Manufacturer's standard starting characteristics.
 - b. Motors 15 hp and larger: NEMA starting Code F or Code G.
 7. Motor windings shall be first grade copper.
- D. Additional Requirements for Three Phase Motors Used with Variable Frequency Drives
1. Motor shall be "inverter-ready" by complying with or exceeding the NEMA MG1 Part 31 requirements regarding special purpose motors for use with variable frequency drives.
 2. Windings shall be copper magnet wire with moisture-resistant insulation, varnish, designed and tested to resist transient spikes, high frequencies, and short time rise pulses, produced by pulse-width modulated inverters.
 3. Motors shall be equipped with shaft grounding ring(s) to dissipate potential VFD-induced motor shaft currents by grounding through the motor housing.
 - a. Provide one (1) grounding ring per motor.
 - b. Provide solid ring or split ring, based on grounding ring manufacturer's recommendations.
 - c. Shaft grounding brushes or insulated bearings are not acceptable.
 - d. Shaft Grounding Rings shall be factory-installed or field-installed by the motor manufacturer or field-installed by the contractor.
 - e. Acceptable Product: Aegis SGR Bearing Protection Ring as manufactured by Electric Static Technology.
 - f. This provision for grounding devices shall not apply to motors used in environments defined as Class 1 Division 1, Division 2, or Class 1 Zone 1, Zone 2 hazardous locations.
- E. Additional Requirements for Motor Driven Equipment Located Outdoors
1. Epoxy seal windings using vacuum and pressure with rotor and stator surfaces protected with epoxy enamel.
 2. Bearings shall be double shielded with waterproof non-washing grease.
 3. Provide weatherproof enclosure for motor.

- F. Additional Requirements for Motors 100 hp and Larger
 - 1. Provide with Thermistor System: Three PTC thermistors imbedded in motor windings and epoxy encapsulated solid state control relay for wiring into motor starter; refer to Electrical Specifications.
- G. Single Phase Motor
 - 1. Motors larger than 1/20 hp shall be one of the following, to suit starting torque and requirements of specific motor application:
 - a. Permanent-split capacitor
 - b. Split phase
 - c. Capacitor start, inductor run
 - d. Capacitor start, capacitor run
 - 2. Multispeed Motors: Variable-torque, permanent-split-capacitor type.
 - 3. Bearings: Pre-lubricated, antifriction ball bearings or sleeve bearings suitable for radial and thrust loading.
 - 4. Motors 1/20 hp and Smaller: Shaded-pole type.
 - 5. Thermal Protection: Internal protection to automatically open power supply circuit to motor when winding temperature exceeds a safe value calibrated to temperature rating of motor insulation. Thermal protection device shall automatically reset when motor temperature returns to normal range.
 - 6. For fractional horsepower motors where connection is made directly, provide conduit connection in end frame.

PART 3 - EXECUTION

3.1 APPLICATION

- A. Electrical Service
 - 1. Motors $\frac{3}{4}$ hp and larger shall operate on 480 or 208 volt, three-phase 60 Hertz, alternating current, except as otherwise noted.
 - 2. Motors smaller than $\frac{3}{4}$ hp shall operate on 120 volt, single-phase, 60 Hertz, alternating current, except as otherwise noted.
- B. Motor speed shall not exceed 1,750 rpm unless otherwise specified.

3.2 INSTALLATION

- A. Factory Installed Motors
 - 1. Not used
- B. Field Installed Motors
 - 1. Examine area to receive field installation for compliance with required tolerances and other conditions affecting performance. Examine roughing-in of conduit systems to verify actual locations. Correct any deficiencies found during examination.
 - 2. Anchor motor assembly to base, adjustable rails or other support according to manufacturers' instructions. Level and align.

3. Clean motors according to manufacturers' written instructions.
- C. Field Installed Bearing Protection Rings
1. Verify applicable maximum and minimum temperature and humidity allowances with manufacturer's technical support.
 2. Based on motor application, motor size, motor frame, and bearing types, use shaft grounding ring kit that corresponds to shaft grounding ring manufacturer's installation recommendations and instructions.
 3. Based on manufacturer's installation instructions, clean the motor shaft and other motor surfaces to remove any coatings, paint or other nonconductive material to prepare all conducting surfaces.
 4. Apply conductive shaft surface coating per manufacturer's recommendations and installation instructions.
 5. As required by the installation and per manufacturer's recommendations and installation instructions:
 - a. Drill and tap installation holes in the motor end bracket per manufacturer's installation instructions.
 - b. Apply manufacturer supplied adhesive and hold in place until the adhesive sets.

3.3 TESTING

- A. Field installed motor test
1. Run each motor. Demonstrate correct rotation, alignment and speed.
 2. Test interlocks and control features for proper operation.
 3. Verify that current in each phase is within nameplate rating.
 4. NETA Acceptance Test
 - a. Perform an acceptance test in accordance with NETA Acceptance Testing Specification, Section 7.15.1.
 - b. Correct any deficiencies found by test and repeat acceptance test.
 5. Provide test result report within two weeks of testing indicating that each of the above tests was completed and the results of those tests.
- B. Field installed bearing protection ring tests
1. Pre-installation test:
 - a. Place the positive and negative meter leads on the shaft at a place where the grounding ring fibers will contact the shaft and read the resistance.
 - b. If the reading is higher than 2 ohms provide additional cleaning and retest.
 - c. Provide test result report within two weeks of testing indicating the resistance of each motor.
 2. Post-installation test:
 - a. Place one meter lead on the grounding ring and the other on the motor frame and read the resistance. NOTE: Motor must be grounded to common earth ground with drive according to application standards.

- b. Provide test result report within two weeks of testing indicating the resistance of each motor.

END OF SECTION

P:\22 Projects\P22-1142-00coev\04 Design\07 Specs\Div 20\20 0513-Motor Requirements for M-P-FP.docx

SECTION 20 0516
EXPANSION COMPENSATION FOR MECHANICAL, PLUMBING, AND FIRE SUPPRESSION

PART 1 - GENERAL

1.1 SCOPE OF WORK

- A. Expansion compensation specifically applicable to Divisions 20, 21, 22, and 23, including:
 - 1. Flexible ball joints
 - 2. Slip joints
 - 3. Metal packless expansion compensator
 - 4. Metal bellows packless expansion joint
 - 5. Flexible hose packless expansion joint
 - 6. Alignment guides
 - 7. Anchors

1.2 CODES AND STANDARDS (USE LATEST EDITION)

- A. American Water Works Association
 - 1. AWWA C606: Grooved and Shouldered Joints
- B. American Welding Society (AWS)
 - 1. AWS D1.1: Structural Welding Code - Steel
- C. ASME International
 - 1. ASME B18.10: Track Bolts and Nuts
 - 2. ASME B31.9: Building Services Piping
- D. ASTM International
 - 1. ASTM A 36: Specification for Carbon Structural Steel
 - 2. ASTM A 53: Specification for Pipe, Steel, Black and Hot-Dipped, Zinc-Coated, Welded and Seamless
 - 3. ASTM A 183: Specification for Carbon Steel Track Bolts and Nuts
 - 4. ASTM A 307: Specification for Carbon Steel Bolts and Studs, 60 000 PSI Tensile Strength
 - 5. ASTM C 881: Specification for Epoxy-Resin-Base Bonding Systems for Concrete
 - 6. ASTM F 8444: Specification for Washers, Steel, Plain (Flat), Unhardened for General Use
 - 7. ASTM F 1007: Specification for Pipe-Line Expansion Joints of the Packed Slip Type for Marine Applications
 - 8. ASTM F 1120: Specification for Circular Metallic Bellows Type Expansion Joints for Piping Applications
 - 9. ASTM F 1123: Specification for Non-Metallic Expansion Joints

- E. Expansion Joint Manufacturers Association, Inc. (EJMA)
 - 1. EJMA: Standards of the Expansion Joint Manufacturers Association

1.3 QUALITY ASSURANCE

- A. Design Criteria:
 - 1. Heating Water: 50°F installation temperature, 210°F operating temperature.
 - 2. Steam and Condensate: 50°F installation temperature, 330°F operating temperature.
 - 3. Domestic Hot Water: 50°F installation temperature, 140°F operating temperature.
 - 4. Chilled Water: 110°F installation temperature, 40°F operating temperature.
 - 5. Domestic Cold Water: 110°F installation temperature, 40°F operating temperature.
 - 6. All thermal expansion calculations shall include at 30% safety factor.
- B. Expansion compensator elements shall be as specified herein and shall be selected by the manufacturer to withstand system pressure and temperature conditions and to absorb thermal expansion of the piping of minimum 1¼" per 100 feet of pipe.

1.4 SUBMITTALS

- A. Preconstruction – Prior to construction provide the following in accordance with Division 01 and Specification 20 0500 – Basic Requirements for Mechanical, Plumbing, and Fire Suppression:
 - 1. Product Data: Submit product data on all expansion compensation devices. Product data to include, but not limited to materials, finishes, approvals, extension/compression ratings, and dimensional information.
 - 2. Design Calculations: For each anchor and alignment guide, including analysis data, signed and sealed by the qualified professional engineer responsible for their preparation.
 - a. Design Calculations: Calculate requirements for thermal expansion of piping systems and for selecting and designing expansion joints, loops, and swing connections.
 - b. Anchor Details: Detail fabrication of each anchor indicated. Show dimensions and methods of assembly and attachment to building structure.
 - c. Alignment Guide Details: Detail field assembly and attachment to building structure.
 - d. Schedule: Indicate type, manufacturer's number, size, material, pressure rating, end connections, and location for each expansion joint.
 - 3. Manufacturer's installation and operating manuals.
- B. Contract Closeout – At contract closeout provide the following in accordance with Division 01 and Specification 20 0500 – Basic Requirements for Mechanical, Plumbing, and Fire Suppression:
 - 1. Operating and Maintenance Data including:
 - a. Product data
 - b. Installation instructions
 - c. Assembly drawings
 - d. Replacement parts list
 - e. Maintenance and operation instructions

2. Test Reports
 - a. Manufacturer installation certification
3. Warranties

1.5 DELIVERY, STORAGE AND HANDLING

- A. Accept materials on site in original factory packaging, labeled with manufacturer's identification.
- B. Protect from weather and construction traffic, dirt, water, chemical, and damage, by storing in original packaging.

1.6 SPARE PARTS

Not Applicable

1.7 WARRANTY

- A. One year warranty on products and complete installation commencing at the time of Substantial Completion.

PART 2 - PRODUCTS

2.1 FLEXIBLE HOSE PACKLESS EXPANSION JOINT

- A. Acceptable Manufacturers:
 1. Flexicraft
 2. Mason
 3. Metraflex
- B. Prefabricated expansion compensator loops with two braided hoses joined by a 60° v-style fitting and 120° return elbows or by a 180° long radius return bend with 90° return elbows.
- C. Hoses shall be Type 304 stainless steel corrugated hose with Type 304 stainless steel braid or bronze corrugated hose with bronze braid.
- D. Expansion Joints for Copper Tubing 2" and Smaller: Copper-alloy fittings with solder-joint end connections, bronze hoses and single-braid bronze sheaths with 450 psig at 70°F and 340 psig at 450°F ratings.
- E. Expansion Joints for Copper Tubing 2-1/2" to 4": Copper-alloy fittings with threaded end connections, stainless-steel hoses and single-braid, stainless-steel sheaths with 300 psig at 70°F and 225 psig at 450°F ratings.
- F. Expansion Joints for Steel Piping 2" and Smaller: Carbon-steel fittings with threaded end connections, stainless-steel hoses and single-braid, stainless-steel sheaths with 450 psig at 70°F and 325 psig at 600°F ratings.
- G. Expansion Joints for Steel Piping 2-1/2" to 6": Carbon-steel fittings with flanged or weld end connections, stainless-steel hoses and double-braid, stainless-steel sheaths with 275 psig at 70°F and 200 psig at 600°F ratings.
- H. Expansion Joints for Steel Piping 8" to 12": Carbon-steel fittings with flanged or weld end connections, stainless-steel hoses and double-braid, stainless-steel sheaths with 165 psig at 70°F and 120 psig at 600°F ratings.

- I. Expansion Joints for Steel Piping 14" and Larger: Carbon-steel fittings with flanged or weld end connections, stainless-steel hoses double-braid, stainless-steel sheaths with 165 psig at 70°F and 120 psig at 600°F ratings.

2.2 ALIGNMENT GUIDES

- A. Acceptable Manufacturers
 1. Flex-Weld/Keflex
 2. Hyspan
 3. Metraflex
- B. Description: Steel, factory-fabricated alignment guide, with bolted two-section outer cylinder and base for attaching to structure; with two-section guiding spider for bolting to pipe.

2.3 ANCHORS

- A. Materials
 1. Steel Shapes and Plates: ASTM A36/A 36M.
 2. Bolts and Nuts: ASME B18.10 or ASTM A183, steel hex head.
 3. Washers: ASTM F 844, steel, plain, flat washers.
 4. Mechanical Fasteners: Insert-wedge-type stud with expansion plug anchor for use in hardened portland cement concrete, with tension and shear capacities appropriate for application.
 - a. Stud: Threaded, zinc-coated carbon steel.
 - b. Expansion Plug: Zinc-coated steel.
 - c. Washer and Nut: Zinc-coated steel.
 5. Chemical Fasteners: Insert-type-stud, bonding-system anchor for use with hardened Portland cement concrete, with tension and shear capacities appropriate for application.
 - a. Bonding Material: ASTM C 881/C 881M, Type IV, Grade 3, two-component epoxy resin suitable for surface temperature of hardened concrete where fastener is to be installed.
 - b. Stud: ASTM A 307, zinc-coated carbon steel with continuous thread on stud unless otherwise indicated.
 - c. Washer and Nut: Zinc-coated steel.

PART 3 - EXECUTION

3.1 INSPECTION

- A. Examine piping layout and notify Architect/Engineer of additional anchors or expansion joints required to adequately protect system.
- B. Make proper provision for expansion and contraction in all parts of piping systems (steam and condensate, all pressures, heating and domestic hot water) wherever possible by means of pipe bends, pipe offsets, swing connections or changes in direction of piping. Where piping network cannot be employed to absorb expansion and contraction in the piping systems, provide expansion joint compensators.

3.2 EXPANSION JOINT INSTALLATION

- A. Use of expansion compensators in non-accessible locations shall not be permitted.
- B. Accomplish structural work and provide equipment required to control expansion and contraction of piping, loops, pipe offsets and swing joints and provide corrugated bellows type expansion joints where required.
- C. Rigidly anchor pipe to building structure where necessary. Provide pipe guides so that movement takes place along axis of pipe only.
- D. Install packed-type expansion joints with packing suitable for fluid service.
- E. Install metal expansion compensators and joints according to EJMA's "Standards of the Expansion Joint Manufacturers Association, Inc."
- F. Compensators shall be suitable for pressures and temperatures indicated under pipe specifications.
- G. Pipe guides shall be of spider and sleeve type to insure multi-planar guiding and to allow complete insulation of the piping to be covered inside and outside with protective coating. Top half shall be removable. Guides shall be installed in accordance with EJMA's "Standards of the Expansion Compensators Manufacturers Association," latest edition.
- H. Securely anchor all mains and risers having expansion offsets or compensators to the building construction in such a manner as to throw all expansion towards the offsets or joints. All anchors shall be constructed of heavy steel and connected to the building construction. Anchors shall be furnished with turnbuckles or other suitable means for adjustment. Provide any additional structural members that may be required for proper installation of hangers, anchors, guides and supports. The method of securing the anchors to the building construction must be approved by the Architect/Engineer prior to installation.

3.3 ALIGNMENT GUIDE AND ANCHOR INSTALLATION

- A. Install alignment guides to guide expansion and to avoid end-loading and torsional stress.
- B. Install guide on each side of pipe expansion fittings and loops. Install guides nearest to expansion joint not more than four pipe diameters from expansion joint.
- C. Attach guides to pipe and secure guides to building structure.
- D. Install anchors at locations to prevent stresses from exceeding those permitted by ASME B31.9 and to prevent transfer of loading and stresses to connected equipment.
- E. Anchor Attachments:
 - 1. Anchor Attachment to Steel Pipe: Attach by welding. Comply with ASME B31.9 and ASME Boiler and Pressure Vessel Code: Section IX, "Welding and Brazing Qualifications."
 - 2. Anchor Attachment to Copper Tubing: Attach with pipe hangers. Use MSS SP-69, Type 24, U-bolts bolted to anchor.
- F. Fabricate and install steel anchors by welding steel shapes, plates, and bars. Comply with ASME B31.9 and AWS D1.1/D1.1M.
 - 1. Anchor Attachment to Steel Structural Members: Attach by welding.
 - 2. Anchor Attachment to Concrete Structural Members: Attach by fasteners. Follow fastener manufacturer's written instructions.
- G. Use grout to form flat bearing surfaces for guides and anchors attached to concrete.

3.4 TESTING

- A. Provide inspection services by the expansion compensation manufacturer's representative for the final installation.
- B. Provide a report by manufacturer's representative indicating installation errors or faults in the system that will impact performance. The report shall indicate whether the expansion compensation equipment has been properly installed or, if it requires correcting, the steps needed to properly complete the work. The final report shall certify that the deficiency listed have been corrected, the equipment has been properly installed and performing satisfactorily.

END OF SECTION

P:\22 Projects\142-00coev\04 Design\07 Specs\Div 20\20 0516-Expansion Compensation for M-P-FP.docx

SECTION 20 0517
PENETRATIONS FOR MECHANICAL, PLUMBING, AND FIRE SUPPRESSION SYSTEMS

PART 1 - GENERAL

1.1 SCOPE OF WORK

- A. Sleeve and sleeve seal for penetration through walls, floors, and roofs, specifically applicable to Divisions 20, 21, 22, and 23 including:
 - 1. Pipe sleeves and sleeve seals for pipe penetrations
 - 2. Duct sleeves for duct penetrations
 - 3. Firestopping
 - 4. Flashing

1.2 DEFINITIONS

- A. Firestopping (Through-Penetration Protection System): Sealing or stuffing material or assembly placed in spaces between, and penetrations through building materials to arrest movement of fire, smoke, heat, and hot gases through fire rated construction.

1.3 CODES AND STANDARDS

- A. American Society of Mechanical Engineers (ASME):
 - 1. ASME B31.1: Power Piping
 - 2. ASME B31.9: Building Service Piping Code
 - 3. ASME B36.10: Welded and Seamless Wrought Steel Pipe
- B. American Society for Testing and Materials (ASTM):
 - 1. ASTM A53: Specification for Pipe, Steel, Black and Hot-Dipped, Zinc-Coated Welded and Seamless
- C. National Fire Protection Association (NFPA):
 - 1. NFPA 13: Installation of Sprinkler Systems
 - 2. NFPA 14: Installation of Standpipe and Hose Systems
- D. Underwriters Laboratories Inc. (UL):
 - 1. UL 203: Pipe Hanger Equipment for Fire Protection Service
 - 2. UL 1479: Fire Tests of Through-Penetration Firestops

1.4 SUBMITTALS

- A. Preconstruction – Prior to construction provide the following in accordance with Division 01 and Specification 20 0500 – Basic Requirements for Mechanical, Plumbing, and Fire Suppression:
 - 1. Product Data: Submit product data on all sleeves and fire stopping materials including:
 - a. Materials
 - b. Finishes
 - c. Approvals

- d. Dimensional information
- B. Contract Closeout – At contract closeout provide the following in accordance with Division 01 and Specification 20 0500 – Basic Requirements for Mechanical, Plumbing, and Fire Suppression:
 - 1. Operating and Maintenance Data including:
 - a. Product data
 - b. Installation instructions
 - c. Assembly drawings
 - d. Replacement parts list
 - e. Maintenance and operation instructions
 - 2. Warranties

1.5 DELIVERY, STORAGE AND HANDLING

- A. Accept materials on site in original factory packaging, labeled with manufacturer's identification.
- B. Protect from weather and construction traffic, dirt, water, chemical, and damage, by storing in original packaging.

1.6 SPARE PARTS

Not Applicable

1.7 WARRANTY

- A. One year warranty on products and complete installation commencing at the time of Substantial Completion.

PART 2 - PRODUCTS

2.1 PIPE SLEEVES AND SLEEVE SEALS FOR PIPE PENETRATIONS

- A. Non-Fire Rated Walls
 - 1. Schedule 40 standard weight steel pipe or 18 gauge galvanized sheet steel sleeve
 - 2. Size sleeves large enough to allow for movement due to expansion and contraction. Provide for continuous insulation wrapping.
- B. Non-Fire Rated Floor
 - 1. Schedule 40 standard weight steel pipe sleeve
 - 2. Size sleeves large enough to allow for movement due to expansion and contraction. Provide for continuous insulation wrapping.
- C. Non-Fire Rated Wet Floor
 - 1. Schedule 40 galvanized steel pipe sleeve
 - 2. Size sleeves large enough to allow for movement due to expansion and contraction. Provide for continuous insulation wrapping.
- D. Fire Rated Walls
 - 1. Provide an approved penetration firestop system installed as tested in accordance with UL 1479 with an F rating of not less than the required rating of the wall penetrated.

- E. Fire Rated Floors
 - 1. Provide an approved penetration firestop system installed as tested in accordance with UL 1479 with an F rating and T rating of not less than the required rating of the floor penetrated.
- F. Smoke Rated Walls and Floors
 - 1. Provide an approved firestop penetration system installed as tested in accordance with UL 1479 with an L rating of not more than 5 cfm/ft² at both ambient and elevated temperature.
- G. Foundation Walls and Below Grade Walls
 - 1. Walls
 - a. Sleeve: Heavy wall welded or seamless steel pipe with 2" steel water stop. Model WS steel sleeve by Garlock Pipeline Technologies.
 - b. Sleeve seal: Modular, mechanical seal consisting of rubber links shaped to continuously fill the annular space between the pipe and the wall opening. Pressure plates shall be of molded glass reinforced nylon. Hardware shall be mild steel with a 60,000 psi minimum tensile strength and zinc dichromate coating. Links shall be loosely assembled with bolts to form a continuous rubber belt around the pipe with a pressure plate under each bolt head and nut. After the seal assembly is positioned in the sleeve or opening, tightening of the bolts shall cause the rubber sealing elements to expand and provide an absolutely water-tight seal between the pipe and wall opening. The seal shall be constructed so as to provide electrical insulation between the pipe and wall, thus reducing changes of cathodic reaction between these two members. Model C Link-Seal modular seal by Garlock Pipeline Technologies.
- H. Roof
 - 1. Plumbing vent stack sleeve fitting: Vent stack flashing sleeve; lacquered, coated cast iron body with adjustable combination membrane flashing flange and clamp. Basis of Design: Zurn Model Z-195-10.
 - 2. All other penetrations: Provide and install a pipe penetration roof curb as specified in Division 20 Section 20 0529, "Hangers and Supports for Mechanical, Plumbing and Fire Suppression Systems."

2.2 DUCT SLEEVES FOR DUCT PENETRATIONS

- A. Non-Fire Rated Walls
 - 1. Field formed 18 gauge galvanized steel sleeve.
 - 2. Size sleeves large enough to provide for continuous insulation wrapping.
- B. Non-Fire Rated Floors and Wet Floors
 - 1. Field formed 18 gauge galvanized steel sleeve.
 - 2. Size sleeves large enough to provide for continuous insulation wrapping.
- C. Fire Rated Walls Not Requiring a Fire Damper
 - 1. Provide an approved penetration firestop system installed as tested in accordance with UL 1479 with an F rating of not less than the required rating of the wall or floor penetrated.

- D. Fire Rated Walls Requiring a Fire Damper
 - 1. Provide and install the fire damper as required by UL and the manufacturer. Refer Division 20 Section "Ductwork Accessories."
- E. Smoke Rated Walls
 - 1. Provide and install the smoke damper as required by UL and the manufacturer. Refer to Division 20 Section "Ductwork Accessories."
- F. Roof – Provide and install a duct penetration roof curb as specified in Division 20 Section "Hangers and Supports."

2.3 FIRE STOPPING

- A. Approved Manufacturers
 - 1. Hilti
 - 2. 3M
- B. Provide firestopping products that are compatible with one another, with the substrates forming openings, and with the items penetrating through-penetration firestop systems, under conditions of service and application, as demonstrated by firestopping products manufacturer based on testing and field experience.
- C. Provide components for each firestopping system that are needed to install fill materials. Use only components specified by the firestopping manufacturer and approved by the qualified testing agency for the designated fire-resistance-rated systems.
- D. Use only firestopping products that have been tested for specific fire-resistance-rated construction conditions conforming to construction assembly type, penetrating item type or joint opening width and movement capabilities, annular space requirements, and fire-rating involved for each separate instance.
- E. Performance Requirements
 - 1. Provide products that upon curing, do not re-emulsify, dissolve, leach, breakdown, or otherwise deteriorate over time from exposure to atmospheric moisture, sweating pipes, ponding water or other forms of moisture characteristic during and after construction.
 - 2. Provide firestop sealants sufficiently flexible to accommodate motion such as pipe vibration, water hammer, thermal expansion and other normal building movement without damage to the seal.
 - 3. Pipe and duct insulation shall not be removed, cut away or otherwise interrupted through wall or floor openings. Provide products appropriately tested for the thickness and type of insulation utilized.
 - 4. Penetrants passing through fire-resistance rated floor-ceiling assemblies contained within chase wall assemblies shall be protected with products tested by being fully exposed to the fire outside of the chase wall. Systems within the UL Fire Resistance Directory that meet this criterion are identified with the words "Chase Wall Optional".
 - 5. Provide through-penetration firestop systems subjected to an air leakage test conducted in accordance with the Standards, ANSI/UL1479 for penetration and ANSI/UL2079 for joint systems, with published L-Ratings for ambient and elevated temperatures as evidence of the ability of the firestop system to restrict the movement of smoke.

6. Provide T-Rating Collar Devices tested in accordance with ASTM E-814 or ANSI/UL1479 for metallic pipe penetrations requiring T-Ratings per the applicable building code.

F. Materials

1. Firestopping Sealants: Provide only products having lower volatile organic compound (VOC) content than required by South Coast Air Quality Management District Rule No. 1168.
2. Primers, Sleeves, Forms, Insulation, Packing, Stuffing, and Accessories: Type required for tested assembly design.

2.4 FLASHING

A. Built-up Bituminous Membrane Roof Flashing

1. Composition Flashing System: Composition flashing system shall be by the same manufacturer as the roofing system, and shall be asphalt-saturated and coated felt, reinforced with woven cotton fabric.
2. Flashing Cement: Bituminous product expressly recommended by the roofing materials manufacturer for flashing work on vertical surfaces, asphaltic flashing cement or flashing compound of troweling consistency.
3. Fabric Reinforcement: Asphalt-saturated cotton fabric, treated with asphaltic resin, meeting requirements of ASTM D173, or woven glass fabric, treated with asphalt resin, meeting requirements of ASTM D1668, as applicable.
4. Bituminous Plastic Cement: Asphaltic plastic cement, meeting requirements of ASTM D2822 or D4586.

PART 3 - EXECUTION

3.1 ABOVE GROUND PENETRATION INSTALLATION

- A. Set sleeves in position in formwork. Provide reinforcing around sleeves. All sleeves shall be set true to line, level, plumb and position.
- B. Where insulated ducts or pipes which pass through sleeves, the sleeves shall be of sufficient size to permit the full specified thickness of insulation to pass through sleeves.
- C. Where piping or ductwork penetrates floors, extend sleeves through the floor 1" above finished floor level. Pack the annular space with fiberglass insulation and caulk air tight. Provide a chrome-plated steel escutcheon cover at both sides of the penetration.
- D. Where piping or ductwork penetrates wet floors extend sleeves through the floor 2" above finished floor level. Pack the annular space with fiberglass insulation and caulk water tight. Provide a chrome-plated steel escutcheon cover at both sides of the penetration.
- E. Wet floor areas include:
 1. Kitchens
 2. Toilet Rooms
 3. Showers
 4. Laboratories
 5. Equipment Rooms

- F. Where piping or ductwork penetrates fire rated floors, ceilings, or walls, all pipe and duct penetrations shall installed per an applicable UL fire rated assembly. Contractor shall provide documentation of the UL assembly utilized for each type of penetration at close out.
- G. The contractor shall not drill holes through, cut or otherwise damage any beam or column of the building's structural frame.

3.2 PENETRATIONS THROUGH FOUNDATION WALLS AND BELOW GRADE WALLS INSTALLATION

- A. Determine the required inside diameter of each individual wall opening or sleeve before ordering, fabricating or installing. The inside diameter of each wall opening shall be sized as recommended by the manufacturer to fit the pipe and seal to provide a water tight joint. Sizing (correct seal model and number of links per seal) may be obtained through manufacturer's catalog. If pipe O.D. is non-standard due to coating, insulation, etc., consult manufacturer for recommendation before proceeding with wall opening detail.
- B. Mechanical Contractor shall familiarize his installing personnel with manufacturers Seal instruction bulletin which should illustrates the proper procedure for installing and tightening the seal to provide a water-tight pipe penetration.
- C. Support piping independently of link seal. Refer to Division 20 Section "Hangers and Supports."

3.3 FIRE RATED PENETRATION INSTALLATION

- A. Apply fire stopping material in strict accordance with manufacturer's specific UL system number.
- B. Provide identification label for each penetration stating UL system number, date of installation, installing company name, and rating number.
- C. Penetration shall be free of debris and dirt.
- D. Dam the penetration (when required) with an acceptable material.
- E. Apply material to the penetration. Use a caulking gun, putty knife or other normal trade tools per manufacturer's instructions.
- F. Provide proper material thickness to assure that fire rating is equal to or greater than floor or wall pipe is penetrating.

3.4 FLASHING

- A. Built-up Bituminous Roof Flashing
 - 1. Flashing shall be installed at junctures in the roofing system; in the angles formed where the roof deck abuts curbs, ventilators, pipes, and other vertical surfaces; and where necessary to make the work watertight; and in accordance with the membrane manufacturer's requirements and recommendations.
 - 2. Outlets: Properly seal drains, outlets, and penetrations in accordance with roofing manufacturer's specifications and as indicated.
 - 3. Pipes, vents, gravel stops, and flashings: Install flanges of such items on top of last roofing ply in full bed of plastic cement ¼" thick. Flanges shall then be covered with two additional plies of felt, 4" and 6" inches respectively, in full bed of plastic cement, feathered onto roofing.
 - 4. Flashing systems shall consist of an approved system of the roofing materials manufacturer, and shall be applied over flat portion of roof perimeters and extended up over cant strips and up sloping and vertical surfaces fully height to under metal counterflashings. Roof flashings

shall be left in watertight condition by applying plastic cement to any and all areas not yet covered by metal flashings or counterflashings.

5. Apply fabric reinforcement in hot asphalt or plastic cement at transitions, over joints, cracks, and other surfaces where fabric reinforcement is required or recommended.

3.5 CLEANING

- A. Clean sleeves with fire, smoke and fume stopping materials as follows.
 1. Remove damming materials where necessary after material has cured.
 2. Clean up adjacent surfaces with Xylene or other approved cleaning agent.

END OF SECTION

P:\22 Projects\22-1142-00coev\04 Design\07 Specs\Div 20\20 0517 Penetrations for M-P-FP.docx

SECTION 20 0519
METERS AND GAUGES FOR MECHANICAL, PLUMBING, AND FIRE SUPPRESSION

PART 1 - GENERAL

1.1 SCOPE OF WORK

- A. Meters and gauges specifically applicable to Divisions 20, 21, 22, and 23, including:
 - 1. Thermometers for piping
 - 2. Pressure gauges for piping
 - 3. Test plugs for piping

1.2 CODES AND STANDARDS (USE LATEST EDITION)

- A. American Society of Mechanical Engineers (ASME)
 - 1. ASME B40.100: Pressure Gauges and Gauge Attachments
 - 2. ASME B40.200: Thermometers, Direct Reading and Remote Reading
 - 3. ASME B40.3: Bimetallic Actuated Thermometers

1.3 SUBMITTALS

- A. Preconstruction – Prior to construction provide the following in accordance with Division 01 and Specification 20 0500 – Basic Requirements for Mechanical, Plumbing, and Fire Suppression:
 - 1. Product Data: Submit manufacturer’s product literature for each type of product indicate and a schedule indicating manufacturer’s model number, scale range, and location for each device.
- B. Contract Closeout – At contract closeout provide the following in accordance with Division 01 and Specification 20 0500 – Basic Requirements for Mechanical, Plumbing, and Fire Suppression:
 - 1. Operating and Maintenance Data including:
 - a. Product data
 - b. Installation instructions
 - c. Assembly drawings
 - d. Replacement parts list
 - e. Maintenance and operation instructions
 - f. Schedule indicating device type and location
 - 2. Warranties

PART 2 - PRODUCTS

2.1 LIQUID-IN-GLASS OR DIGITAL THERMOMETERS FOR PIPING

- A. Acceptable Manufacturers
 - 1. Ashcroft Inc.
 - 2. H.O. Trerice Company
 - 3. Miljoco Corporation

4. Weiss Instruments, Inc.
- B. Direct reading liquid-in-glass thermometer complying with ASME B40.200
1. Case: Die-cast aluminum, 7" long
 2. Tube: Blue colored spirit (organic) filled, lens front
 3. Tube Background: Aluminum white with permanently etched scale calibration in °Fahrenheit
 4. Window: Clear acrylic or glass; provide glass for steam and condensate applications
 5. Connector: Adjustable angle joint with positive locking device
 6. Stem: Brass of length to suit installation
 7. Accuracy: ±1% scale division
 8. Thermowells: Brass, pressure-tight, socket-type fitting made for insertion into piping and of type, diameter, and length required to hold thermometer clear of any pipe insulation.
 9. Basis of Design: H.O. Trerice Company Model AX9-2
- C. Digital Thermometers
1. Light Powered, no batteries shall be required.
 2. Sensor: Glass passivated thermistor
 3. 7" aluminum case size (case sizes may differ by manufacturer).
 4. 9/16" LCD Display with Max/Min Feature and °C/F switchable.
 5. Range -40° to 300°F
 6. Provide thermowell – see above.
 7. 1% or 1°F accuracy whichever is greater, 10 second update interval.
 8. Minimum illumination required 10 lux (one candle).
 9. Stem shall be industrial aluminum 3.5" or 6" as required to fit application.
 10. Basis of design H.O. Trerice model SX-9 Solar Therm.

2.2 PRESSURE GAUGES FOR PIPING

- A. Acceptable Manufacturers
1. Ashcroft Inc.
 2. H.O. Trerice Co.
 3. Miljoco Corporation
 4. Weiss Instruments, Inc.
- B. Dial type pressure gauge complying with ASME B40.100
1. Case: 4½" diameter black aluminum
 2. Pressure Element Assembly: Bronze bourdon tube
 3. Pressure Connection: Brass socket
 4. Movement: Rotary stainless steel

5. Dial: Aluminum with permanently etched black scale calibrated in psi on white background
 6. Window: Clear glass
 7. Accuracy: $\pm 0.5\%$ of full scale
 8. Basis of Design: H.O. Trerice Company Model 500XB
- C. Pressure Gauge Accessories
1. Valves
 - a. $\frac{1}{4}$ NPT brass needle valve for a maximum pressure of 600 psig
 - b. Basis of Design: H.O. Trerice Company Series 735
 2. Impulse Dampeners
 - a. Brass with $\frac{1}{4}$ NPT connection
 - b. Basis of Design: H.O. Trerice Company Series 870
 3. Coil Syphons
 - a. Seamless brass, schedule 40, $\frac{1}{4}$ NPT connections
 - b. H.O. Trerice Company Series 885

2.3 TEST PLUGS FOR PIPING

- A. Acceptable Manufacturers
1. Petersen Products Co.
 2. Sisco Manufacturing Company, Inc.
 3. H.O. Trerice Company
 4. Watts Water Technologies
- B. Test Plug (for uninsulated pipe)
1. $\frac{1}{4}$ " by $1\frac{1}{2}$ " long brass fitting for receiving $\frac{1}{8}$ " outside diameter pressure or temperature probe
 - a. Core inserts: Two self-sealing rubber valve cores with a color coded cap strap with gasket
 - (1) Neoprene (maximum 200°F) at 500 psi
 - (2) Nordel (maximum 275°F) at 500 psi
 - b. Minimum Pressure and Temperature Rating: 1000 psi at 140°F
 - c. Basis of Design: Model 100 (neoprene core) or Model 110 (Nordel core) manufactured by Petersen Products Co.
- C. Test Plug (for insulated pipe)
1. $\frac{1}{4}$ " by 3" long brass fitting for receiving $\frac{1}{8}$ " outside diameter pressure or temperature probe
 - a. Core Inserts: Two self-sealing rubber valve cores with a color coded cap strap with gasket
 - (1) Neoprene (maximum 200°F) at 500 psi
 - (2) Nordel (maximum 275°F) at 500 psi
 - b. Minimum Pressure and Temperature Rating: 1,000 psi at 140°F
 - c. Basis of Design: Model 100XL (neoprene core) or Model 110XL (Nordel core) manufactured by Petersen Products Co.

2.4 HYDRONIC INDICATION SYSTEM (COMPOUND PRESSURE GAUGE AND TRUMPET VALVE)

- A. Acceptable Manufacturers
 - 1. Flow Conditioning Corp.
- B. Hydronic indication systems shall consist of hydronic indicator (compound gauge) and four-port trumpet valve model TV-4 by Flow Conditioning Corp.
 - 1. Hydronic indicator shall have 1% accuracy. Steel case shall be 4½", stem mounted with screwed ring and crystal. Indicator shall have re-calibrator, compound scale calibrated in psi and feet from full vacuum to selected pressure and quick set dial for pressure comparison. Maximum indicator pressure shall exceed pump working pressure by minimum 50 psi.
 - 2. Trumpet valve shall have spring return push button manifold of rugged brass construction with ports for connection to system at indicated points and with test connection for gauge calibration.

PART 3 - EXECUTION

3.1 APPLICATIONS

- A. Pressure Gauges
 - 1. Provide pressure gauges in locations indicated on drawings with a scale range of those shown below such that the range is between 1½ and 2 times the operating pressure of the system.
 - a. 0-15 psi
 - b. 0-30 psi
 - c. 0-60 psi
 - d. 0-100 psi
 - e. 0-160 psi
 - f. 0-200 psi
 - g. 0-300 psi
 - h. 0-400 psi
- B. Thermometers
 - 1. Install liquid-in-glass thermometers in all chilled water, hot water, condenser water, steam and condensate piping applications in locations shown on drawings and with ranges as shown in the following table:

SYSTEM	RANGE (°F)
Heating hot water	30F to 240F with 2F scale divisions

3.2 INSTALLATION

- A. Install in accordance with manufacturer's instructions.
- B. Install gauges and thermometers in locations where they are easily read from normal operating level.
- C. Thermometers for Pipes
 - 1. Install direct-mounting thermometers and adjust vertical and tilted positions.

2. Install thermometers in piping systems in thermowells with socket extending to center of pipe or a minimum of 2" into fluid for piping less than 4". Enlarge pipes smaller than 2½" for installation of thermowells.

D. Pressure Gauges for Pipes

1. Install direct-mounting pressure gauges in piping tees with pressure gauge located on pipe at most readable position.
2. Provide needle valve and impulse dampener for each pressure gauge installed in pipe carrying all fluids except steam.
3. Provide needle valve and coil siphon fitting for each pressure gauge installed in pipe carrying steam.

E. Install test plugs in tees in piping where indicated.

F. Hydronic Indication System for Pumps

1. Install hydronic indication system on pumps as indicated on drawings.
2. Hydronic indication system shall be reliably and permanently attached to piping with heavy bracket at convenient height. Connect the system to the following ports:
 - a. Upstream of strainer/suction diffuser
 - b. Downstream of strainer/suction diffuser (pump inlet).
 - c. Pump discharge
 - d. Downstream of discharge isolation valve

END OF SECTION

P:\22 Projects\22-1142-00coev\04 Design\07 Specs\Div 20\20 0519-Meters and Gauges for M-P-FP.docx

SECTION 20 0529
HANGERS AND SUPPORTS FOR MECHANICAL, PLUMBING AND FIRE SUPPRESSION SYSTEMS

PART 1 - GENERAL

1.1 SCOPE OF WORK

- A. Hangers and supports specifically applicable to Divisions 20, 21, 22, and 23, including:
 - 1. Pipe Hangers and Supports
 - 2. Duct Hangers
 - 3. Equipment Hangers and Supports
 - 4. Thermal Hanger Shields and Inserts
 - 5. Upper Attachments
 - 6. Multiple Pipe Supports
 - 7. Hanger Rods
 - 8. Roof Supports
 - 9. Miscellaneous materials

1.2 CODES AND STANDARDS

- A. American Society of Mechanical Engineers (ASME)
 - 1. ASME B31.1: Power Piping
 - 2. ASME B31.5: Refrigeration Piping
 - 3. ASME B31.9: Building Services Piping
- B. American Society for Testing and Materials (ASTM)
 - 1. ASTM A1011: Specification for Steel, Sheet and Strip, Hot-Rolled, Carbon, Structural, High-Strength Low-Alloy and High-Strength Low-Alloy with Improved Formability (*Formerly ASTM A570*)
 - 2. ASTM A123: Specification for Zinc (Hot-Galvanized) Coatings on Products Fabricated from Rolled, Pressed, and Forged Steel Shapes, Plates, Bars, and Strip
 - 3. ASTM A36: Steel Plates, Shapes and Bars
 - 4. ASTM A653: Specification for Steel Sheet, Zinc-Coated by the Hot-Dip Process
 - 5. ASTM B633: Specification for Electrodeposited Coatings of Zinc on Iron and Steel
 - 6. ASTM C150: Portland Cement
 - 7. ASTM C404: Uniformly Graded Natural Sand
 - 8. ASTM E-814: Fire Tests of Through-Penetration Fire Stops
- C. American Welding Society (AWS)
 - 1. Specifications for Qualification of Welding Procedures and Welders
- D. American Water Works Association (AWWA)

- E. Building Officials and Code Administrators International (BOCAI)
 - 1. BOCA: National Building Code
 - 2. BOCA: National Mechanical Code
- F. International Conference of Building Officials (ICBO)
 - 1. ICBO: Uniform Building Code
- G. Manufacturers Standardization Society of the Valve and Fittings Industry (MSS)
 - 1. MSS SP 58: Pipe Hangers and Supports - Materials, Design, Manufacture, Selection, Application, and Installation
 - 2. MSS SP 89: Pipe Hangers and Supports - Fabrication and Installation Practices
- H. National Fire Protection Association (NFPA)
 - 1. NFPA 13: Standard for the Installation of Sprinkler Systems
 - 2. NFPA 14: Standard for the Installation of Standpipe and Hose Systems
 - 3. NFPA 101: Code for Safety to Life from Fires in Buildings and Structures
- I. Southern Building Code Congress International (SBCCI)
 - 1. SBCCI: Standard Building Code
- J. Sheet Metal and Air Conditioning Contractors' National Association (SMACNA)
 - 1. SMACNA: HVAC Duct Construction Standards, Metal and Flexible
- K. Underwriters Laboratories, Inc. (UL)
 - 1. UL 1479: Fire Tests of Through Penetration Firestops and Building Joint Systems
- L. Factory Mutual (FM)

1.3 QUALITY ASSURANCE

- A. Supports for Mechanical and Plumbing Piping: Provide products in compliance with MSS Standards:
 - 1. Provide pipe hangers and supports of which materials, design and manufacture comply with MSS SP-58.
 - 2. Select and apply pipe hangers and supports, complying with MSS SP-58.
 - 3. Fabricate and install pipe hangers and supports, complying with MSS SP-89.
 - 4. Terminology used in this section is defined in MSS SP-90.
- B. Supports for Sprinkler Piping: Provide products which are UL listed and FM approved and in conformance with NFPA 13.
- C. Supports for Standpipes: Provide products which are UL listed and FM approved and in conformance with NFPA 14.
- D. Structural Steel Welding Qualifications: Qualify procedures and personnel according to AWS D1.1/D1.1M, "Structural Welding Code - Steel."
- E. Pipe Welding Qualifications: Qualify procedures and operators according to ASME Boiler and Pressure Vessel Code.

1.4 SUBMITTALS

- A. Preconstruction – Prior to construction provide the following in accordance with Division 01 and Specification 20 0500 – Basic Requirements for Mechanical, Plumbing, and Fire Suppression:
 - 1. Product Data: Submit product data on all hanger and support devices, including shields and attachment methods. Product data to include, but not limited to materials, finishes, approvals, load ratings, and dimensional information.
- B. Contract Closeout – At contract closeout provide the following in accordance with Division 01 and Specification 20 0500 – Basic Requirements for Mechanical, Plumbing, and Fire Suppression:
 - 1. Warranties

1.5 DELIVERY, STORAGE AND HANDLING

- A. Accept materials on site in original factory packaging, labeled with manufacturer's identification.
- B. Protect from weather and construction traffic, dirt, water, chemical, and damage, by storing in original packaging.

PART 2 - PRODUCTS

MSS Types are shown in diagrams at end of document for reference.

2.1 PIPE HANGERS AND SUPPORTS

- A. Acceptable Manufacturers
 - 1. B-Line Systems, Inc.
 - 2. Fee and Mason Manufacturing Company
 - 3. Anvil International
 - 4. Hilti
- B. Construction
 - 1. General Service
 - a. Interior insulated pipe: Carbon steel with plain electro-galvanized finish
 - b. Exterior insulated pipe: Carbon steel with hot-dip galvanized finish after fabrication
 - c. Interior uninsulated steel, cast iron, ductile iron and plastic pipe: Carbon steel with plain electro-galvanized finish
 - d. Exterior uninsulated steel, cast iron, ductile iron and plastic pipe: Carbon steel with hot-dip galvanized finish after fabrication
 - e. Interior uninsulated copper pipe: Carbon steel with copper plated or epoxy coated finish
 - f. Exterior uninsulated copper pipe: Carbon steel with copper plated or epoxy coated finish
 - g. Interior glass pipe: Carbon steel with plastic or vinyl coated finish
- C. Piping system classification
 - 1. Type A-1 Hot Systems (120°F - 450°F)
 - a. Heating Water
 - 2. Type B Ambient Systems (60°F - 119°F)
 - a. Natural Gas

- b. Condensate Drain
- c. Fire Suppression

Pipe supports shall be provided as indicated in the table below.

PIPE HANGER AND SUPPORT MSS TYPES – PART 1									
Class		A-1				B			
Pipe Size		≤2"		>2"		≤2"		>2"	
Insulation ¹		YES	NO	YES	NO	YES	NO	YES	NO
Horizontal Pipe Attachments	Steel Clips	24 w/ 39	24 & 26	24 w/ 39	24 & 26	24 & 26	24 & 26	24 & 26	24 & 26
	Malleable Iron Rings	N/A	6, 11, & 12	N/A	6, 11, & 12	N/A	6, 11, & 12	N/A	6, 11, & 12
	Steel Bands	1 w/ 40	1	1 w/ 39	1	1 w/ 40	1	1 w/ 40	1
	Steel Clamps	2 & 3	3 & 4	2 & 3	3 & 4	3 & 4	3 & 4	3 & 4	3 & 4
	Cast Iron Hanging Rolls	N/A	N/A	41 & 43 w/ 39	41 & 43	N/A	N/A	41 & 43 w/ 39	41 & 43
	Cast Iron Supporting Rolls	N/A	N/A	44, 45, & 46 w/ 39	44, 45, & 46	N/A	N/A	44, 45, & 46 w/ 39	44, 45, & 46
	Steel Trapezes	59 w/ 40	59	59 w/ 39	59	59 w/ 40	59	59 w / 39	N/A
	Steel Protection Saddles and Shields	39 & 40	N/A	39	N/A	40	N/A	39	N/A
	Steel or Cast-Iron Stanchions	36, 37, & 38 w/ 40	36, 37, & 38	36, 37, & 38 w/ 39	36, 37, & 38	36, 37, & 38 w/ 40	36, 37, & 38	36, 37, & 38 w/ 39	36, 37, & 38
	Steel Welded Attachments	35 ²		35 ²		35 ²		35 ²	

1. Hangers on insulated systems shall incorporate protection saddles or shields or shall be clamped or welded to the pipe and project through the insulation to provide external attachment.
2. The design shall be in accordance with MSS SP-58.

PIPE HANGER AND SUPPORT MSS TYPES – PART 2

Class		C-1				C-2			
Pipe Size		≤2"		>2"		≤2"		>2"	
Insulation ¹		Yes	No	Yes	No	Yes	No	Yes	No
Horizontal Pipe Attachments	Steel Clips	26 w/40	24 & 26	26 w/40	24 & 26	N/A	N/A	N/A	N/A
	Malleable Iron Rings	N/A	6, 11, & 12	N/A	6, 11, & 12	N/A	N/A	N/A	N/A
	Steel Bands	1 w/ 40	1	1 w/ 40	1	1 w/ 40	1	1 w/ 40	1
	Steel Clamps	3 & 4	3 & 4 w/ 40	3 & 4	3 & 4 w/ 40	N/A	3 & 4	N/A	3 & 4
	Cast Iron Hanging Rolls	N/A	N/A	41 & 43 w/ 40	41 & 43	N/A	N/A	41 & 43 w/ 40	41 & 43
	Cast Iron Supporting Rolls	N/A	N/A	44, 45 & 46, w /39	44, 45, & 46	N/A	N/A	44, 45 & 46, w /39	44, 45, & 46
	Steel Trapezes	59 w/ 40	N/A	59 w/ 40	N/A	N/A	N/A	N/A	N/A
	Steel Protection Saddles and Shields	40	N/A	40	N/A	40	N/A	40	N/A
	Steel or Cast-Iron Stanchions	36, 37, & 38 w/40	36, 37, & 38	36, 37, & 38 w/40	36, 37, & 38	36, 37, & 38 w/40	36, 37, & 38	36, 37, & 38 w/40	36, 37, & 38
	Steel Welded Attachments	35 ²		35 ²		35 ²		35 ²	

- Hangers on insulated systems shall incorporate protection saddles or shields or shall be clamped or welded to the pipe and project through the insulation to provide external attachment.
- The design shall be in accordance with MSS SP-58.

PIPE HANGER AND SUPPORT MSS TYPES – PART 3						
Class		A-1	B	C-1	C-2	
Vertical Pipe Attachments	Steel Riser Clamps (2-Bolt)	8	8	8	8	
	Steel Riser Clamps (4-Bolt) ¹	42	42	42	42	
Hanger Rod Fixtures	Steel or Malleable Iron	Turn Buckles	13 & 15	13 & 15	13 & 15	
		Swing Eyes	16 & 17	16 & 17	16 & 17	
		Clevises	14	14	14	
Building Structure Attachments	Steel and/or Malleable Iron	Inserts ²	18	18	18	
		C-Clamps ³	19 & 23	19 & 23	19 & 23	
		Beam Clamps ⁴	20, 21, 25, 27, 28, 29, & 30	20, 21, 25, 27, 28, 29, & 30	20, 21, 25, 27, 28, 29, & 30	20, 21, 25, 27, 28, 29, & 30
		Welded Attachments ¹	22, 57, & 58	22, 57, & 58	22, 57, & 58	22, 57, & 58
		Brackets	31, 32, 33, & 34	31, 32, 33, & 34	31, 32, 33, & 34	31, 32, 33, & 34

1. The design shall be in accordance with MSS SP-58.
2. Refer to 2.7 – Upper Attachments for approved inserts.
3. All C-Clamps shall be provided with a retaining strap held securely to the clamp with a hex nut or locking slot. C-Clamps shall not be used with bar joist structure.
4. Clamps for direct attachment to bar joist structure shall be MSS Type 21 center beam clamp located at the plates along the bottom or top chord of the joist.

2.2 DUCT HANGERS

A. Threaded Rod Type

1. Duct hangers shall be strips of galvanized steel or round steel rod and shall comply with SMACNA - HVAC Duct Construction Standards, Metal and Flexible.
2. Trapeze and Riser Supports:
 - a. Supports for Galvanized-Steel Ducts: Galvanized-steel shapes and plates
 - b. Supports for Stainless-Steel Ducts: Stainless-steel shapes and plates
 - c. Supports for Aluminum Ducts: Aluminum or galvanized steel coated with zinc chromate
3. Attachments: Equipment support shall be directly attached to the building structure utilizing an upper attachment or by utilizing a building structure attachment as indicated in the Pipe Hanger and Support MSS Types – Part 3 table as specified in Division 20 Section “Hangers and Supports for Mechanical, Plumbing, Medical Gas, and Fire Suppression.”

B. Cable Type

1. Approved Manufacturers
 - a. Gripple
 - b. Duro Dyne
2. Cable type duct hangers shall be an engineered manufactured product supplied as a complete duct hanging system by the manufacturer.
3. Cable type duct hangers shall be provided and installed according to the manufacturer's recommendations.
4. Cable Lock
 - a. Cable locks shall have an ultimate breaking strength of at least 5 times the published working load limit.
 - b. Cable locks shall be constructed of zinc alloy for interior use and stainless steel for exterior use.
 - c. Cable locks shall be suitable for use up to 300°F.
5. Cable
 - a. Wire rope shall be galvanized steel of $\frac{3}{16}$ " or $\frac{1}{8}$ " diameter.
 - b. All wire rope shall have an ultimate breaking strength of at least 5 times the published working load limit.
6. Duct Trapeze
 - a. Duct trapeze bracket shall include a cable lock which fastens to the duct utilizing sheet metal screws.
 - b. Duct trapeze bracket shall have an ultimate breaking strength of at least 5 times the published working load limit.
7. Upper Attachments
 - a. Stud
 - (1) Zinc coated steel threaded rod stud for connection of cable to building structure.
 - (2) Stud shall be connected to structure by screwing into a drop-in anchor set in concrete structure or by screwing into a C-clamp (MSS Type 19 or 23) or beam clamp (MSS Types 20, 21, 25, 27, 28, 29, or 30) attached to steel structure.
 - (3) Stud shall have an ultimate breaking strength of at least 5 times the published working load limit.
 - b. Loop
 - (1) Loop cable around building structure and lock utilizing cable lock.

2.3 EQUIPMENT HANGERS AND SUPPORTS

A. Equipment Pads

1. Pads shall be nominal 4" high and shall extend a minimum of 4" beyond all equipment and supports while generally conforming to the shape of the equipment.
2. Pads shall be minimum 2500 psi (28 day) concrete reinforced with No. 6 – 6" x 6" welded wire mesh. Pad tops and sides shall be hard troweled smooth with a $\frac{3}{4}$ " bull nose on all external corners. Refer to Division 03 for additional requirements.

3. Furnish galvanized anchor bolts with layout templates for installation in equipment pads. Bolts shall be of the size and quantity recommended by the manufacturer and where vibration isolators are used, they shall be anchor bolted to the equipment pad.
 4. Equipment mounted to pads shall be provided with vibration isolation supports indicated in Division 20 Specification "Vibration Isolation for Mechanical, Plumbing, and Fire Suppression".
- B. Hanging Equipment
1. Description: Welded, shop- or field-fabricated equipment support made from structural carbon-steel shapes.
 2. Structural Steel: ASTM A36/A 36M, carbon-steel plates, shapes, and bars; black and galvanized.
 3. Attachments: Equipment support shall be directly attached to the building structure utilizing an upper attachment or by utilizing a building structure attachment as indicated in the Pipe Hanger and Support MSS Types – Part 3 table as specified in Division 20 Section "Hangers and Supports for Mechanical, Plumbing, Medical Gas, and Fire Suppression."
 4. Hanging equipment shall be provided with vibration isolation hangers indicated in Division 20 Specification "Vibration Isolation for Mechanical, Plumbing, and Fire Suppression."

2.4 THERMAL HANGER SHIELDS AND INSERTS

- A. Acceptable Manufacturers:
1. Clement Support Services, Inc.
 2. Pipe Shields, Inc.
 3. Value Engineered Products, Inc.
- B. Thermal hanger shields shall be used on all horizontal insulated pipe systems at each point of support. Manufactured units shall comply with MSS SP-58 standards and be tested per MSS SP-89 guidelines. Thermal hanger shields shall meet the requirements of MSS Type 40. Each assembly shall closely fit the various pipe diameters and match the outside diameter of the adjoining pipe insulation.
- C. Individual components shall not exceed a Flame Spread and Smoke Developed rating of 25/50 per ASTM E84.
- D. Safety Ratio shall be minimum 3:1.
- E. Insulation-Insert Material for Hot Water Piping up to 200F: Water-repellent treated, ASTM C 533, Type I calcium silicate with 100-psig minimum compressive strength or ASTM C 591, Type VI, Grade 1 polyisocyanurate with 125-psig minimum compressive strength. All service jacket.
- F. Insulation-Insert Material for Steam or other Hot Piping up to 1200F: Water-repellent treated, ASTM C 533, Type I calcium silicate with 100-psig minimum compressive strength. All service jacket.
- G. For Trapeze or Clamped Systems: Insert and shield shall cover entire circumference of pipe.
- H. For Clevis or Band Hangers: Insert and shield shall cover lower 180° of pipe.
- I. A rolled shield of G-90 galvanized steel shall be an integral part of the unit and shall be of a gauge and length appropriate for the compressive strength of the insert material and type of hanger.
- J. Insert Length: Extend 2 inches beyond sheet metal shield to provide a complete, neat and vapor-tight seal with the adjoining insulation.

K. Hanger types and span between hangers shall govern the type of thermal hanger shield used.

2.5 UPPER ATTACHMENTS

A. Concrete Inserts

1. Continuous
 - a. Approved Manufacturers
 - (1) B-Line Systems, Inc.
 - (2) Fee and Mason Manufacturing Company
 - (3) Anvil International
 - (4) Unistrut
 - b. MSS type 18 12 gauge ASTM A1011 SS Grade 33 structural carbon steel cast in place channel with styrofoam insert and end caps with nail holes for attachment to forms.
2. Adjustable Spot
 - a. Approved Manufacturers
 - (1) B-Line Systems, Inc.
 - (2) Fee and Mason Manufacturing Company
 - (3) Anvil International
 - b. MSS type 18 malleable iron spot cast in place insert with lateral adjustment
 - c. MSS type 18 12 gauge ASTM A1011 SS Grade 33 structural carbon steel cast in place channel with styrofoam insert and end caps with nail holes for attachment to forms
3. Spot
 - a. Approved Manufacturers
 - (1) Cooper B-Line
 - (2) Hilti
 - (3) Powers
 - b. Color coded, six sided cast in place wood knocker insert with nails for attachment to forms, capable of accepting threaded rod from 1/4" to 3/4" in diameter

B. Concrete and Masonry Drilled In Anchors

1. Wedge Anchor
 - a. Approved Manufacturers
 - (1) ITW Red Head
 - (2) Hilti
 - (3) Powers
 - b. Wedge type, torque-controlled, with impact section to prevent thread damage complete with required nuts and washers. Provide anchors with length identification markings conforming to ICC ES AC01 or ICC ES AC193.
 - c. Anchor shall be listed with ICC-ES.
 - d. Interior Use: Carbon steel anchors with zinc plating
 - e. Exterior Use: Stainless steel anchors of AISI Type 304 stainless steel provided with stainless steel nuts and washers of matching alloy group and minimum proof stress equal to or greater than the specified minimum full-size tensile strength of the externally threaded

fastener. Stainless steel nuts shall conform to ASTM F594 unless otherwise specified. Avoid installing stainless steel anchors in contact with galvanically dissimilar metals.

- f. Basis of Design: Hilti Kwik Bolt 3
- 2. Screw Anchors
 - a. Approved Manufacturers
 - (1) ITW Red Head
 - (2) Hilti
 - (3) Powers
 - b. Screw type: Pre-drilling of the hole requires a standard ANSI drill bit with the same diameter as the anchor and installing the anchor will be done with an impact wrench. Provide anchors with a diameter and anchor length marking on the head.
 - c. Anchor shall be listed with ICC-ES.
 - d. Interior Use: Carbon steel anchors with zinc plating
 - e. Basis of Design: Hilti Kwik-Hus
 - 3. Drop-in Anchor
 - a. Approved Manufacturers
 - (1) ITW Red Head
 - (2) Hilti
 - b. Drop-in, shell type internally threaded anchor with expansion cone insert and flush embedment lip
 - c. Anchor shall be listed with ICC-ES.
 - d. Interior Use: Carbon steel anchors with zinc plating
 - e. Exterior Use: Stainless steel
 - f. Anchors shall be listed by ICC-ES
 - g. Basis of Design: Hilti HDI

2.6 MULTIPLE PIPE SUPPORT SYSTEMS

- A. Acceptable Manufacturers
 - 1. Cooper B-Line
 - 2. Anvil International
 - 3. Unistrut Corporation
- B. Multiple Pipe Supports: Pipe supporting elements mounted to cold formed 12 gauge strip steel channel framing with thermoset acrylic finish. Provide specified pipe supporting elements to keep pipe in alignment and allow for expansion. Provide all channel nuts and accessories required to mount pipe supporting elements. Model P1000 by Unistrut.
- C. Strut type trapeze hangers shall be limited to copper tubing systems less than 2" diameter and selected for maximum deflection of 1/4".
- D. Provide tubing clamps at each pipe support.
 - 1. Provide insulation couplings with strut clamp for all insulated piping. Insulation thickness to match that specified for piping.

2. Provide cushion inserts for uninsulated tubing.
- E. Select hanger rods for two times the trapeze loads but not less than $\frac{3}{8}$ " diameter.
- F. Secure hanger rod with square washers and locking nuts on top and bottom of strut.

2.7 HANGER RODS

- A. Dry or Non-corrosive Environments: Continuously threaded carbon steel or 304 stainless steel rods and hardware.
- B. Moist or Corrosive Environments:
 1. Continuously threaded zinc plated (hot dipped galvanized) carbon steel rods and hardware with threads painted with zinc-chromate primer after installation.
 2. Continuously threaded 304 stainless steel rods and hardware.

2.8 ROOF SUPPORTS

- A. Equipment Rail Support
 1. Acceptable Manufacturers:
 - a. Pate
 - b. Thybar
 2. Factory fabricated 18 gauge galvanized sheet steel structural members with internal bulkheads spaced to provide high load-bearing capacity of roof mounted equipment
 3. Support shall incorporate a continuous 2x4 treated wood nailer covered by a removable counter flashing to allow for water tight roofing installation.
 4. Support shall be designed to be compatible with roofing system and roofing pitch.
- B. Duct penetration curb
 1. Acceptable Manufacturers:
 - a. Pate
 - b. Thybar
 2. Factory fabricated 18 gauge galvanized sheet steel curb with full mitered corners, fully welded seams, continuous 2x2 pressure treated wood nailer, and factory installed 1½" thick, 3 pounds per cubic foot density rigid insulation.
 3. 6" high 18 gauge galvanized sheet steel curb adapter reducer with fully mitered corners and fully welded seams and 1½" thick, 3 pounds per cubic foot density rigid insulation shall be provided to adapt the size of the roof curb to the size of the duct penetrating the roof. A foam gasket seal shall be provided between the roof curb and curb adapter reducer.
 4. A 20 gauge galvanized sheet metal collar counterflashed to the curb adapter reducer with a continuous seal of mastic or foil back tape at the duct penetration-collar joint.
 5. Support shall be designed to be compatible with roofing system and roofing pitch.
- C. Permanent duct support
 1. Acceptable Manufacturers:
 - a. Pate DSS/MDSS

2. Factory fabricated 18 gauge galvanized sheet steel support curb with fully welded corner seams, 2x4 pressure treated wood nailer, and 18 gauge galvanized steel counterflashing with galvanized steel channel track attached.
3. Vertical and horizontal adjustable duct mounting assembly of galvanized steel channel track, galvanized steel fittings, washers and nuts.
4. Support shall be designed to be compatible with roofing system and roofing pitch.

2.9 MISCELLANEOUS MATERIALS

- A. Metal Framing: Provide products complying with NEMA STD ML 1.
- B. Steel Plates, Shapes and Bars: Provide products complying with ASTM A 36.
- C. Cement Grout: Portland cement (ASTM C 150, Type I or Type III) and clean uniformly graded, natural sand (ASTM C 404, Size No. 2). Mix at a ratio of 1.0 part cement to 3.0 parts sand, by volume, with minimum amount of water required for placement and hydration.

PART 3 - EXECUTION

3.1 PIPE HANGERS AND SUPPORTS

- A. Hanger and Support Installation
 1. Pipe Hanger Installation: Comply with MSS SP-58 and MSS SP-89. Install hangers, supports, clamps, and attachments as required to properly support piping from the building structure.
 2. Trapeze Pipe Hanger Installation: Comply with MSS SP-58 and MSS SP-89. Arrange for grouping of parallel runs of horizontal piping, and support together on field-fabricated trapeze pipe hangers.
 - a. Pipes of Various Sizes: Support together and space trapezes for smallest pipe size or install intermediate supports for smaller diameter pipes as specified for individual pipe hangers.
 - b. Field fabricate from ASTM A 36/A 36M, carbon-steel shapes selected for loads being supported. Weld steel according to AWS D1.1/D1.1M.
 3. Thermal-Hanger Shield Installation: Install in pipe hanger or shield for insulated piping.
 4. Thermal Hanger Shields and Inserts: Install in accordance with manufacturer's instruction. Seal jacket to adjacent insulation and provide continuous vapor barrier.
 5. Fastener System Installation:
 - a. Install powder-actuated fasteners for use in lightweight concrete or concrete slabs less than 4 inches thick in concrete after concrete is placed and completely cured. Use operators that are licensed by powder-actuated tool manufacturer. Install fasteners according to powder-actuated tool manufacturer's operating manual.
 - b. Install mechanical-expansion anchors in concrete after concrete is placed and completely cured. Install fasteners according to manufacturer's written instructions.
 6. Pipe Stand Installation:
 - a. Pipe Stand Types except Curb-Mounted Type: Assemble components and mount on smooth roof surface. Do not penetrate roof membrane.
 - b. Curb-Mounted-Type Pipe Stands: Assemble components or fabricate pipe stand and mount on permanent, stationary roof curb.

7. Install hangers and supports complete with necessary attachments, inserts, bolts, rods, nuts, washers, and other accessories.
8. Equipment Support Installation: Fabricate from welded-structural-steel shapes.
9. Install hangers and supports to allow controlled thermal and seismic movement of piping systems, to permit freedom of movement between pipe anchors, and to facilitate action of expansion joints, expansion loops, expansion bends, and similar units.
10. Install lateral bracing with pipe hangers and supports to prevent swaying.
11. Install building attachments within concrete slabs or attach to structural steel. Install additional attachments at concentrated loads, including valves, flanges, and strainers, 2-1/2" and larger and at changes in direction of piping. Install concrete inserts before concrete is placed; fasten inserts to forms and install reinforcing bars through openings at top of inserts.
12. Load Distribution: Install hangers and supports so that piping live and dead loads and stresses from movement will not be transmitted to connected equipment.
13. Pipe Slopes: Install hangers and supports to provide indicated pipe slopes and to not exceed maximum pipe deflections allowed by ASME B31.9 for building services piping.

B. Hanger and Support Spacing

1. Pipe shall be adequately supported by pipe hanger and supports specified in Part 3. Hangers for insulated pipes shall be sized to accommodate insulation thickness.
2. Horizontal steel piping shall be supported in accordance with MSS SP-58 Tables 3, 4, and 5, excerpts of which follow below:

MAXIMUM HORIZONTAL PIPE HANGER AND SUPPORT SPACING WITHOUT MSS TYPE 40 SHIELDS (FEET)									
Nominal Pipe or Tube Size	Standard Weight Steel Pipe		Copper Tube		Fire Protection	Ductile Iron Pipe	Cast Iron Soil	Glass	Plastic
	Water Service	Vapor Service	Water Service	Vapor Service					
¼	7	8	5	5	Follow require- ments of the NFPA.	20 feet maximum spacing; minimum of one hanger per pipe section close to the joint behind the bell and at change of direction and branch connections. For pipe sizes 6 inches and under subjected to loadings other than weight of pipe and contents, the span shall be	10 feet maximum spacing; minimum of one hanger per pipe section close to joint on the barrel and at change of direction and branch connections.	8 feet maximum spacing, follow manufacturer's recommendations.	Follow pipe manufacturer's recommenda- tions for material and service condition.
⅜ – ½	7	8	5	6					
¾	7	9	5	7					
1	7	9	6	8					
1¼	7	9	7	9					
1½	9	12	8	10					
2	10	13	8	11					
2½	11	14	9	13					
3	12	15	10	14					
4	14	17	12	16					
5	16	19	13	18					
6	17	21	14	20					
8	19	24	16	23					
10	22	26	18	25					
12	23	30	19	28					
14	25	32	—	—					

**MAXIMUM HORIZONTAL PIPE HANGER AND SUPPORT SPACING
WITHOUT MSS TYPE 40 SHIELDS (FEET)**

Nominal Pipe or Tube Size	Standard Weight Steel Pipe		Copper Tube		Fire Protection	Ductile Iron Pipe	Cast Iron Soil	Glass	Plastic
	Water Service	Vapor Service	Water Service	Vapor Service					
16	27	35	—	—		limited to the maximum spacing for water service steel pipe.			
18	28	37	—	—					
20	30	39	—	—					
24	32	42	—	—					
30	33	44	—	—					

MINIMUM ROD DIAMETER FOR SINGLE RIGID ROD HANGERS

Nominal Pipe or Tubing Size (inches)	Steel, Ductile Iron, and Cast Iron Pipe	Copper, Glass, and Plastic Pipe
	Nominal Rod Diameter (inches)	Nominal Rod Diameter (inches)
¼ - 2	⅜	⅜
2½ - 3	½	½
4 - 5	⅝	½
6	¾	⅝
8	¾	¾
10 - 12	⅞	¾
14 - 18	1	—
20 - 24	1¼	—

MAXIMUM HORIZONTAL PIPE HANGER, SUPPORT, AND SHIELD SPACING WITH MSS TYPE 40 SHIELDS (FT)			
Standard Weight Steel Pipe			
Nominal Pipe Size (inches)	Shield Length (inches)	Shield Thickness (gage)	Hanger and Support Spacing (feet)
½ - 1¼	12	18	7
1½	12	18	9
2 - 3	12	18	10
4	12	16	10
5 - 6	18	16	10
8 - 14	24	14	10
16 - 24	24	12	10
Copper Tubing			
Nominal Pipe Size (inches)	Shield Length (inches)	Shield Thickness (gage)	Hanger and Support Spacing (feet)
¼ - ¾	12	18	5
1	12	18	6
1¼	12	18	7
1½ - 2	12	18	8
2½	12	18	9
3	12	18	10
4	12	16	10
5 - 6	18	16	10
8	24	14	10

3.2 DUCT HANGERS

- A. Duct hanging system shall be at contractor's option. Comply with SMACNA - HVAC Duct Construction Standards, Metal and Flexible and meet with approval of Engineer.
- B. Vertical Ducts Through Floor Slabs: Are to be supported on two sides by galvanized steel angles bolted to duct and resting on floor slab. Supporting angles are to be bolted to floor, ceiling or wall to prevent vibration.
- C. Vertical Ducts In Open Shafts: Provide additional galvanized structural steel members to span openings for support of ducts and angles at each floor.
- D. Ducts Along Walls: Are to have supports spaced not more than 8 feet apart.
- E. Provide hangers at the center of every ell or change in direction of horizontal ductwork.
- F. Wire strap or perforated hangers will not be permitted.

3.3 EQUIPMENT SUPPORTS

- A. Fabricate structural-steel stands to suspend equipment from structure overhead or to support equipment above floor.
- B. Grouting: Place grout under supports for equipment and make bearing surface smooth.
- C. Provide lateral bracing, to prevent swaying, for equipment supports. Ensure that lateral motion under equipment at start-up, shut-down or when unbalanced is no more than ¼ inch.

- D. Provide templates, anchor bolts and accessories for mounting and anchoring equipment.
- E. Provide rigid anchors for pipes after vibration isolation components are installed.
- F. Provide corrosion resistant mounting systems when exposed to the elements and other corrosive environments.

3.4 UPPER ATTACHMENTS

- A. Provide inserts for placement in formwork before concrete is poured.
- B. Provide inserts for suspending hangers from reinforced concrete slabs and sides of reinforced concrete beams.
- C. Provide hooked rod to concrete reinforcement section for inserts carrying pipe over 4".
- D. Where concrete slabs form finished ceiling, provide inserts to be flush with slab surface.
- E. Where inserts are omitted, drill through concrete slab from below and provide thru bolt with recessed square steel plate and nut above slab.
- F. In remodeled areas, provide expanding concrete anchors. Holes for expanding fasteners to be drilled either by carbide bit or by teeth on fastener itself. Expansion shield to be "set" by driving it into hole and expanding it with conical plug.

3.5 ROOF SUPPORTS

- A. Verify that roofing system is complete and roof surfaces are smooth, flat, and ready to receive work of this section.
- B. Clean surfaces of roof in areas to received supports.
- C. Install in accordance with manufacturer's instructions. Provide flexible sheet flash and counterflash with sheet metal and caulk as necessary to make installation water tight. Weld, bolt, or screw roof curbs as instructed by manufacturer.
- D. Equipment Supports
 - 1. Locate bases and support framing as required by equipment manufacturer. Provide complete and adequate support of equipment whether or not all required devices are shown.
- E. Pipe and Duct Supports
 - 1. Locate bases and support framing as indicated on drawings and as specified herein. Provide complete and adequate support of all piping and ducts whether or not all required devices are shown.
 - 2. The use of wood for supporting piping is not permitted.
 - 3. Provide supports spaced so deflection of piping does not exceed L/240 of span.
 - 4. Install framing at spacing indicated, but in no case at greater than 10 feet (3 m) on center.

3.6 METAL FABRICATIONS

- A. Cut, drill, and fit miscellaneous metal fabrications for trapeze pipe hangers.
- B. Fit exposed connections together to form hairline joints. Field weld connections that cannot be shop welded because of shipping size limitations.

- C. Field Welding: Comply with AWS D1.1/D1.1M procedures for shielded, metal arc welding; appearance and quality of welds; and methods used in correcting welding work; and with the following:
 - 1. Use materials and methods that minimize distortion and develop strength and corrosion resistance of base metals.
 - 2. Obtain fusion without undercut or overlap.
 - 3. Remove welding flux immediately.
 - 4. Finish welds at exposed connections so no roughness shows after finishing and so contours of welded surfaces match adjacent contours.

3.7 ADJUSTING

- A. Hanger Adjustments: Adjust hangers to distribute loads equally on attachments and to achieve indicated slope of pipe.
- B. Trim excess length of continuous-thread hanger and support rods to 1½".
- C. Support Adjustment: Provide grout under supports so as to bring piping and equipment to proper level and elevations.

3.8 PAINTING

- A. Touchup: Clean field welds and abraded areas of shop paint. Paint exposed areas immediately after erecting hangers and supports. Use same materials as used for shop painting. Comply with SSPC-PA 1 requirements for touching up field-painted surfaces.
 - 1. Apply paint by brush or spray to provide a minimum dry film thickness of 2.0 mils.
- B. Galvanized Surfaces: Clean welds, bolted connections, and abraded areas and apply galvanizing-repair paint to comply with ASTM A 780.

END OF SECTION

P:\22 Projects\22-1142-00coev\04 Design\07 Specs\Div 20\20 0529 Hangers and Supports for M-P-FP.docx

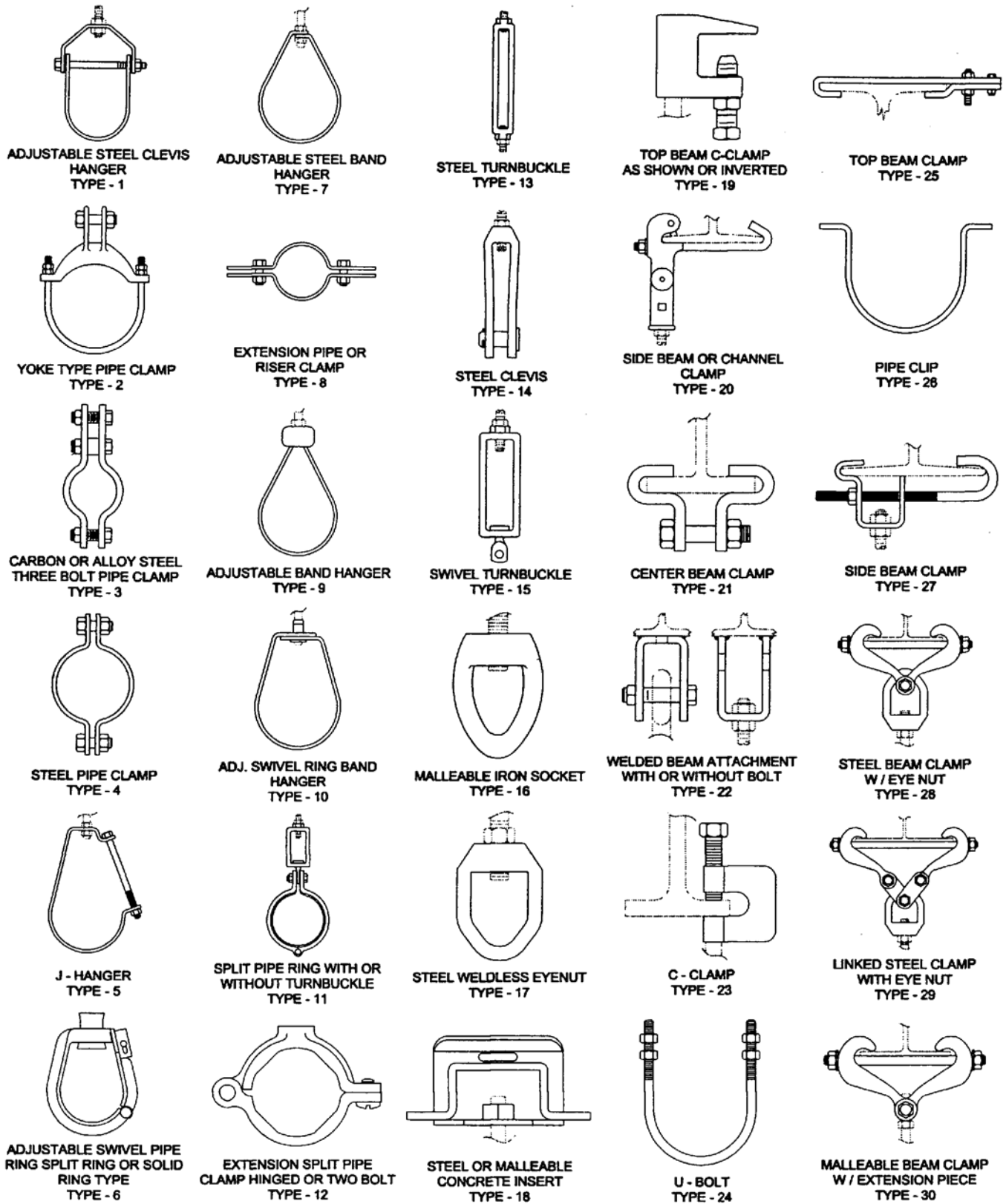

FIGURE 1. TYPE CHART

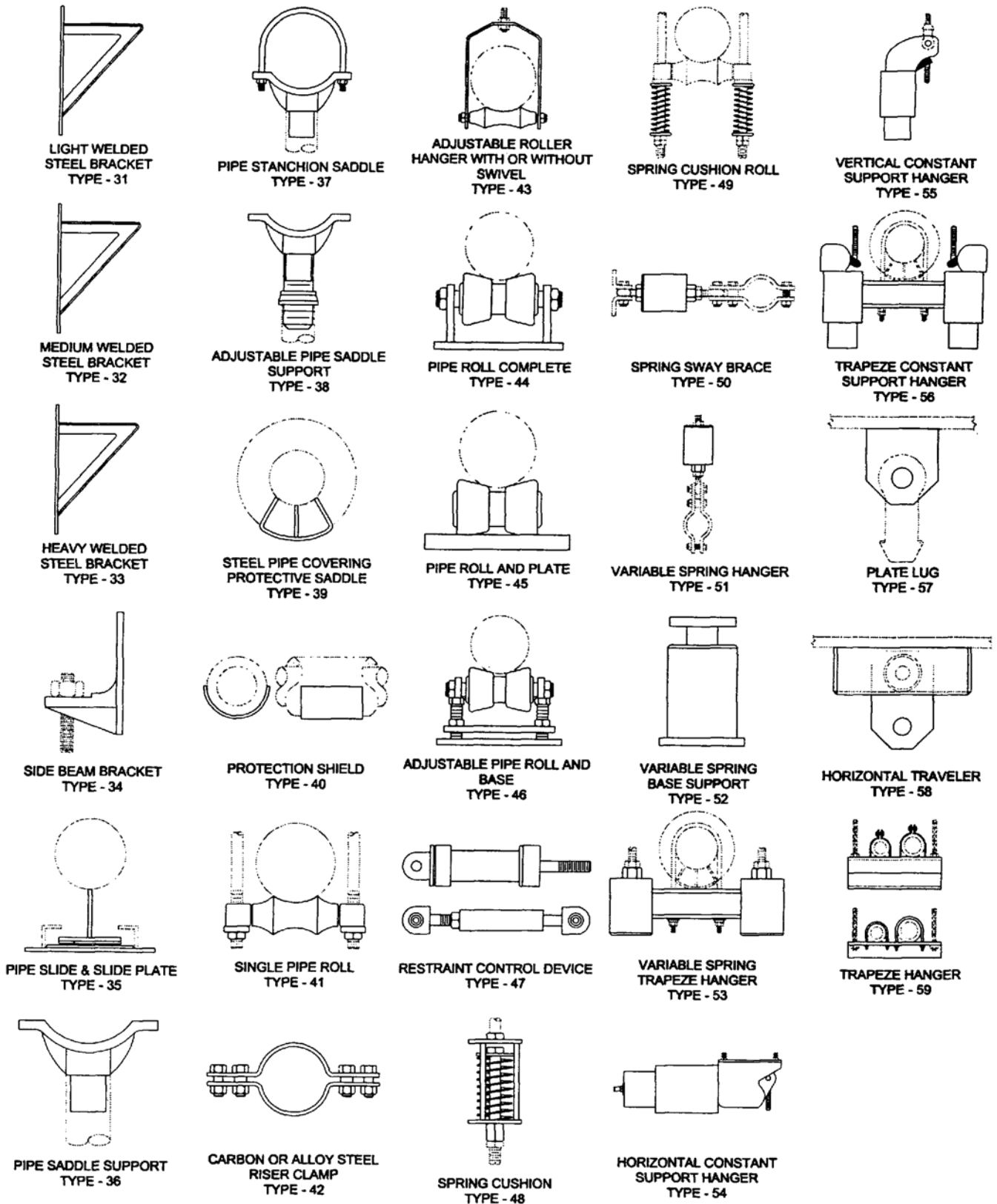

FIGURE 1. TYPE CHART

SECTION 20 0548
VIBRATION ISOLATION FOR MECHANICAL, PLUMBING, AND FIRE SUPPRESSION

PART 1 - GENERAL

1.1 SCOPE OF WORK

- A. Vibration isolation devices specifically applicable to Divisions 20, 21, 22, and 23, including:
 - 1. Vibration Isolators
 - a. Neoprene Pads (Type VI-1)
 - b. Neoprene Mounts (Type VI-2)
 - c. Free standing spring isolators (Type VI-3)
 - d. Restrained spring isolators (Type VI-4)
 - e. Spring hangers (Type H-3)
 - f. Pre-compressed spring hangers (Type H-4)
 - 2. Air Mounting Systems
 - a. Air springs/pneumatic isolators (Type VI-AS)
 - 3. Bases
 - a. Structural rails (Type Base-A)
 - b. Structural steel base (Type Base-B)
 - c. Steel and concrete inertia base (Type Base-C)
 - 4. Restrained Vibration Isolation Roof-Curb (Type Curb-D)
 - 5. Flexible Pipe Connectors
 - a. EPDM flexible connectors
 - b. Stainless steel hose flexible connectors
 - c. Bronze hose flexible connectors
 - 6. Vertical Pipe Riser Supports
 - a. Resilient pipe riser supports
 - b. Resilient pipe riser guides
 - 7. Horizontal Thrust Restraints

1.2 DEFINITIONS

- A. ICC-ES: ICC-Evaluation Service.
- B. Neoprene: Shock-absorbing materials compounded according to the standard for bridge-bearing neoprene as defined by AASHTO.
- C. OSHPD: Office of Statewide Health Planning and Development for the State of California

1.3 CODES AND STANDARDS (USE LATEST EDITIONS)

- A. American Society of Heating Refrigeration and Air Conditioning Engineers (ASHRAE)
 - 1. ASHRAE 2011 Applications Handbook Chapter 48, Noise and Vibration Control

- B. International Building Codes
 - 1. International Building Code (IBC)
- C. Manufacturers Standardization Society (MSS)
 - 1. MSS SP-58-02: Pipe Hangers and Supports – Materials, Design and Manufacture
- D. NSF International
 - 1. NSF/ANSI Standard 61 including Annex G: Drinking Water System Components – Health Effects
 - 2. NSF/ANSI Standard 372: Drinking Water System Components – Lead Content
- E. Occupational Safety and Health Administration (OSHA)
 - 1. 29CFR 1910.95: Occupational Noise Exposure

1.4 QUALITY ASSURANCE

- A. Testing Agency Qualifications: An independent agency, with the experience and capability to conduct the testing indicated, that is a nationally recognized testing laboratory (NRTL) as defined by OSHA in 29 CFR 1910.7, and that is acceptable to authorities having jurisdiction.
- B. Welding: Qualify procedures and personnel according to AWS D1.1/D1.1M, "Structural Welding Code – Steel."

1.5 SUBMITTALS

- A. Preconstruction – Prior to construction provide the following in accordance with Specification 20 0500 – Basic Requirements for Mechanical, Plumbing, and Fire Suppression:
 - 1. Prior to submitting product data provide a complete set of shop drawings for all equipment to receive vibration isolation from which the Vibration Isolation Manufacturer's Representative shall base the selection of vibration isolators and design of supplementary bases. The drawings shall include locations of all mechanical equipment to receive vibration isolation devices, operating weight of the equipment to be isolated and the distribution of weight to the support points. Any information regarding the components, spacing, and design approaches comprising the structural systems supporting the equipment shall also be provided to the Vibration Isolation Manufacturer's Representative.
 - 2. Product Data: For each type of product, including the following:
 - a. Manufacturer name
 - b. Isolator type and model number
 - c. Material and construction of finish
 - d. Dimensional data
 - e. Rated load, rated deflection, and overload capacity
 - f. For spring vibration isolation devices include:
 - (1) Spring diameters
 - (2) Static deflection
 - (3) Free height
 - (4) Compressed spring height and solid spring height

- g. Drawings or schedule indicating which isolators are to be used on which equipment at a particular locations
- 3. For flexible pipe connectors provide the following:
 - a. Maximum allowable temperature and pressure rating
 - b. Overall face-to-face length
 - c. Live length
 - d. Hose wall thickness, if applicable
 - e. Hose corrugations per foot and per assembly, if applicable
 - f. Fundamental frequency of assembly
 - g. Braid structure and total number of wires in braid (for stainless steel only)
- 4. Provide a complete layout of piping to be isolated, including vertical risers, showing size or weight and support points of the piping system to the vibration isolation materials manufacturer for selection and layout of isolation hangers.
- 5. Welding certificates.
- 6. Manufacturer's installation and operating manuals.
- B. Contract Closeout – At contract closeout provide the following in accordance with Specification 20 0500 – Basic Requirements for Mechanical, Plumbing, and Fire Suppression:
 - 1. Operating and Maintenance Data including:
 - a. Product data
 - b. Installation instructions
 - c. Assembly drawings
 - d. Replacement parts list
 - e. Maintenance and operation instructions
 - f. Minimum and maximum airflows
 - 2. Test Reports
 - a. Manufacturer Installation Inspection Report
 - 3. Warranties

PART 2 - PRODUCTS

2.1 VIBRATION ISOLATORS

- A. Acceptable Manufacturers
 - 1. Kinetics Noise Control
 - 2. Mason Industries
 - 3. Vibro-Acoustics
- B. General requirements applicable to all isolators:
 - 1. Outside Spring Diameter: Not less than 80% of the compressed height of the spring at rated load.
 - 2. Minimum Additional Travel Distance to Solid: 50% of the required deflection at rated load.

3. Lateral Stiffness: More than 80% of rated vertical stiffness.
 4. Overload Capacity: Support 200% of rated load, fully compressed, without deformation or failure.
 5. Operating static deflection: Refer to the Applications table in Part 3.
 6. Materials:
 - a. Indoor: Housings and springs shall be powder coated steel and hardware shall be electro-galvanized.
 - b. Outdoor: Hot dip galvanized housings and cadmium plated spring elements in compliance with ASTM A123.
 7. Springs shall be color coded to indicate load capacity.
- C. Neoprene Pads (**Type VI-1**)
1. One layer of ¾" thick neoprene pad of sufficient stiffness for uniform loading over pad area, molded with a nonslip pattern and galvanized-steel baseplates; factory cut to sizes that match requirements of supported equipment.
 2. Basis of Design: Mason Industries Type Super "W"
- D. Neoprene Mounts (**Type VI-2**)
1. Double-deflection neoprene isolator elements with factory-drilled, encapsulated top plate for bolting to equipment and with baseplate for bolting to structure. All metal surfaces shall be neoprene covered and have friction pads both top and bottom.
 2. Basis of Design: Mason Industries Type ND
- E. Free Standing Spring Isolators (**Type VI-3**)
1. Free standing, laterally stable open (without any housing)
 2. Baseplates: Bonded to ¼" thick, neoprene acoustical friction pad attached to baseplate underside. Baseplates shall limit floor load to 500 psig.
 - a. Baseplates shall be provided with bolt holes for any equipment which is to be mounted on framing or structural steel. Bolt holes are not required for equipment being mounted directly on the slab or on a concrete pad.
 3. Top Plate and Adjustment Bolt: Threaded top plate with adjustment bolt and cap screw to fasten and level equipment. Adjustment bolts shall be rigidly bolted to the equipment. Installed and operating heights shall be equal.
 4. Basis of Design: Mason Industries Type SLF (without bolt holes) or SLFH (with baseplate bolt holes)
- F. Restrained Spring Isolators (**Type VI-4**)
1. Freestanding, steel, open-spring isolators with limit-stop restraint
 2. Housing: Steel with resilient vertical-limit stops to prevent spring extension due to weight being removed; baseplate with factory drilled bolt holes for bolting to mounting surface, bonded to ¼" thick, neoprene or rubber isolator pad attached to baseplate underside; and adjustable equipment mounting and leveling bolt that acts as blocking during installation. Vertical limit stops shall be out of contact during normal operation. Horizontal clearance on the sides

between the spring assembly and the housing shall be a minimum of ½" to avoid bumping and interfering with the spring action.

3. For equipment located outside, limit stops shall resist wind velocity up to 130 mph.
4. Restraint: Limit stop as required for equipment. Restraining bolts shall have rubber grommets to provide cushioning in the vertical as well as horizontal directions. The hole through the bushing shall be a minimum of ¾" larger in diameter than the restraining bolt.
5. Basis of Design: Mason Industries Type SLR

G. Spring Hangers (**Type H-3**)

1. Hangers shall consist of rigid steel frames containing minimum 1¼" thick neoprene elements at the top and a steel spring seated in a steel washer reinforced neoprene cup on the bottom. The neoprene element and the cup shall have neoprene bushings projecting through the steel box. In order to maintain stability, the boxes shall not be articulated as clevis hangers nor the neoprene element stacked on top of the spring. Spring diameters and hanger box lower hole sizes shall be large enough to permit the hanger rod to swing through a 30° arc from side to side before contacting the cup bushing and short circuiting the spring.
 - a. Elastomeric Element: Molded, oil-resistant rubber or neoprene. Steel-washer-reinforced cup to support spring and bushing projecting through bottom of frame.
 - b. Self-centering hanger rod cap to ensure concentricity between hanger rod and support spring coil.
2. Basis of Design: Mason Industries Type 30N

H. Pre-Compressed Spring Hangers (**Type H-4**)

1. Hanger specification shall be the same as Type H-3 Spring Hangers, but they shall be pre-compressed and locked at the rated deflection by means of a resilient up-stop to keep the piping or equipment at a fixed elevation during installation. The hangers shall be designed with a release mechanism to free the spring after the installation is complete and the hanger is subjected to its full load. Deflection shall be clearly indicated by means of a scale.
2. Basis of Design: Mason Industries Type PC30N

2.2 BASES

A. Acceptable Manufacturers

1. Kinetics Noise Control
2. Mason Industries
3. Vibro-Acoustics

B. General requirements applicable to all bases:

1. Design Requirements: Lowest possible mounting height with not less than 1" clearance above the floor. Include equipment anchor bolts and auxiliary motor slide bases or rails.
2. Support Brackets: Factory-welded steel brackets on frame for outrigger isolation mountings and to provide for anchor bolts and equipment support.

C. Structural Steel Base (**Type Base-B**)

1. Factory-fabricated, welded, structural-steel base or rails

2. Structural Steel: Steel shapes, plates, and bars complying with ASTM A 36/A 36M. Bases shall have shape to accommodate supported equipment. Perimeter members shall be steel beams with minimum depth equal to $\frac{1}{10}$ of the longest dimension of the base.
 3. Basis of Design: Mason Industries Model WF
- D. Steel and Concrete Inertia Base (**Type Base-C**)
1. Factory-fabricated, welded, structural-steel bases and rails ready for placement of cast-in-place concrete.
 2. Structural Steel: Steel shapes, plates, and bars complying with ASTM A 36/A 36M. Bases shall include concrete reinforcing rebars consisting of a minimum of $\frac{1}{2}$ " bars welded in place on 6" min centers both ways in a layer 1 $\frac{1}{2}$ " above bottom. Bases shall have shape to accommodate supported equipment. Perimeter members shall be steel beams with minimum depth equal to $\frac{1}{10}$ of the longest dimension of the base.
 3. All bases shall have a minimum thickness of 6" or $\frac{1}{12}$ of the longest dimension of the base, whichever is greater.
 4. Basis of Design: Mason Industries Model K or BMK (as recommended by the isolator equipment manufacturer for specific equipment)

2.3 EPDM FLEXIBLE SPHERICAL PIPE CONNECTORS

- A. Acceptable Manufacturers
1. Mason Industries
- B. EPDM Flexible Spherical Pipe Connectors
1. Spherical pipe connectors shall consist of EPDM body and liner and Kevlar® tire cord reinforcing. The connector shall be of double sphere design with molded-in middle ring and shall allow for compression, elongation and angular movement complete with stabilizing solid steel ring embedded in EPDM body. Stabilizing steel ring shall not be flexible cable wire.
 2. Minimum compression shall be 1 $\frac{1}{4}$ " for sizes up to 6" and 1 $\frac{1}{2}$ " for larger sizes.
 3. Rated for a minimum operating pressure and temperature of 250 psi up to 170°F and 215 psi at 250°F.
 4. The connector shall be furnished with steel cables or control rods which act as control units as recommended by the manufacturer. Control rods shall incorporate neoprene washer bushings, minimum $\frac{1}{2}$ " thick, to prevent acoustical short-circuits via metal-to-metal contact.
 5. Basis of Design: Mason Industries Safeflex SFDEJ. No substitutions allowed.

2.4 STAINLESS STEEL AND BRONZE HOSE FLEXIBLE PIPE CONNECTORS

- A. Acceptable Manufacturers
1. Mason Industries
 2. Metraflex
- B. Potable Water Service
1. For potable water service, connectors shall be UL classified in accordance with NSF/ANSI 61 and NSF/ANSI 372 standards.

C. Stainless Steel Hose Flexible Pipe Connectors

1. Flexible hose shall be 304 stainless steel close pitch annular corrugated hose with a braided 304 stainless steel outer covering.
2. For pipe diameters up to 2½":
 - a. End connections shall be male carbon steel nipples with NPT threads carbon steel and shall be the minimum lengths as defined below.
 - b. Rated for a minimum operating pressure of 345 psi at up to 70°F.
 - c. The overall length shall allow for a minimum of ½" static offset, ¼" intermittent flexing, or per manufacturer's recommendations for additional motion.

PIPE DIAMETER (INCHES)	OVERALL LENGTH (INCHES)
½	10
¾	10
1	10
1¼	10
1½	12
2	14
2½	16

- d. Basis of Design: Metraflex Model SST
3. For pipe diameters 3" and larger:
 - a. End connections to be ANSI class 150 carbon steel plate flanges and shall be the minimum lengths as defined below.
 - b. Rated for a minimum operating pressure of 170 psi at up to 70°F.
 - c. The overall length shall allow for ¾" static offset and ⅜" intermittent flexing offset or, per manufacturer's recommendations, for additional motion.

PIPE DIAMETER (INCHES)	FLANGE-TO-FLANGE LENGTH (INCHES)
3	18
4	18
5	18
6	24
8	24
10	24
12	36
14	36
16	36

- d. Basis of Design: Mason Model FFL

D. Bronze Hose Flexible Connectors

1. For pipe up to 2":
 - a. Connectors shall be constructed of bronze hose and braided outer covering. End connections shall be female copper tube designed for braze connections.
 - b. Connectors shall be cleaned, de-greased, and bagged to protect from contamination.
 - c. Connectors shall be tested and approved by Underwriters Laboratories for refrigeration service.
 - d. Rated for a minimum operating pressure of 190 psi at up to 70°F.
 - e. Length shall be per manufacturer's recommendations.
 - f. Basis of Design: Metraflex Model BBS

PART 3 - EXECUTION

3.1 EXAMINATION

- A. The Contractor shall consult with the local representative of the vibration isolation materials manufacturer, prior to installing any devices, in order to obtain guidance for this project's specific installation requirements.

3.2 APPLICATION

- A. Provide vibration isolation devices for equipment per the following schedule.
 1. The base type defined below indicates that bases independent of the equipment are required; the base type is not intended to define an equipment-specific factory base. Where "none" is indicated, the equipment and its integral factory-provided base shall be mounted directly on the defined isolators.

ISOLATED EQUIPMENT			SLAB-ON-GRADE OR BASEMENT			UPPER FLOORS (SPANS UP TO 30 FT.)			COMMENT
Type	HP or Size	RPM	Base Type	Vibration Isolator		Base Type	Vibration Isolator		
				Type	Min. Defl. Rating		Type	Min. Defl. Rating	
Boilers	All	All	None	VI-1	0.5"	Base-B	VI-4	2"	
In-line Centrifugal or Axial, Cabinet Fan, Utility Sets									
Up to 22 in. diameter	All	All	None	Note 1	1"	Base-C	Note 1	1"	1. VI-3 for floor-mounted; H-3 for suspended 2. Provide horizontal thrust restraints
≥24 in. diameter	≤2 in. sp	≤300	Base-B	Note 1	3"	Base-C	Note 1	4"	
		301 to 500	Base-B	Note 1	1"	Base-C	Note 1	3"	
		≥501	Base-B	Note 1	1"	Base-B	Note 1	2"	
≥24 in. diameter	≥2.1 in. sp	≤300	Base-C	Note 1	3"	Base-C	Note 1	4"	
		301 to 500	Base-C	Note 1	2"	Base-C	Note 1	3"	
		≥501	Base-C	Note 1	1"	Base-C	Note 1	2"	

ISOLATED EQUIPMENT			SLAB-ON-GRADE OR BASEMENT			UPPER FLOORS (SPANS UP TO 30 FT.)			COMMENT
Type	HP or Size	RPM	Base Type	Vibration Isolator		Base Type	Vibration Isolator		
				Type	Min. Defl. Rating		Type	Min. Defl. Rating	
Ducted Rotating Equipment (small in-line fans, fan-powered boxes)	All	All	None	H-3	1"	None	H-3	1"	

B. Provide vibration isolation for pipe connected to any isolated equipment per the following table:

PIPE DIAMETER	LOCATION REQUIRING ISOLATED HANGERS (DISTANCE FROM EITHER SIDE OF ISOLATED EQUIPMENT)	SUSPENDED PIPE HANGER TYPE	FLOOR MOUNTED PIPE ISOLATOR TYPE	MINIMUM STATIC DEFLECTION
Up to 4"	First 3 points of support on either side of isolated equipment	H-3	VI-3	Deflection of isolated equipment (2" maximum)
5" to 8"	First 4 points of support on either side of isolated equipment	H-4	VI-4	First three points: Deflection of isolated equipment (2" maximum) Remaining point: 0.75"
10" and over	First 6 points of support on either side of isolated equipment	H-4	VI-4	First three points: Deflection of isolated equipment (2" maximum) Remaining three points: 0.75"
Over 4"	All hung piping connected to isolated equipment and located within a mechanical room with an occupied space directly above	H-4	N/A	First three points: Deflection of isolated equipment (2" maximum) Remaining point: 0.75"
Over 4"	All floor-supported piping connected to isolated equipment and located within a mechanical with an occupied space directly below	N/A	VI-4	First three points: Deflection of isolated equipment (2" maximum) Remaining point: 0.75"
Over 2"	All piping connected to isolated equipment in locations not mentioned above	H-3	VI-3	First three points: Deflection of isolated equipment (2" maximum)

3.3 INSTALLATION

A. General vibration isolation requirements:

1. The Vibration Isolator Manufacturer or the Manufacturer's Representative shall:
 - a. Supply isolators and other related equipment including rails, resilient pipe supports, fan and motor bases and structural steel forms for concrete inertia blocks wherever required.
 - b. Be responsible for proper isolator sizing to accomplish the uniform static deflection according to distribution of weight based on factory certified manufacturer's drawings of equipment to be isolated and available information regarding the existing or proposed structural design of the building.
 - c. Select springs to operate at $\frac{2}{3}$ maximum compression or provide alternate recommendation.
2. Refer to Applications Table for base type, isolator type and required deflection for each type of equipment.
3. All motor-driven mechanical equipment shall be isolated from the building structure by means of vibration isolators. If specific equipment type is not listed in the Application Table, the Contractor shall notify Engineer in writing and obtain specification from Engineer or provide vibration isolation per 2011 ASHRAE Handbook HVAC Applications Table 47.
4. No rigid connections between isolated equipment and building structure shall be made that degrades the vibration isolations systems; electrical conduit connections to isolated equipment shall be looped to allow free motion of isolated equipment. Coordinate with Electrical Contractor and Division 26 Specifications.

B. Requirements for vibration isolation of equipment with spring type vibration isolators:

1. Vibration isolators shall be of such design so that the limit stops are out of contact during normal operation. Should the isolator mounts be "driven solid" leaving no gap for normal isolator operation, the Contractor shall correct the installation by adding vibration isolation hangers to support connected pipe and/or duct or replacing the vibration isolator with a properly selected isolator.
2. For restrained spring isolators with vertical limit stops (to prevent spring extension when weight is removed), provide temporary steel spacers between the upper and lower housings. Housings shall serve as blocking during erection. When the equipment is at full operating weight, the springs shall be adjusted to assume the weight and the spacers removed without changing the installed and operating heights.
3. All equipment shall be adjusted level.

C. Requirement for bases:

1. Set structural steel bases to have 1" clearance between housekeeping pad and base.
2. Steel and Concrete Bases Fabrication: Fabricate steel templates to hold equipment anchor-bolt sleeves and anchors in place during placement of concrete. Obtain anchor-bolt templates from supported equipment manufacturer.
3. Concrete shall be 3000 psi at 28 days unless noted otherwise. Forms shall be furnished with steel templates to hold the anchor bolt sleeves and anchor bolts while concrete is being poured.

4. Inertia bases shall have frame or pouring form placed on roofing felt or plastic sheeting and filled with concrete. After the equipment is set, mounting adjustment bolts are to be used to both raise and level base to achieve proper operating height.
 5. Support pipe elbows entering and leaving pumps from the inertia base.
- D. Requirements for Horizontal Piping Vibration Isolation
1. Provide spring isolators on piping connected to equipment with vibration isolators per the Application Table above.
 2. Heat exchangers, air separators and other non-rotating equipment located in piping runs, shall be considered part of the piping system and isolated according to the requirements of the piping to which it is connected. Thus, if the associated piping adjacent to the suspended equipment requires vibration isolation, the equipment shall be isolated with the same vibration isolators used to support the pipe.
 3. Hangers shall be located as close to the overhead support steel or structural slab as practical.
 4. Piping shall pass through walls and floors without rigid connections to building structures. Penetration points shall be sleeved or otherwise formed to allow passage of piping and maintain spacing required by the UL listed wall fire suppression penetration assembly.
- E. Requirements for Vertical Piping Riser Supports
1. For all vertical risers, Contractor to provide a fully engineered riser/support isolation system to minimize deflections into the building structure. The Vibration Isolation Equipment Manufacturer Representative shall design and provide required brackets or clamps at riser spring guide and anchor locations. The Contractor to install and adjust isolators under supervision of the isolation equipment manufacturer's representative.
 2. Vertical pipe risers shall be designed to support the riser piping filled with fluid. Assigned loads must be within the building design limits at the support points. Neutral central resilient anchors close to the center of the run shall direct movement up and down.
 3. The anchors shall be capable of holding an upward force equal to the fluid weight when the system is drained. If one level cannot accommodate this force, anchors shall be located on 2 or 3 adjacent floors. Resilient guides shall be spaced and sized in accordance with the pipe diameter and insulation thickness.
 4. Vertical Pipe Risers shall be supported using Vertical Pipe Riser Resilient Supports and Resilient Pipe Guides for Vertical Pipe Risers.
- F. Requirements for ductwork isolation
1. Ductwork with working static pressures of 4" or greater and connected to isolated equipment shall be isolated with spring isolator type VI-4 (suspended) or H-4 (floor mounted) within the confines of the mechanical equipment room or within 50 ft proximity to mechanical equipment, whichever is greater.
- G. On completion of installation of all isolation materials and before start-up of isolated equipment all debris shall be cleared from areas surrounding and from beneath all isolated equipment, leaving equipment free to move on the isolation supports.

3.4 TESTING

- A. Manufacturer Installation Inspection Report - Provide report prepared by manufacturer's representative, stating that systems installed and services provided under this Section are in accordance with manufacturer's recommendations and are properly operating.

END OF SECTION

P:\22 Projects\P22-1142-00coev\04 Design\07 Specs\Div 20\20 0548-Vibration Isolation for M-P-FP.docx

SECTION 20 0553
IDENTIFICATION FOR MECHANICAL, PLUMBING, AND FIRE SUPPRESSION SYSTEMS

PART 1 - GENERAL

1.1 SCOPE OF WORK

- A. Identification of mechanical products installed under Divisions 20, 21, 22, and 23 as defined below:
 - 1. Pipe labels
 - 2. Duct labels
 - 3. Equipment labels
 - 4. Valve tags
 - 5. Labels for miscellaneous electrical for temperature controls

1.2 DEFINITIONS

- A. AHU: Air-handling unit
- B. DI: Deionized
- C. OD: Outer diameter based on pipe outside diameter; for the purpose of this specification section, the outer diameter of pipe with insulation includes the insulation.
- D. RO: Reverse osmosis
- E. TC: Temperature controls

1.3 CODES AND STANDARDS (USE LATEST EDITION)

- A. American National Standards Institute/American Society of Mechanical Engineers (ANSI/ASME)
 - 1. ANSI/ASME A13.1: Scheme for the Identification of Piping Systems.
- B. American Public Works Association (APWA)
 - 1. APWA Uniform Color Code for marking underground utility lines.
- C. ASTM International (ASTM)
 - 1. ASTM D882: Standard Test Method for Tensile Properties of Thin Plastic Sheeting
 - 2. ASTM D2103: Standard Specification for Polyethylene Film and Sheeting
 - 3. ASTM D2578: Standard Test Method for Wetting Tension of Polyethylene and Polypropylene Films
- D. International Codes
 - 1. International Mechanical Code (IMC)
- E. Underwriters Laboratories Inc. (UL)
 - 1. UL E-84-03: Standard Test Method for Surface Burning Characteristics of Building Materials.

1.4 QUALITY ASSURANCE

- A. For hydronic piping, conform to ANSI/ASME A13.1 requirements for color, length of color field and letter height.

- B. Label fire dampers, smoke dampers and combination fire/smoke dampers per IMC.
- C. Stencils shall not be used.
- D. Labels/markers listed by the manufacturer as "economy" or "value" shall not be used.

1.5 SUBMITTALS

- A. Preconstruction – Prior to construction provide the following in accordance with Division 01 and Specification 20 0500 – Basic Requirements for Mechanical, Plumbing, and Fire Suppression:
 - 1. Product Data: For each type of product indicated provide:
 - a. Manufacturer’s data including colors, materials, wording, symbols, letter size, methods of attachment and color coding for mechanical and electrical identification of piping, ductwork and equipment.
 - b. Submit manufacturer’s installation instructions.
 - c. Valve Schedule: Submit proposed valve identification for approval prior to installing valve tags. Include valve tag number, location, system served, and function.
- B. Contract Closeout – At contract closeout provide the following in accordance with Division 01 and Specification 20 0500 – Basic Requirements for Mechanical, Plumbing, and Fire Suppression:
 - 1. Valve Schedule: Provide “as-installed” valve tag schedule indicating valve tag number, location, system served, and function for Owner at completion of project.
 - 2. Warranties

PART 2 - PRODUCTS

2.1 ACCEPTABLE MANUFACTURERS

- A. Brimar Identification and Safety Products
- B. Kolbi Pipe Marker Co.
- C. Marking Services Inc. (MSI)
- D. Seton Identification and Safety

2.2 PIPE LABELS

- A. General Requirements for All Pipe Labels:
 - 1. Preprinted, color-coded, with lettering indicating service, and showing flow direction
 - 2. Pipe Label Contents:
 - a. Include identification of piping service using same designations or abbreviations as used on Drawings, pipe size, and arrows indicating flow direction.
 - b. Flow-Direction Arrows: Integral with piping system service lettering or as separate unit on each pipe label to indicate flow direction.
 - 3. Minimum marker width and lettering height shall be per the following table:

PIPE OD	MINIMUM MARKER WIDTH	MINIMUM LETTER HEIGHT
Up to 1"	8"	½"
1½" through 2¼"	8"	¾"

PIPE OD	MINIMUM MARKER WIDTH	MINIMUM LETTER HEIGHT
2 $\frac{3}{8}$ " through 7 $\frac{7}{8}$ "	12"	1 $\frac{1}{4}$ "
8" through 10"	24"	2 $\frac{1}{2}$ "
Larger than 10"	32"	3 $\frac{1}{2}$ "

B. Normal Service Coiled Pipe Labels

1. Precoiled, semi-rigid plastic formed with a service temperature range of -40°F to 160°F. Label shall be formed to partially or fully cover the circumference of pipe and to attach to pipe without adhesive.
 - a. Where required by pipe OD, provide galvanized straps for indoor applications and stainless steel straps for outdoor application for securing coiled pipe labels.
2. Basis of Design: MSI MS-970

C. Self-Adhesive Pipe Labels

1. Printed plastic with contact-type, permanent-adhesive backing used in association with flow directional arrow tape which wraps fully around the pipe.
2. Basis of Design: MS-900 with MS-900 Flow Directional Arrow Tape

D. Harsh Service Coiled Pipe Labels

1. Pre-coiled, semi-rigid laminated label applied to high density polyethylene carrier to resist damage from acids, bases and sunlight with a service temperature range of -40°F to 250°F. Label shall be formed to partially or fully cover the circumference of pipe and to attach to pipe without adhesive.
 - a. Where require by the pipe OD, provide stainless steel straps for securing coiled pipe labels. Use only with manufacturer's furnished tool for locking stainless steel straps.
2. Basis of Design: MSI MS-995 Maxilar Markers

E. Small Diameter Pipe Labels

1. Construction:
 - a. 3" x 3" labels with $\frac{1}{4}$ " high lettering designed to completely wrap around pipe.
 - b. Label shall show content and have integral flow indicating arrow.
2. Basis of Design: MS-900 TM Markers for Tubing & Small Pipe

2.3 DUCT LABELS

A. General Requirements for All Duct Labels:

1. Comply with ANSI/ASME A13.1 requirements for color, length of color field and letter height.
2. Duct Label Contents: Include identification of duct service using same designations or abbreviations as used on Drawings, duct size, and an arrow indicating flow direction.

B. Standard Duct Labels

1. Multilayer, multicolor, plastic labels for mechanical engraving and having predrilled holes for attachment hardware. Able to withstand temperatures up to 160 F. Minimum plastic label thickness shall be as follows:
 - a. $\frac{1}{16}$ " for labels up to 2" x 6"
 - b. $\frac{1}{8}$ " for labels longer than 6" or taller than 2"
2. Label Size:
 - a. For ductwork and plenums up to 12" in height, duct markers shall be a minimum of 2 $\frac{1}{4}$ " x 13".
 - b. For ductwork and plenums larger than 12" in height, duct markers shall be 4" x 24".
3. Lettering Size:
 - a. A minimum letter size of $\frac{1}{2}$ " high lettering for labels that are normally viewed from distances up to 6'.
 - b. If label must be viewed from greater than a 6' distance (e.g. duct is at a high elevation and must be viewed from the floor), the minimum text size is 1 $\frac{1}{2}$ ".
 - c. Secondary lettering shall be two-thirds to three-fourths the size of principal lettering.
4. Contact-type permanent adhesive, compatible with label and with substrate shall be utilized.
5. Basis of Design: MSI Engraved Plastic Signs

2.4 EQUIPMENT LABELS

A. General Requirements for Equipment Labels

1. Label Content: Include equipment's Drawing designation or unique equipment number.
2. Equipment Label Schedule: For each item of equipment to be labeled provide an equipment label schedule on 8 $\frac{1}{2}$ " x 11" bond paper. Tabulate equipment identification number and identify Drawing numbers where equipment is indicated (plans, details, and schedules), plus the Specification Section number and title where equipment is specified. Equipment schedule shall be included in operation and maintenance data.
3. Label Size: Length and width may vary for required label content shall not be less than 2" x 4".
4. Lettering Size: A minimum letter size of 1 $\frac{1}{2}$ " high. If label must be viewed from greater than 72" away, the minimum text size is 1 $\frac{1}{2}$ ". Secondary lettering shall be two-thirds to three-fourths the size of principal lettering.

B. Indoor Equipment Labels

1. Multilayer, multicolor, 3-ply plastic labels for mechanical engraving and having predrilled holes for attachment hardware. Able to withstand temperatures up to 160°F. Minimum plastic label thickness shall be as follows:
 - a. $\frac{1}{16}$ " for labels up to and including either a maximum area of 18 square inches or 6" in lengths.
 - b. $\frac{1}{8}$ " for labels larger than either 18 square inches in area or 6" in length.
2. Contact-type permanent adhesive, compatible with label and with substrate shall be utilized.
3. Basis of Design MSI Engraved Plastic Equipment Tags & Signs

2.5 VALVE TAGS

- A. 2" diameter or 2" square 19 gauge valve tags each marked with ¼" abbreviated service indicator on the top line and ½" numbers below (example: HTG/309).
1. Tag Material: Minimum 19 gauge (0.032") brass with predrilled or stamped holes for attachment hardware.
 2. Fasteners: Brass S-hook.

2.6 LABELS FOR MISCELLANEOUS ELECTRICAL FOR TEMPERATURE CONTROLS

- A. Self-Adhesive Pipe Labels
1. Printed plastic with contact-type, permanent-adhesive backing
 2. Black text on orange labels
 3. Basis of Design: MSI-900 Conduit and Electrical ID

PART 3 - EXECUTION

3.1 APPLICATION

- A. Piping label types shall be as follows:

APPLICATION	LABEL TYPE
Hydronic, plumbing, and fire suppression pipe less than 6" OD located indoors, except steam or condensate pipe (e.g. chilled water, condenser water, heating hot water, domestic hot water recirculation, domestic cold water, domestic hot water)	Normal service coiled pipe labels with coil-on fastening
Pipe 6" OD and larger located indoors, except steam or condensate pipe (e.g. chilled water, condenser water, heating hot water, domestic hot water recirculation, domestic cold water, domestic hot water)	Normal service coiled pipe labels with strap-on fastening or Self-adhesive pipe labels with full wrap-around tape
Specialty pipe (e.g. natural gas, compressed air, RO water, non-medical gas air and vacuum, lab gas, lab vacuum) less than 1" in diameter	Small diameter pipe labels

- B. Pipe label colors shall be as defined below; where a pipe fluid is not shown provide colors per ASME A13:

PIPE FLUID	BACKGROUND COLOR	LETTERING COLOR
Cold water systems including, but not limited to, chilled, condenser, domestic cold, and RO water.	Green	White
Hot water system including, but not limited to, heating hot water and domestic hot water	Yellow	Black
Fire-quenching fluids including fire sprinkler water	Red	White
Natural gas and other flammable liquids	Yellow	Black

C. Duct label colors shall be as follows:

DUCT AIR TYPE	BACKGROUND COLOR	LETTERING COLOR
Supply air	Blue	White
Outside, return and relief air	Green	White
Exhaust air (all types)	Yellow	Black

3.2 INSTALLATION

A. General Installation Requirements

1. Clean piping and equipment surfaces of substances that could impair bond of identification devices, including dirt, oil, grease, release agents, and incompatible primers, paints, and encapsulants.
2. Install marking in accordance with manufacturer's installation instructions.
3. Install identification prior to installation of acoustic ceiling and similar removable concealment.
4. Provide custom pipe and duct labels when standard labels meeting the requirements of this specification are not available.

B. Additional Requirements for Pipe Labels

1. Install pipe labels on all Divisions 20, 21, 22, and 23 pipe shown on drawings. Contractor shall coordinate between piping systems so that each pipe system is labeled with a distinct name.
 - a. Labeled pipes include, but are not necessarily limited to, chilled water supply/return, condenser water supply/return, heating hot water supply/return, steam, condensate return, boiler feed, domestic cold water, domestic hot water, domestic hot water recirculation, tempered water, medical air, medical vacuum, oxygen, lab air, lab vacuum, sprinkler, fire main, acid waste and acid vent.
2. Labels shall indicate pipe content as shown on drawings (e.g. REHEAT HOT WATER SUPPLY, CHILLED WATER SUPPLY) and direction of fluid flow. For steam and condensate less than 100 lb operating pressure, indicate "LOW PRESSURE STEAM" or "MEDIUM PRESSURE STEAM" as indicated on drawings. For steam and condensate operating at 100 lbs or greater, labels shall indicate the system working pressure (e.g.130 LB STEAM).
3. Install pipe labels after application of insulation and/or final painting.
4. Label all piping, both exposed and concealed, including piping located in accessible maintenance spaces such as shafts, tunnels, and plenums. Locate labels as follows:
 - a. Near each valve and control device.
 - b. Near each branch connection, excluding short takeoffs for fixtures and terminal units. Where flow pattern is not obvious, mark each pipe at branch.
 - c. Near penetrations through walls, floors, ceilings, and inaccessible enclosures.
 - d. At access doors, manholes, and similar access points that permit view of concealed piping.
 - e. Near major equipment items and other points of origination and termination.
 - f. Space at maximum intervals of 25 feet along each straight portion of pipe. Each straight run must have an individual label regardless of its length.

5. Install in clear view and align with axis of piping.
6. Where self-adhesive pipe labels are allowed, wrap each end of the pipe labels with directional tape. Directional tape shall be wrapped circumferentially completely around pipe at both ends of the pipe marking label. Arrow tape color shall match marker color.
 - a. Tape shall be 1" wide on piping up to and including 10" OD and 2" wide on piping larger than 10" OD.

C. Additional Requirements for Duct Labels

1. Duct labels shall indicate the air handling equipment serving the duct and the area served (e.g. "AHU-7 3RD FLOOR SUPPLY AIR, EF-3 KITCHEN EXHAUST", etc.).
2. Label ductwork at the following locations:
 - a. In each space where ducts are exposed or concealed by removable ceiling system at maximum intervals of 50 feet
 - b. Entering and leaving an air handling unit
 - c. Entering and leaving any supply, return or exhaust fan
 - d. At each side of a penetration of structure or enclosure
3. At each duct access door located in ductwork or housings, provide label indicating purpose of access (to what equipment) and other maintenance and operating instructions and appropriate safety and procedural information.
 - a. Where access doors are concealed, such as above acoustical ceilings, provide secondary plasticized tags in visible locations if desired and acceptable to the Owner.

D. Additional Requirements for Equipment Labels

1. Provide labeling for all mechanical and plumbing equipment including but not limited to the equipment defined below. Equipment label text shall provide the name and number of the identified equipment, as well as the system or location which the equipment serves. Indicate when equipment is stand-by. Examples of the required text is given below:
 - a. AHUs: (e.g. AHU-1, air handling unit serving 1st floor west)
 - b. Fans: (e.g. TE-1, toilet exhaust for lobby toilets)
 - c. Chillers: (CH-1 Chiller for main chiller plant)
 - d. Boilers: (B-1, stand-by boiler for main boiler plant)
 - e. Pumps: (P-1, heating hot water pump)
 - f. Variable frequency drives: (VFD-1, VFD for AHU-1 supply fan)
 - g. Heat exchangers: (HX-1 heat exchanger for reheat hot water loop)
 - h. Tanks and pressure vessels
 - i. Humidifiers
 - j. Water treatment equipment
 - k. Temperature control panels and other major control equipment
2. Confirm equipment numbering scheme with Owner; provide different numbering scheme than that shown on drawings if required by Owner. If Owner has no preference, number as shown on drawings.

E. Additional Requirements for Valves Tags

1. Customize tags in accordance with system. Coordinate the valve system numbering sequence with the Owner.
2. Install tags on all valves and control devices located in main and branch piping systems.
 - a. Exceptions: Check valves, convenience and lawn-watering hose connections. List tagged valves in a valve schedule. Identify valves in main and branch piping with tags.
3. Secure tags to valves in visible position using brass jack or bead chain.
4. Provide valve chart and schedule at completion of project. Provide in aluminum frame with clear plastic shield, and install at Owner-directed location.

F. Additional Requirements for Labels for Miscellaneous Electrical for Temperature Controls

1. Identify temperature control conduit and electrical conduit installed as part of the temperature control work.

END OF SECTION

P:\22 Projects\P22-1142-00coev\04 Design\07 Specs\Div 20\20 0553-Identification for M-P-FP.docx

SECTION 20 0700
THERMAL INSULATION FOR MECHANICAL, PLUMBING AND FIRE SUPPRESSION

PART 1 - GENERAL

1.1 SCOPE OF WORK

- A. Products furnished and installed under this section:
 - 1. Pipe insulation
 - 2. Pipe insulation jackets
 - 3. Duct and equipment insulation
 - 4. Duct and equipment insulation jackets
 - 5. Insulation accessories
- B. Repairs to all existing insulation cut or damaged by work performed under this Contract.

1.2 DEFINITIONS

- A. ASJ: All Service Jacket (no outer film)
- B. ASJ+: All Service Jacket with an outer film layer leaving no paper exposed.
- C. Concealed Applications: Insulation on ductwork, piping or equipment that is located in a concealed area not visible to the building occupants such as behind walls and above ceilings.
- D. Ductwork Insulation: Thermal insulation applied to limit or reduce heat transmission to or from a duct system.
- E. EPA: Environmental Protection Agency.
- F. Equipment Insulation: Thermal insulation applied to limit or reduce heat transmission to or from a piece of equipment that is part of a plumbing, heating or cooling system.
- G. Exposed Applications: Insulation on ductwork, piping or equipment that is located in an area such that is visible by the building occupants such as within a mechanical room or located in a space where there is no ceiling and all ductwork and piping is exposed.
- H. FSK: Foil Scrim Kraft; jacketing
- I. Insert: Spacer placed between the equipment support system and the equipment to allow for the space required for insulation.
- J. Insulation Shield: Buffer material placed between the equipment support system and the insulation to prevent the insulation material from being crushed.
- K. Jacket: Protective covering over insulation; may be factory-applied or field-applied to provide additional protection; of such materials as canvas, polyvinyl chloride (PVC), aluminum or stainless steel.
- L. Piping Insulation: Thermal insulation applied to limit or reduce heat transmission to or from a piping system.
- M. PSK: Poly Scrim Kraft; jacketing
- N. PVC: PolyVinyl Chloride
- O. SSL: Self-Sealing Lap

- P. SSL+: Self-Sealing Lap with Advanced Closure System
- Q. Thermal Conductivity (K value): Units of Btu-inch/hour per square foot per °F.
- R. Vapor Retarder Jacket: Insulation jacket material which impedes the transmission of water vapor.
- S. WHO: World Health Organization

1.3 CODES AND STANDARDS (USE LATEST EDITION)

- A. ASTM International (ASTM)
 - 1. ASTM A167: Standard Specification for Stainless and Heat-Resisting Chromium-Nickel Steel Plate, Sheet, and Strip.
 - 2. ASTM A240: Specification for Chromium and Chromium-Nickel Stainless Steel Plate, Sheet, and Strip for Pressure Vessels and for General Applications
 - 3. ASTM B209: Standard Specification for Aluminum and Aluminum-Alloy Sheet and Plate (ASTM B209M - Standard Specification for Aluminum and Aluminum-Alloy Sheet and Plate).
 - 4. ASTM C177: Standard Test Method for Steady-State Heat Flux Measurements and Thermal Transmission Properties by Means of the Guarded Hot Plate Apparatus.
 - 5. ASTM C195: Standard Specification for Mineral Fiber Thermal Insulating Cement.
 - 6. ASTM C196: Specification for Expanded or Exfoliated Vermiculite Thermal Insulating Cement.
 - 7. ASTM C335: Standard Test Method for Steady-State Heat Transfer Properties of Pipe Insulation
 - 8. ASTM C449: Standard Specification for Mineral Fiber Hydraulic-Setting Thermal Insulating and Finishing Cement.
 - 9. ASTM C450: Practice for Fabrication of Thermal Insulation Fitting Covers for NPS Piping, and Vessel Lagging
 - 10. ASTM C518: Standard Test Method for Steady-State Heat Flux Measurements and Thermal Transmission Properties by Means of the Heat Flow Meter Apparatus.
 - 11. ASTM C534: Standard Specification for Preformed Flexible Elastomeric Cellular Thermal Insulation in Sheet and Tubular Form.
 - 12. ASTM C547: Standard Specification for Mineral Fiber Preformed Pipe Insulation.
 - 13. ASTM C552: Specification for Cellular Glass Thermal Insulation.
 - 14. ASTM C553: Mineral Fiber Blanket and Felt Insulation (Industrial Type).
 - 15. ASTM C585: Practice for Inner and Outer Diameters of Rigid Thermal Insulation for Nominal Sizes of Pipe and Tubing (NPS System).
 - 16. ASTM C612: Mineral Fiber Block and Board Thermal Insulation.
 - 17. ASTM C795: Standard Specification for Thermal Insulation for Use in Contact with Austenitic Stainless Steel.
 - 18. ASTM C871: Test Methods for Chemical Analysis of Thermal Insulation Materials for Leachable Chloride, Fluoride, Silicate, and Sodium Ions.
 - 19. ASTM C921: Practice for Determining the Properties of Jacketing Materials for Thermal Insulation.

20. ASTM C1136: Specification for Flexible, Low Permeance Vapor Retarders for Thermal Insulation.
 21. ASTM C1290: Specification for Flexible Fibrous Glass Blanket Insulation Used to Externally Insulate HVAC Ducts.
 22. ASTM C1393: Specification for Perpendicularly Oriented Mineral Fiber Roll and Sheet Thermal Insulation for Pipes and Tanks.
 23. ASTM D1644: Test Methods for Nonvolatile Content of Varnishes.
 24. ASTM D1784: Standard Specification for Rigid Poly (Vinyl Chloride) (PVC) Compounds and Chlorinated Poly (Vinyl Chloride) (CPVC) Compounds.
 25. ASTM E84: Standard Test Method for Surface Burning Characteristics of Building Materials.
 26. ASTM E96: Standard Test Methods for Water Vapor Transmission of Materials.
 27. ASTM F249: Test Method for Water Vapor Transmission Rate Through Plastic Film and Sheeting Using a Modulated Infrared Sensor.
- B. ASHRAE
1. ASHRAE Standard 90.1: Energy Standard for Buildings Except Low-Rise Residential Buildings.
- C. Code of Federal Regulations
1. 40 CFR - Protection of Environment, Chapter I - Environmental Protection Agency, Part 59 - "National Volatile Organic Compound Emission Standards for Consumer and Commercial Products," Subpart D - "National Volatile Organic Compound Emission Standards for Architectural Coatings."
- D. Midwest Insulation Contractors Association (MICA)
1. MICA: Commercial and Industrial Insulation Standards.
- E. Military Specifications
1. MIL-A-24179A: Adhesive, Flexible Unicellular-Plastic Thermal Insulation
 2. MIL-A-3316C: Adhesives, Fire-Resistant, Thermal Insulation
 3. MIL-C-20079H: Cloth, Glass; Tape, Textile Glass and Thread, Glass and Wire-Reinforced Glass
 4. MIL-PRF-19565C: Coating Compounds, Thermal Insulation, Fire- and Water-Resistant, Vapor Barrier
 5. MIL+PRF-22344E (except pH requirements): Military Specification: insulation, Pipe, Thermal
 6. MIL+24244D: Insulation Material with Special Corrosion, Chloride and Fluoride Requirements
- F. National Fire Protection Association (NFPA)
1. NFPA-90A: Installation of Air Conditioning and Ventilation Systems.
 2. NFPA-90B: Warm Air Heating and Air-Conditioning Systems.
 3. NFPA 255: Standard Method of Test of Surface Burning Characteristics of Building Materials.
- G. North American Insulation Manufacturers Association (NAIMA)
1. NAIMA: National Insulation Standards.
- H. Underwriters Laboratories Inc. (UL)
1. UL 723: Standard for Test for Surface Burning Characteristics of Building Materials.

2. Underwriter's Laboratories Environmental (UL Environment)

1.4 QUALITY ASSURANCE

- A. Installer Qualifications: Company specializing in performing the work of this section with minimum five years documented experience utilizing skilled mechanics who have successfully completed an apprenticeship program or another craft training program certified by the Department of Labor, Bureau of Apprenticeship and Training.
- B. Surface-Burning Characteristics: For insulation and related materials, UL/ULC Classified per UL 723 as determined by UL testing. Factory label insulation and jacket materials and adhesive, mastic, tapes, and cement material containers, with appropriate markings of applicable testing agency.
 - 1. Insulation Installed Indoors and Outdoors: Flame-spread index of 25 or less, and smoke-developed index of 50 or less.
- C. Manufacturer's Qualifications: Company specializing in manufacturing the Products specified in this section with minimum five years documented experience.
- D. Insulation thickness shall be per Part 3 of this specification or as required by the latest edition of ASHRAE Standard 90.1 and the applicable energy code(s), whichever is greater.
- E. Low Emitting Materials: For all thermal and acoustical applications of Glass Wool Insulation Products, provide materials complying with the testing and products requirements of UL GREENGUARD Gold Certification.
- F. Products shall not contain asbestos, lead, mercury, or mercury compounds.
- G. Products that come in contact with stainless steel shall have a leachable chloride content of less than 50 ppm when tested according to ASTM C871.
- H. Insulation materials for use on austenitic stainless steel shall be qualified as acceptable according to ASTM C795.
- I. Foam insulation materials shall not use CFC or HCFC blowing agents in the manufacturing process.
- J. No insulation product shall support or promote mold or fungus growth.

1.5 SUBMITTALS

- A. Preconstruction – Prior to construction provide the following in accordance with Division 01 and Specification 20 0500 – Basic Requirements for Mechanical, Plumbing, and Fire Suppression:
 - 1. Product Data: Provide a schedule, listing each type of insulation, thickness, density, type of protective covering, etc., and the work and service to which each type of insulation is to be applied. The schedule shall be submitted in quantities consistent with that required in the Conditions of the Contract. No insulation shall be purchased or installed until the schedule is reviewed by the Engineer.
 - 2. Manufacturer's Installation Instructions: Indicate specific installation instructions per the manufacturers of the various products and indicate how the system (combination of products) will be assembled. Highlight critical environmental factors such as drying time, etc., as well as any variations between the manufacturer's installation instructions and the specified installation instructions along with a reason for the difference.
 - 3. Manufacturer's Certificate: Certify that products meet or exceed specified requirements.

B. Contract Closeout – At contract closeout provide the following in accordance with Division 01 and Specification 20 0500 – Basic Requirements for Mechanical, Plumbing, and Fire Suppression:

1. Test Reports
 - a. Insulation Inspection Test
2. Warranties

1.6 DELIVERY, STORAGE AND HANDLING

- A. Packaging: Insulation material containers shall be marked by manufacturer with appropriate ASTM standard designation, type and grade, and maximum use temperature.
- B. Protect products against dirt, water, chemical and mechanical damage before, during and after installation. Do not install damaged or wet insulation; remove from project site. Damage to products prior to final acceptance of the Work shall be repaired or replaced at no additional cost to Owner.
- C. Maintain ambient conditions required by the manufacturer of each product.

PART 2 - PRODUCTS

2.1 PIPE INSULATION

- A. **Type GWP:** Glass Wool Preformed Pipe Insulation
 1. Acceptable Manufacturers and Products
 - a. Basis of Design: Knauf Insulation; Earthwool 1000-Degree Pipe Insulation with ASJ+ jacket with SSL+ with advanced closure system
 - b. Johns Manville; Micro-Lok
 - c. Manson Insulation; Alley- K
 - d. Owens Corning; Fiberglas Pipe Insulation
 2. Glass wool bonded with a sustainable bio-based thermosetting conductivity resin. Comply with Comply with ASTM C585, ASTM C411, ASTM C795, and ASTM C547, Type I, Grade A, for use up to 850F. Product shall contain a minimum of 50% post-consumer recovered and recycled materials. Mineral or glass insulation products shall be GreenGuard Certified for low VOC emissions.
 3. Thermal ('k' value) per ASTM C335 of:
 - a. 0.23 Btu in/hr ft² °F or less at 75°F mean temperature
 - b. 0.29 Btu in/hr ft² °F or less at 200°F mean temperature
 - c. 0.43 Btu in/hr ft² °F or less at 400°F mean temperature
 4. With factory-applied ASJ+ jacket with SSL+: All service jacket with outer film - self-sealing advance closure system
 - a. Factory applied white All Service Jacket composed of aluminum foil reinforced with glass scrim bonded to a kraft paper interleaving with an outer film leaving no paper exposed; complying with ASTM C 1136 Type I, II, III, IV and VII.
 - b. Integral self-sealing positive closure longitudinal laps and matching ASJ+ butt strips. Jacket shall be sealed without the use of tools, staples, adhesives, ties or tape. Vapor permeability shall not exceed .02 perms.

2.2 PIPE INSULATION JACKETS – FIELD APPLIED

- A. **Type PVC:** PVC Jacket
1. Acceptable Manufacturers and products:
 - a. Johns Manville; Zeston
 - b. Proto Corporation
 - c. Speedline
 2. High-impact-resistant, UV-resistant PVC complying with ASTM D1784, Class 16354-C; stock ready for shop or field cutting and forming.
 3. Thickness
 - a. 20 mils for indoor applications
 - b. 30 mils for outdoor applications
 4. Adhesive: As recommended by jacket material manufacturer.
 5. Color: White
 6. Fitting covers: Provide factory-fabricated fitting covers to match jacket.

2.3 DUCT AND EQUIPMENT INSULATION

- A. **Type MF-FB:** Mineral or Glass Fiber Flexible Blanket Insulation
1. Acceptable Manufacturers and Products
 - a. Basis of Design: Knauf Insulation; Atmosphere Duct Wrap
 - b. Johns Manville; Microlite EQ
 - c. Owens Corning; SoftR Duct Wrap
 2. Mineral or glass fibers bonded with a sustainable bio-based thermosetting resin. Comply with ASTM C553, Types I, II and III and ASTM C 1290 Types I, II and III; for use to 250F. Density: $\frac{3}{4}$ lb/ft³ minimum. Increase density if required to meet specified 'k' value.
 3. Thermal conductivity (k-value) of 0.29 Btu in/ hr ft² F or less at 75°F mean temperature per ASTM C518.
 4. Jacket: Factory applied type FSK.
- B. **Type MF-RB:** Mineral or Glass Fiber Rigid Board Insulation
1. Acceptable Manufacturers and Products
 - a. Basis of Design: Knauf Insulation; Earthwool Insulation Board
 - b. Johns Manville; 800 Series Spin-Glas
 - c. Manson Insulation; AK Board
 2. Mineral or glass fibers bonded with a thermosetting resin. Comply with ASTM C612, Type IA or IB; for use up to 450°F. Density: 3 lb/ft³ minimum. Increase density if required to meet specified 'k' value.
 3. Thermal conductivity (k-value) of 0.23 Btu in/ hr ft² °F or less at 75°F mean temperature per ASTM C518 and C177.
 4. Jacket: Factory applied type FSK.

C. **Type MF-SRB:** Mineral or Glass Fiber Semi-Rigid Board Pipe and Tank Insulation

1. Acceptable Manufacturers and Products
 - a. Basis of Design: Knauf Insulation; Earthwool Pipe and Tank Insulation
 - b. Johns Manville
 - c. Manson Insulation
 - d. Owens Corning
2. Mineral or glass fibers bonded with a sustainable bio-based thermosetting resin. Comply with ASTM C1393, Type II or IIIA, for use up to 850°F.
3. Thermal conductivity (k-value) of 0.26 Btu in/ hr ft² °F or less at 100°F mean temperature per ASTM C177.
4. Compressive strength 120 PSF or greater @ 10% deformation per ASTM C165.
5. Product to contain a minimum 50% recycled content.
6. Factory-applied ASJ jacket.

2.4 DUCT AND EQUIPMENT INSULATION JACKETS

A. Factory-Applied Insulation Jackets

1. **Type ASJ:** All Service Jacket
 - a. Factory applied white, kraft-paper, fiberglass-reinforced scrim with aluminum-foil backing and self-sealing longitudinal lap, pressure sensitive, acrylic-based adhesive covered by a removable protective strip. Comply with ASTM C1136, Type I. Vapor permeability shall not exceed .02 perms.
2. **TYPE ASJ+SSL+:** All Service Jacket with Advanced Closure System self-sealing lap
 - a. All Service Jacket composed of aluminum foil reinforced with glass scrim bonded to a kraft paper interleaving with an outer film leaving no paper exposed; complying with ASTM C 1136 Type I, II, III, IV and VII. Vapor retarder; with a self-sealing adhesive and matching ASJ+ butt strips. Vapor permeability shall not exceed .02 perms.
3. **Type FSK:** Foil Scrim Kraft jacket
 - a. Factory applied aluminum-foil, fiberglass-reinforced scrim with kraft-paper backing. Comply with ASTM C1136, Type I. Vapor permeability shall not exceed .02 perms.
4. **Type PSK:** Polypropylene Scrim Kraft jacket
 - a. Aluminum-foil, fiberglass-reinforced scrim with polyethylene backing. Complying with ASTM C 1136, Type II, white, conforming to ASTM C 1136 Type 1. Vapor permeability shall not exceed .02 perms.

B. Field-Applied Insulation Jackets:

1. **Type PVC:** PVC jacket
 - a. Acceptable Manufacturers and products:
 - (1) Johns Manville; Zeston
 - (2) P.I.C. Plastics
 - (3) Proto Corporation
 - (4) Speedline

- b. High-impact-resistant, UV-resistant PVC complying with ASTM D1784, Class 16354-C; stock ready for shop or field cutting and forming.
- c. Thickness
 - (1) 20 mils for indoor applications
 - (2) 0 mils for outdoor applications
- d. Adhesive: As recommended by jacket material manufacturer.
- e. PVC Corner Angles: 30 mils thick, minimum 1 by 1 inch, PVC according to ASTM D1784, Class 16354-C.
- f. Color: White

2.5 INSULATION ACCESSORIES

A. Adhesives and Insulating Cements

1. Acceptable Manufacturers:
 - a. Foster
 - b. Minnesota Mining
 - c. Chicago Mastic
2. Adhesives and insulating cements shall meet the following requirements:
 - a. Mineral-Fiber Insulating Cement: Comply with ASTM C195;
 - b. Mineral-Fiber, Hydraulic-Setting Insulating and Finishing Cement: Comply with ASTM C449
 - c. Mineral-Fiber Adhesive: Comply with MIL-A-3316C, Class 2, Grade A.
 - d. Cellular-Glass Adhesive: Two-component, thermosetting urethane adhesive containing no flammable solvents, with a service temperature range of minus 100F - 200F
 - e. Flexible Elastomeric and Polyolefin Adhesive: Comply with MIL-A-24179A, Type II, Class I.
 - f. ASJ Adhesive Jacket Adhesive: Comply with MIL-A-3316C, Class 2, Grade A for bonding insulation jacket lap seams and joints.
 - g. PVC Jacket Adhesive: Compatible with PVC jacket.
3. For indoor applications, adhesive and insulating cement shall have a VOC content of 50 g/L or less when calculated according to 40 CFR 59, Subpart D (EPA Method 24). Exception: Mineral-Fiber Adhesive shall have a VOC content of 80 g/L or less.
4. Adhesives and insulating cements shall be compatible with insulation materials, jackets, and substrates and for bonding insulation to itself and to surfaces to be insulated unless otherwise indicated.

B. Sealants

1. For indoor applications, sealants shall have a VOC content of 420 g/L or less when calculated according to 40 CFR 59, Subpart D (EPA Method 24).
2. Materials shall be compatible with insulation materials, jackets, and substrates.
3. Joint Sealants:
 - a. Fire and water resistant permanently flexible, elastomeric sealant.
 - b. Service Temperature Range: Minus 100°F - 300°F
 - c. Color: White or gray.
 - d. Elastomeric: Permanently flexible.

- e. Cellular Glass: Two-component, thermosetting urethane adhesive containing no flammable solvents, with a service temperature range of minus 100°F - 200°F. Materials in first paragraph below are for sealing metal jacket seams and joints.
4. FSK and Metal Jacket Flashing Sealants:
 - a. Fire- and water-resistant, flexible, elastomeric sealant.
 - b. Service Temperature Range: Minus 40°F - 250°F.
 - c. Color: Aluminum.
 5. ASJ Flashing Sealants, and Vinyl, PVDC, and PVC Jacket Flashing Sealants:
 - a. Fire- and water-resistant, flexible, elastomeric sealant.
 - b. Service Temperature Range: Minus 40°F - 250°F.
 - c. Color: White.
- C. Mastics
1. Materials shall be compatible with insulation materials, jackets, and substrates; comply with MIL-PRF-19565C, Type II.
 2. For indoor applications, use mastics that have a VOC content of 50 g/L or less when calculated according to 40 CFR 59, Subpart D (EPA Method 24).
 3. Vapor-Barrier Mastic, Indoor: Water based; suitable for indoor use on below-ambient services.
 - a. Water-Vapor Permeance: ASTM F 1249, 0.08 perm at 37-mil dry film thickness.
 - b. Service Temperature Range: Minus 20°F - 180°F.
 - c. Solids Content: ASTM D1644, 58% by volume and 70% by weight.
 - d. Color: White.
 4. Vapor-Barrier Mastic, Outdoor: Water based; suitable for outdoor use on below-ambient services.
 - a. Water-Vapor Permeance: ASTM F1249, 1.8 perm at 30-mil dry film thickness.
 - b. Service Temperature Range: Minus 20°F - 180°F.
 - c. Solids Content: ASTM D1644, 60% by volume and 66% by weight.
 - d. Color: White.
- D. Tapes
1. ASJ Tape: White vapor-retarder tape matching factory-applied jacket with acrylic adhesive, complying with ASTM C1136.
 - a. Width: 3 inches.
 - b. Thickness: 11.5 mils.
 - c. Adhesion: 90 ounces force/inch in width.
 - d. Elongation: 2%.
 - e. Tensile Strength: 40 lbf/inch in width.
 2. PVC Tape: White vapor-retarder tape matching field-applied PVC jacket with acrylic adhesive; suitable for indoor and outdoor applications.
 - a. Width: 2 inches.
 - b. Thickness: 6 mils.
 - c. Adhesion: 64 ounces force/inch in width.

- d. Elongation: 500%.
 - e. Tensile Strength: 18 lbf/inch in width.
3. FSK Tape: Foil-face, vapor-retarder tape matching factory-applied jacket with acrylic adhesive; complying with ASTM C1136.
 - a. Width: 3 inches.
 - b. Thickness: 6.5 mils.
 - c. Adhesion: 90 ounces force/inch in width.
 - d. Elongation: 2%.
 - e. Tensile Strength: 40 lbf/inch in width.
 4. Aluminum-Foil Tape: Foil face vapor-retarder tape with acrylic adhesive.
 - a. Width: 2 inches
 - b. Thickness: 3.7 mils.
 - c. Adhesion: 100 ounces force/inch in width.
 - d. Elongation: 5%.
 - e. Tensile Strength: 34 lbf/inch in width.
- E. Securements
1. Stainless Steel Bands: ASTM A167 or ASTM A240, Type 304; 0.015 inch thick, ½-inch wide with wing seal. Provide closed seal when strapping on tanks or vessels with diameter greater than or equal to 8 feet.
 2. Aluminum Bands: ASTM B209, Alloy 3003, 3005, 3105, or 5005; Temper H-14, 0.020-inch thick, ½-inch wide with wing seal. Provide closed seal when strapping on tanks or vessels with diameter greater than or equal to 8 feet.
 3. Band Springs: Twin spring set constructed of stainless steel with ends flat and slotted to accept metal bands. Spring size determined by manufacturer for application.
 4. Staples: Outward-clinching insulation staples, nominal ¾-inch wide, stainless steel or Monel.
 5. Wire: 16 gauge annealed galvanized steel.
 6. Insulation Pins and Hangers:
 - a. Capacitor-Discharge-Weld Pins: Zinc-coated steel pin, fully annealed for capacitor-discharge welding, 0.106" diameter shank, length to suit depth of insulation indicated.
 - b. Cupped-Head, Capacitor-Discharge-Weld Pins: Zinc-coated steel pin, fully annealed for capacitor-discharge welding, 0.106" diameter shank, length to suit depth of insulation indicated with integral 1½" galvanized carbon-steel washer.
 - c. Metal, Adhesively Attached, Perforated-Base Insulation Hangers: Baseplate welded to projecting spindle that is capable of holding insulation, of thickness indicated, securely in position indicated when self-locking washer is in place. Comply with the following requirements:
 - (1) Baseplate: Perforated, galvanized carbon-steel sheet, 0.030" thick by 2" square.
 - (2) Spindle: Zinc-coated, low-carbon steel or Aluminum, fully annealed, 0.106" diameter shank, length to suit depth of insulation indicated.

- (3) Adhesive: Recommended by hanger manufacturer. Product with demonstrated capability to bond insulation hanger securely to substrates indicated without damaging insulation, hangers, and substrates.
- d. Insulation-Retaining Washers: Self-locking washers formed from 0.016" thick, galvanized-steel or aluminum sheet, with beveled edge sized as required to hold insulation securely in place but not less than 1½" in diameter.

PART 3 - EXECUTION

3.1 EXAMINATION

- A. Examine for possible asbestos-containing insulation and notify Owner. Do not remove insulation thought to contain asbestos.
- B. Examine substrates and conditions for compliance with requirements for installation tolerances and other conditions affecting performance of insulation application.
- C. Verify that systems to be insulated have been tested and are free of defects.
- D. Verify that surfaces to be insulated are clean and dry.
- E. Proceed with installation only after unsatisfactory conditions have been corrected.
- F. Install products only after piping, ductwork and equipment have been pressure testing and the pressure testing approved by the Engineer.
- G. Provide drop cloths or other means of protecting all equipment from drops, spattering, etc. which may be caused by the application of insulating products.

3.2 GENERAL INSTALLATION REQUIREMENTS

- A. Insulate all cold surfaces that can condense and all warm surfaces 105°F or higher. This includes, but is not limited to, surfaces supplied as part of a manufacturer's packaged equipment assembly.
- B. Install products in accordance with manufacturer's and NAIMA instructions.
- C. Surface Preparation: Clean and dry surfaces to receive insulation. Remove materials that will adversely affect insulation application.
- D. Install insulation materials, accessories, and finishes with smooth, straight, and even surfaces; free of voids throughout the length of piping including fittings, valves, and specialties.
- E. Install insulation materials, forms, vapor barriers or retarders, jackets, and thicknesses required for each item of pipe system as specified in insulation system schedules.
- F. Install accessories compatible with insulation materials and suitable for the service. Install accessories that do not corrode, soften, or otherwise attack insulation or jacket in either wet or dry state.
- G. Install insulation with longitudinal seams at top and bottom of horizontal runs.
- H. Install multiple layers of insulation with longitudinal and end seams staggered.
- I. Keep insulation materials dry during application and finishing.
- J. Do not weld brackets, clips, or other attachment devices to piping, fittings, and specialties.
- K. Install insulation with tight longitudinal seams and end joints. Bond seams and joints with adhesive recommended by insulation material manufacturer.

- L. Install insulation with least number of joints practical.
- M. Where vapor barrier is indicated, seal joints, seams, and penetrations in insulation at hangers, supports, anchors, and other projections with vapor-barrier mastic.
 - 1. Install insulation continuously through hangers and around anchor attachments.
 - 2. For insulation application where vapor barriers are indicated, extend insulation on anchor legs from point of attachment to supported item to point of attachment to structure. Taper and seal ends at attachment to structure with vapor-barrier mastic.
 - 3. Install insert materials and install insulation to tightly join the insert. Seal insulation to insulation inserts with adhesive or sealing compound recommended by insulation material manufacturer.
 - 4. Cover inserts with jacket material matching adjacent pipe insulation. Install shields over jacket, arranged to protect jacket from tear or puncture by hanger, support, and shield.
 - 5. Duct mounted sensors and other devices to be installed on the outside of the insulation. Seal and provide complete vapor barrier at any penetrations of the insulation.
- N. Apply adhesives, mastics, and sealants at manufacturer's recommended coverage rate and wet and dry film thicknesses.
- O. Mix insulating cements with clean potable water; if insulating cements are to be in contact with stainless-steel surfaces, use demineralized water.
- P. Install insulation with factory-applied jackets as follows:
 - 1. Draw jacket tight and smooth.
 - 2. Cover circumferential joints with 3" wide strips, of same material as insulation jacket. Secure strips with adhesive and outward clinching staples along both edges of strip, spaced 4" o.c.
 - 3. Overlap jacket longitudinal seams at least 1½". Install insulation with longitudinal seams at bottom of pipe. Clean and dry surface to receive self-sealing lap. Staple laps with outward clinching staples along edge at 2" o.c.
 - 4. For below-ambient services, apply vapor-barrier mastic over staples.
 - 5. Cover joints and seams with tape, according to insulation material manufacturer's written instructions, to maintain vapor seal.
 - 6. Where vapor barriers are indicated, apply vapor-barrier mastic on seams and joints and at ends adjacent to pipe flanges and fittings.
- Q. Cut insulation in a manner to avoid compressing insulation more than 75% of its nominal thickness.
- R. Finish installation with systems at operating conditions. Repair joint separations and cracking due to thermal movement.
- S. Repair damaged insulation facings by applying same facing material over damaged areas. Extend patches at least 4" beyond damaged areas. Adhere, staple, and seal patches similar to butt joints.
- T. Where existing insulation has been removed or disturbed, due to new connections and/or alterations, repair and replace existing insulation per the requirements of this specification.

U. Penetrations:

1. Insulation Installation at Roof Penetrations: Install insulation continuously through roof penetrations.
 - a. Seal penetrations with flashing sealant.
 - b. For applications requiring only indoor insulation, terminate insulation above roof surface and seal with joint sealant. For applications requiring indoor and outdoor insulation, install insulation for outdoor applications tightly joined to indoor insulation ends. Seal joint with joint sealant.
 - c. Extend jacket of outdoor insulation outside roof flashing at least 2 inches below top of roof flashing.
 - d. Seal jacket to roof flashing with flashing sealant.
2. Insulation Installation at Underground Exterior Wall Penetrations: Terminate insulation flush with sleeve seal. Seal terminations with flashing sealant.
3. Insulation Installation at Aboveground Exterior Wall Penetrations: Install insulation continuously through wall penetrations.
 - a. Seal penetrations with flashing sealant.
 - b. For applications requiring only indoor insulation, terminate insulation inside wall surface and seal with joint sealant. For applications requiring indoor and outdoor insulation, install insulation for outdoor applications tightly joined to indoor insulation ends. Seal joint with joint sealant.
 - c. Extend jacket of outdoor insulation outside of wall flashing and overlap wall flashing at least 2 inches.
 - d. Seal jacket to wall flashing with flashing sealant.
4. Insulation Installation at Interior Wall and Partition Penetrations (That Are Not Fire Rated): Install insulation continuously through walls and partitions.
5. Insulation Installation at Fire-Rated Wall and Partition Penetrations: Install insulation continuously through penetrations of fire-rated walls and partitions. Comply with requirements in Division 20 Section 20 0517: Penetrations for Mechanical, Plumbing, And Fire Suppression Systems for firestopping and fire-resistive joint sealers.
6. Insulation Installation at Floor Penetrations:
 - a. Pipe: Install insulation continuously through floor penetrations.
 - b. Duct: For penetration through fire-rated assemblies, terminate insulation at fire damper sleeves and externally insulate damper sleeve beyond floor to match adjacent duct insulation. Overlap damper sleeve and duct insulation at least 2 inches.
 - c. Seal penetrations through fire-rated assemblies. Comply with requirements in Section 20 0517: Penetrations for Mechanical, Plumbing, And Fire Suppression Systems.

3.3 INSTALLATION - PIPE INSULATION

- A. Requirements in this article generally apply to all insulation materials except where more specific requirements are specified in various pipe insulation material installation articles.
- B. Insulation Installation on Fittings, Valves, Strainers, Flanges, and Unions:
 1. Install insulation over fittings, valves, strainers, flanges, unions, and other specialties with continuous thermal and vapor-retarder integrity.

2. Insulate pipe elbows using preformed fitting insulation or mitered fittings made from same material and density as adjacent pipe insulation. Each piece shall be butted tightly against adjoining piece and bonded with adhesive. Fill joints, seams, voids, and irregular surfaces with insulating cement finished to a smooth, hard, and uniform contour that is uniform with adjoining pipe insulation.
 3. Insulate tee fittings with preformed fitting insulation or sectional pipe insulation of same material and thickness as used for adjacent pipe. Cut sectional pipe insulation to fit. Butt each section closely to the next and hold in place with tie wire. Bond pieces with adhesive.
 4. Insulate valves using preformed fitting insulation or sectional pipe insulation of same material, density, and thickness as used for adjacent pipe. Overlap adjoining pipe insulation by not less than two times the thickness of pipe insulation, or one pipe diameter, whichever is thicker. For valves, insulate up to and including the bonnets, valve stuffing-box studs, bolts, and nuts. Fill joints, seams, and irregular surfaces with insulating cement.
 5. Insulate strainers using preformed fitting insulation or sectional pipe insulation of same material, density, and thickness as used for adjacent pipe. Overlap adjoining pipe insulation by not less than two times the thickness of pipe insulation, or one pipe diameter, whichever is thicker. Fill joints, seams, and irregular surfaces with insulating cement. Insulate strainers so strainer basket flange or plug can be easily removed and replaced without damaging the insulation and jacket. Provide a removable reusable insulation cover. For below-ambient services, provide a design that maintains vapor barrier.
 6. Insulate flanges and unions using a section of oversized preformed pipe insulation. Overlap adjoining pipe insulation by not less than two times the thickness of pipe insulation, or one pipe diameter, whichever is thicker.
 7. Cover segmented insulated surfaces with a layer of finishing cement and coat with a mastic. Install vapor-barrier mastic for below-ambient services and a breather mastic for above-ambient services. Reinforce the mastic with fabric-reinforcing mesh. Trowel the mastic to a smooth and well-shaped contour.
 8. For services not specified to receive a field-applied jacket (except for Type CGP and Type FEP), install fitted PVC cover over elbows, tees, strainers, valves, flanges, and unions. Terminate ends with PVC end caps. Tape PVC covers to adjoining insulation facing using PVC tape.
 9. Label the outside insulation jacket of each union with the word "union." Match size and color of pipe labels.
- C. Insulate instrument connections for thermometers, pressure gages, pressure temperature taps, test connections, flow meters, sensors, switches, and transmitters on insulated pipes. Shape insulation at these connections by tapering it to and around the connection with insulating cement and finish with finishing cement, mastic, and flashing sealant.
- D. Install removable insulation covers at locations indicated. Installation shall conform to the following:
1. Make removable flange and union insulation from sectional pipe insulation of same thickness as that on adjoining pipe. Install same insulation jacket as adjoining pipe insulation.
 2. When flange and union covers are made from sectional pipe insulation, extend insulation from flanges or union long at least two times the insulation thickness over adjacent pipe insulation on each side of flange or union. Secure flange cover in place with stainless-steel or aluminum bands. Select band material compatible with insulation and jacket.

3. Construct removable valve insulation covers in same manner as for flanges, except divide the two-part section on the vertical center line of valve body.
 4. When covers are made from block insulation, make two halves, each consisting of mitered blocks wired to stainless-steel fabric. Secure this wire frame, with its attached insulation, to flanges with tie wire. Extend insulation at least 2 inches over adjacent pipe insulation on each side of valve. Fill space between flange or union cover and pipe insulation with insulating cement. Finish cover assembly with insulating cement applied in two coats. After first coat is dry, apply and trowel second coat to a smooth finish.
- E. Install vapor stops at all insulation terminations on either side of valves, pumps and equipment and particularly in straight lengths of pipe insulation.
- F. Installation of **Type GWP** Insulation
1. Insulation Installation on Straight Pipes and Tubes:
 - a. Secure each layer of preformed pipe insulation to pipe with wire or bands and tighten bands without deforming insulation materials.
 - b. Where vapor barriers are indicated, seal longitudinal seams, end joints, and protrusions with vapor-barrier mastic and joint sealant.
 - c. For insulation with factory-applied jackets on above-ambient surfaces, secure laps with outward-clinched staples at 6 inches o.c.
 - d. For insulation with factory-applied jackets on below-ambient surfaces, do not staple longitudinal tabs. Instead, secure tabs with additional adhesive as recommended by insulation material manufacturer and seal with vapor-barrier mastic and flashing sealant.
 - e. Longitudinal jacket laps for pipe insulation installed on piping systems with operating temperatures below ambient shall be vapor sealed with factory-applied pressure-sensitive adhesive vapor retarder, self-sealing lap. For proper sealing, firmly rub lap joints with reasonable pressure being applied with a plastic squeegee or sealing tool. Vapor seal all circumferential joints with factory-furnished, matching pressure-sensitive butt strips installed with reasonable pressure being applied with a plastic squeegee or sealing tool. Additionally, coat raw edges of pipe insulation sections with vapor retarder mastic at 12 foot to 21 foot intervals on straight piping, and on either side of all fittings, flanges, or valves. Vapor retarder mastic shall completely coat the ends of the pipe and extend onto the bore of the pipe insulation and onto the jacketing a minimum of 2 inches.
 2. Insulation Installation on Pipe Flanges:
 - a. Install preformed pipe insulation to outer diameter of pipe flange.
 - b. Make width of insulation section same as overall width of flange and bolts, plus twice the thickness of pipe insulation.
 - c. Fill voids between inner circumference of flange insulation and outer circumference of adjacent straight pipe segments with mineral-fiber blanket insulation.
 - d. Install jacket material with manufacturer's recommended adhesive, overlap seams at least 1 inch, and seal joints with flashing sealant.
 3. Insulation Installation on Pipe Fittings and Elbows:
 - a. Install preformed sections of same material as straight segments of pipe insulation when available.

- b. When preformed insulation elbows and fittings are not available, install mitered sections of pipe insulation, to a thickness equal to adjoining pipe insulation. Secure insulation materials with wire or bands.
 - c. Flexible fiberglass insert shall be wrapped completely around bare fitting. Multiple layers may be necessary to ensure adequate insulating thickness. Cover the fitting and insert with the fitted jacket cover. Fitting shall be tacked or taped in place on hot piping. Cold piping will require vapor barrier tape or mastic to ensure complete vapor barrier.
4. Insulation Installation on Valves and Pipe Specialties:
- a. Install preformed sections of same material as straight segments of pipe insulation when available.
 - b. When preformed sections are not available, install mitered sections of pipe insulation to valve body.
 - c. Arrange insulation to permit access to packing and to allow valve operation without disturbing insulation.
 - d. Install insulation to flanges as specified for flange insulation application.

3.4 INSTALLATION – DUCT AND EQUIPMENT INSULATION

A. General

1. Install a continuous unbroken vapor barrier. Create a facing lap for longitudinal seams and end joints with insulation by removing 2" from one edge and one end of insulation segment. Secure laps to adjacent insulation section with ½" outward-clinching staples, 1" o.c. Install vapor barrier consisting of factory- or field-applied jacket, adhesive, vapor-barrier mastic, and sealant at joints, seams, and protrusions.
 - a. Repair punctures, tears, and penetrations with tape or mastic to maintain vapor-barrier seal.
 - b. Install vapor stops for ductwork and plenums operating below 50F at 18-foot intervals. Vapor stops shall consist of vapor-barrier mastic applied in a Z-shaped pattern over insulation face, along butt end of insulation, and over the surface. Cover insulation face and surface to be insulated a width equal to two times the insulation thickness, but not less than 3".
 - c. Install vapor stops at all insulation terminations on either side of pumps and equipment.
2. Insulate duct stiffeners, hangers, and flanges that protrude beyond insulation surface with 6" wide strips of same material used to insulate duct. Secure on alternating sides of stiffener, hanger, and flange with pins spaced 6" o.c.
3. Where insulated ductwork is supported by trapeze hangers, the insulation shall be installed continuous through the hangers. Drop the supporting channels required to facilitate the installation of the insulation. Where rigid board or flexible insulation is specified, install high density inserts to prevent the weight of the ductwork from crushing the insulation.
4. Where insulated ductwork is supported by steel metal straps or wire ropes that are secured directly to the duct, the straps or ropes shall be completely covered with insulation and sealed to provide a complete vapor barrier.
5. Where insulated duct risers are supported by steel channels secured directly to the duct, extend the insulation and vapor barrier jacketing to encapsulate the support channels.
6. Insulation at access panels shall be removable with metal corner beads.

7. Insulation shall be omitted at all equipment name plates and/or data plates.
8. Insulate all duct-mounted hot water booster coils with insulation equivalent to that on the adjacent ductwork.
9. Duct mounted sensors and other devices to be installed on the outside of the insulation. Seal and provide complete vapor barrier at any penetrations of the insulation.

B. Installation of **Type MF-FB** duct insulation

1. Install Duct Wrap using manufacturer's stretch-out tables to obtain specified R-value using a maximum compression of 25%.
2. Secure blanket insulation with weld pins.
3. Install either capacitor-discharge-weld pins and speed washers or cupped-head, capacitor-discharge-weld pins on sides and bottom of horizontal ducts and sides of vertical ducts as follows:
 - a. On duct sides with dimensions 18" and smaller, place pins along longitudinal centerline of duct. Space 3" maximum from insulation end joints, and 16" o.c.
 - b. On duct sides with dimensions larger than 18", place pins 16" o.c. each way, and 3" maximum from insulation joints. Install additional pins to hold insulation tightly against surface at cross bracing.
 - c. Pins may be omitted from top surface of horizontal, rectangular ducts and plenums.
 - d. Do not over-compress insulation during installation.
 - e. Impale insulation over pins and attach speed washers.
 - f. Cut excess portion of pins extending beyond speed washers or bend parallel with insulation surface. Cover exposed pins and washers with tape matching insulation facing.
4. Overlap unfaced blankets a minimum of 2" on longitudinal seams and end joints. At end joints, secure with steel bands spaced a maximum of 18" o.c.
5. Install insulation on rectangular duct elbows and transitions with a full insulation section for each surface. Install insulation on round and flat-oval duct elbows with individually mitered gores cut to fit the elbow.

C. Installation of **Type MF-RB** duct insulation

1. Secure rigid board insulation with weld pins.
2. Install either capacitor-discharge-weld pins and speed washers or cupped-head, capacitor-discharge-weld pins on sides and bottom of horizontal ducts and sides of vertical ducts as follows:
 - a. On duct sides with dimensions 18" and smaller, place pins along longitudinal centerline of duct. Space 3" maximum from insulation end joints, and 16" o.c.
 - b. On duct sides with dimensions larger than 18", space pins 16" o.c. each way, and 3" maximum from insulation joints. Install additional pins to hold insulation tightly against surface at cross bracing.
 - c. Pins may be omitted from top surface of horizontal, rectangular ducts and plenums.
 - d. Do not over-compress insulation during installation.
 - e. Cut excess portion of pins extending beyond speed washers or bend parallel with insulation surface. Cover exposed pins and washers with tape matching insulation facing.

3. Install insulation on rectangular duct elbows and transitions with a full insulation section for each surface. Groove and score insulation to fit as closely as possible to outside and inside radius of elbows. Install insulation on round and flat-oval duct elbows with individually mitered gores cut to fit the elbow.
- D. Installation of Type **MF-SRB** equipment insulation
1. Apply insulation to equipment shells using weld pins, bonding adhesive, banded and wired in place.
 2. Groove and score insulation materials to fit as closely as possible to equipment, including contours. Bevel insulation edges for cylindrical surfaces for tight joints. Stagger end joints.
 3. Protect exposed corners with secured corner angles.
 4. Install adhesively attached or self-sticking insulation hangers and speed washers on sides of tanks and vessels as follows:
 - a. Do not weld anchor pins to ASME-labeled pressure vessels.
 - b. Select insulation hangers and adhesive which are compatible with service temperature and with substrate.
 - c. On tanks and vessels, maximum anchor-pin spacing is 3" from insulation end joints, and 16" o.c. in both directions.
 - d. Do not over-compress insulation during installation.
 - e. Cut and miter insulation segments to fit curved sides and domed heads of tanks and vessels.
 - f. Impale insulation over anchor pins and attach speed washers.
 - g. Cut excess portion of pins extending beyond speed washers or bend parallel with insulation surface. Cover exposed pins and washers with tape matching insulation facing.
 5. Secure each layer of insulation with stainless-steel or aluminum bands. Select band material compatible with insulation materials.
 6. Where insulation hangers on equipment and vessels are not permitted or practical and where insulation support rings are not provided, install a girdle network for securing insulation. Stretch pre-stressed aircraft cable around the diameter of vessel and make taut with clamps, turnbuckles, or breather springs. Place one circumferential girdle around equipment approximately 6" from each end. Install wire or cable between two circumferential girdles 12" o.c. Install a wire ring around each end and around outer periphery of center openings, and stretch pre-stressed aircraft cable radially from the wire ring to nearest circumferential girdle. Install additional circumferential girdles along the body of equipment or tank at a minimum spacing of 48" o.c. Use this network for securing insulation with tie wire or bands.
 7. Stagger joints between insulation layers at least 3".
 8. Install insulation in removable segments on equipment access doors, manholes, handholes, and other elements that require frequent removal for service and inspection.
 9. Bevel and seal insulation ends around manholes, handholes, ASME stamps, and nameplates.
 10. For equipment with surface temperatures below ambient, apply mastic to open ends, joints, seams, breaks, and punctures in insulation.

3.5 APPLICATION (PIPING)

A. Schedule

PIPING SYSTEM	OPERATING TEMP (°F)	INSULATION TYPE	INDOOR JACKET	OUTDOOR JACKET
WARM AND HOT HVAC PIPING SYSTEMS				
Heating water supply and return	141F to 200F	GWP	ASJ+	ALUM
Boiler condensate drain	40F to 60F	GWP	ASJ+	N/A

B. Insulation thickness shall be per the following table, unless specific exceptions are listed.

OPERATING TEMPERATURE (F)	INSULATION CONDUCTIVITY		NOMINAL PIPE SIZE				
	'k' Value (Btu in/hr ft²)	Mean Rating Temp (°F)	<1"	1" to <1½"	1½" to < 4"	4" to < 8"	≥8"
>350F	0.32 to 0.34	250	4.5	5.0	5.0	5.0	5.0
251 to 350F	0.29 to 0.32	200	3.0	4.0	4.5	4.5	4.5
201 to 250F	0.27 to 0.30	150	2.5	2.5	2.5	3.0	3.0
141 to 200F	0.25 to 0.29	125	1.5	1.5	2.0	2.0	2.0
105 to 140F	0.22 to 0.28	100	1.0	1.0	1.5	1.5	1.5
40 to 60F	0.21 to 0.27	75	1.5	1.5	1.5	1.5	1.5
<40F	0.20 to 0.26	50	1.5	1.5	2.0	2.0	2.0
40 – 60F with Type CGP	0.28 to 0.29	75	1.5	1.5	1.5 up to 2" pipe 2.0 above 2" pipe	2.0	2.0 up to 12" pipe 2.5" up to 24" pipe

C. Exceptions to pipe insulation thickness table:

- Boiler Condensate Drains: 1" thick

D. For above ambient services, do not install insulation on vibration control devices.

3.6 APPLICATION – DUCTWORK

A. Provide insulation on new ductwork and modified portions of existing ductwork per the following schedule:

SERVICE	INSULATION TYPE	INSULATION THICKNESS	JACKET
Outdoor air ducts and plenums: Indoor, exposed	MF-RB	1.5"	FSK
Mixed air ducts and plenums: Indoor, exposed	MF-RB	1.5"	FSK
Return air ducts: Indoor	None	N/A	N/A

SERVICE	INSULATION TYPE	INSULATION THICKNESS	JACKET
Boiler breeching, single-wall	MF-SRB	3"	Aluminum

- B. Insulate all duct-mounted hot water booster coils with insulation equivalent to that on the adjacent ductwork.
- C. The following systems do not require insulation:
 1. Metal ducts with duct liner
 2. Factory insulated plenums and casings
 3. Factory insulated flexible ductwork
 4. Factory insulated access panels and doors

3.7 APPLICATION - EQUIPMENT

- A. Provide insulation on new equipment per the following schedule:

EQUIPMENT	INSULATION TYPE	INSULATION THICKNESS	JACKET
WARM AND HOT EQUIPMENT			
Expansion/Compression tanks	MF-SRB	2"	PVC
Air separators	MF-SRB	2"	PVC
Chemical pot feeders	MF-SRB	1.5"	PVC

- B. Provide removable sections of insulation where required for service.
- C. For above ambient services, do not install insulation to the following:
 1. Vibration control devices
 2. Nameplates and data plates
 3. Manholes and handholes
 4. Cleanouts

3.8 TESTING

- A. Insulation Inspection Test
 1. Inspect pipe, fittings, strainers, and valves, randomly selected by Engineer, by removing field-applied jacket and insulation in layers in reverse order of their installation. Extent of inspection shall be limited to three locations of straight pipe, three locations of threaded fittings, three locations of welded fittings, two locations of threaded strainers, two locations of welded strainers, three locations of threaded valves, and three locations of flanged valves for each pipe service defined in the "Piping Insulation Schedule, General" Article.
 2. All insulation applications will be considered defective Work if sample inspection reveals noncompliance with requirements.

3. Provide test result report within two weeks of testing indicating satisfactory compliance with specification.

END OF SECTION

P:\22 Projects\P22-1142-00coev\04 Design\07 Specs\Div 20\20 0700-Thermal Insulation for M-P-FP.docx

SPECIFICATIONS

DIVISION 23 MECHANICAL

SECTION 23 0100	COMMON WORK REQUIREMENTS FOR MECHANICAL
SECTION 23 0593	TESTING, ADJUSTING, AND BALANCING FOR HVAC
SECTION 23 0900	BASIC TEMPERATURE CONTROL REQUIREMENTS
SECTION 23 0903	TEMPERATURE CONTROL CONDUIT
SECTION 23 0904	TEMPERATURE CONTROL WIRING
SECTION 23 0906	TEMPERATURE CONTROL DEMOLITION
SECTION 23 0911	CONTROL VALVES
SECTION 23 0912	CONTROL DAMPERS
SECTION 23 0927	TEMPERATURE INSTRUMENTS
SECTION 23 1113	FUEL GAS PIPING
SECTION 23 2113	HYDRONIC PIPING AND SPECIALTIES
SECTION 23 2500	PIPE CLEANING, FLUSHING, AND CHEMICAL TREATMENT
SECTION 23 3113	METAL AND FLEXIBLE DUCT
SECTION 23 5100	BREECHINGS, CHIMNEYS, AND STACKS
SECTION 23 5216	CONDENSING HYDRONIC BOILERS

**SECTION 23 0100
COMMON WORK REQUIREMENTS FOR MECHANICAL**

PART 1 - GENERAL

1.1 SECTION INCLUDES

- A. Basic requirements applicable to all Division 23 work.

1.2 RELATED SECTIONS

- A. All specification sections in Division 20 are applicable to Division 23. It is the responsibility of the Division 23 Contractor to obtain all Division 20 specifications and conform to all applicable requirements. Division 20 Sections included are:
 - 1. Section 20 2923: Variable Frequency Drives for Mechanical, Plumbing, and Fire Suppression
 - 2. Section 20 9100: Painting for Mechanical, Plumbing, and Fire Suppression
 - 3. Section 20 0500: Basic Requirements for Mechanical, Plumbing, and Fire Suppression
 - 4. Section 20 0501: Minor Mechanical, Plumbing, and Fire Suppression Demolition
 - 5. Section 20 0516: Expansion Compensation for Mechanical, Plumbing, and Fire Suppression
 - 6. Section 20 0517: Penetrations for Mechanical, Plumbing, and Fire Suppression
 - 7. Section 20 0519: Meters And Gauges for Mechanical, Plumbing, and Fire Suppression
 - 8. Section 20 0529: Hangers and Supports for Mechanical, Plumbing and Fire Suppression Systems
 - 9. Section 20 0548: Vibration Isolation for Mechanical, Plumbing and Fire Suppression
 - 10. Section 20 0553: Identification for Mechanical, Plumbing, and Fire Suppression Systems
 - 11. Section 20 0700: Thermal Insulation for Mechanical, Plumbing, and Fire Suppression

PART 2 - PRODUCTS

Not Applicable

PART 3 - EXECUTION

3.1 SCOPE

- A. Work included under Divisions 20 and 23 shall include all labor, services, materials, and equipment and performance of all work required for installation of plumbing systems as shown on Drawings and as specified.

END OF SECTION

P:\22 Projects\22-1142-00coev\04 Design\07 Specs\Div 23\23 0100-Common Work Requirements for Mechanical.docx

SECTION 23 0593
TESTING, ADJUSTING, AND BALANCING FOR HVAC

PART 1 - GENERAL

1.1 SCOPE OF WORK

- A. This Section includes testing, adjusting, and balancing to produce design objectives for the following:
 - 1. Air systems
 - 2. Hydronic Piping Systems
 - 3. Existing systems TAB
 - 4. Operating test

1.2 DEFINITIONS

- A. Adjust: To regulate fluid flow rate and air patterns at the terminal equipment, such as to reduce fan speed or adjust a damper.
- B. Balance: To proportion flows within the distribution system, including submains, branches, and terminals, according to indicated quantities.
- C. Barrier or Boundary: Construction, either vertical or horizontal, such as walls, floors, and ceilings that are designed and constructed to restrict the movement of airflow, smoke, odors, and other pollutants.
- D. Draft: A current of air, when referring to localized effect caused by one or more factors of high air velocity, low ambient temperature, or direction of airflow, whereby more heat is withdrawn from a person's skin than is normally dissipated.
- E. NC: Noise criteria.
- F. Procedure: An approach to and execution of a sequence of work operations to yield repeatable results.
- G. RC: Room criteria.
- H. Report Forms: Test data sheets for recording test data in logical order.
- I. Smoke-Control System: An engineered system that uses fans to produce airflow and pressure differences across barriers to limit smoke movement.
- J. Smoke-Control Zone: A space within a building that is enclosed by smoke barriers and is a part of a zoned smoke-control system.
- K. Stair Pressurization System: A type of smoke-control system that is intended to positively pressurize stair towers with outdoor air by using fans to keep smoke from contaminating the stair towers during an alarm condition.
- L. Static Head: The pressure due to the weight of the fluid above the point of measurement. In a closed system, static head is equal on both sides of the pump.
- M. Suction Head: The height of fluid surface above the centerline of the pump on the suction side.
- N. System Effect: A phenomenon that can create undesired or unpredicted conditions that cause reduced capacities in all or part of a system.

- O. System Effect Factors: Allowances used to calculate a reduction of the performance ratings of a fan when installed under conditions different from those presented when the fan was performance tested.
- P. TAB: Testing, adjusting, and balancing.
- Q. Terminal: A point where the controlled medium, such as fluid or energy, enters or leaves the distribution system.
- R. Test: A procedure to determine quantitative performance of systems or equipment.
- S. Testing, Adjusting, and Balancing Firm: The entity responsible for performing and reporting TAB procedures.

1.3 CODES AND STANDARDS (USE LATEST EDITIONS)

- A. ASHRAE 111: Practices for Measurement, Testing, Adjusting, and Balancing of Building Heating, Ventilation, Air-conditioning, and Refrigeration Systems.
- B. Associated Air Balance Council (AABC): National Standards for Total System Balance.
- C. ANSI S12.1: Physical Measurement of Sound
- D. National Environmental Balancing Bureau (NEBB): Procedural Standards for Testing, Adjusting, and Balancing of Environmental Systems.
- E. National Environmental Balancing Bureau (NEBB): Procedural Standard for Fume Hood Performance Testing.
- F. National Environmental Balancing Bureau (NEBB): Procedural Standards for Certified Testing of Cleanrooms.
- G. National Environmental Balancing Bureau (NEBB): Procedural Standards for Measurement of Sound and Vibration.
- H. Sheet Metal and Air Conditioning Contractors' National Association (SMACNA): TAB Procedural Guide.
- I. Sheet Metal and Air Conditioning Contractors' National Association (SMACNA): HVAC Sound and Vibration Manual

1.4 QUALITY ASSURANCE

- A. Qualifications
 - 1. Testing agency shall be a certified member of AABC, NEBB, and/or TABB.
 - 2. Testing and Balancing shall be performed by a testing agency who specializes in testing, adjusting, and balancing of heating, ventilating, air-moving equipment, air-conditioning systems and hydronic systems and has a minimum of one year experience.
 - 3. Testing agency shall have successfully completed a minimum of five projects, similar in size and scope.
- B. Certifications - TAB Technician shall be certified by a nationally recognized certifying agency.
- C. TAB Conference: Meet with Owner's and Architect's representatives on approval of TAB strategies and procedures plan to develop a mutual understanding of the details. Ensure the participation of TAB team members, equipment manufacturers' authorized service representatives, HVAC controls

installers, and other support personnel. Provide seven (7) days' advance notice of scheduled meeting time and location.

1. Agenda Items: Include at least the following:
 - a. Submittal distribution requirements
 - b. The Contract Documents examination report
 - c. TAB plan
 - d. Work schedule and Project-site access requirements
 - e. Coordination and cooperation of trades and subcontractors
 - f. Coordination of documentation and communication flow
- D. Instrumentation Type, Quantity, and Accuracy: As described in AABC's "National Standards for Total System Balance," NEBB's "Procedural Standards for Testing, Adjusting, and Balancing of Environmental Systems," Section II, "Required Instrumentation for NEBB Certification," or the TABB Instrument List.
- E. Instrumentation Calibration: Calibrate instruments at least every six months or more frequently if required by instrument manufacturer.
 1. Keep an updated record of instrument calibration that indicates date of calibration and the name of party performing instrument calibration.

1.5 SUBMITTALS

- A. Preconstruction – Prior to construction provide the following in accordance with Specification 20 0500 – Basic Requirements for Mechanical, Plumbing, and Fire Suppression:
 1. TAB Contract Document Examination Report: Within 30 days from Contractor's Notice to Proceed.
 2. Strategies and Procedures Plan: Within 60 days from Contractor's Notice to Proceed.
- B. During Construction – During construction provide and maintain the following in accordance with Specification 20 0500 – Basic Requirements for Mechanical, Plumbing, and Fire Suppression:
 1. Deficiency Report
 2. Preliminary TAB Reports
- C. Contract Closeout – At contract closeout provide the following in accordance with Specification 20 0500 – Basic Requirements for Mechanical, Plumbing, and Fire Suppression:
 1. Certified TAB Reports
 2. Warranties.

1.6 PROJECT CONDITIONS

- A. Full Owner Occupancy: Owner will occupy the site and existing building during entire TAB period. Cooperate with Owner during TAB operations to minimize conflicts with Owner's operations.

1.7 COORDINATION

- A. Coordinate the efforts of factory-authorized service representatives for systems and equipment, HVAC controls installers, and other mechanics to operate HVAC systems and equipment to support and assist TAB activities.

- B. Notice: Provide seven days' advance notice for each test. Include scheduled test dates and times.
- C. Perform TAB after leakage and pressure tests on air and water distribution systems have been satisfactorily completed.

1.8 WARRANTY

- A. Provide one of the following performance guarantees:
 - 1. AABC National Project Performance Guarantee
 - 2. NEBB Certificate of Conformance Certification
 - 3. TABB Quality Assurance Program Guarantee
- B. Guarantee shall include the following provisions:
 - 1. The certified TAB firm has tested and balanced systems according to the Contract Documents.
 - 2. Systems are balanced to optimum performance capabilities within design and installation limits.

PART 2 - PRODUCTS

2.1 ACCEPTABLE FIRMS

- A. Aero Building Solutions., Franklin Park, IL
- B. International Test & Balance, Northbrook, IL
- C. Superior Test & Balance, Inc., Algonquin, IL

2.2 TESTING SCOPE

- A. The following systems shall be tested in accordance with the procedures defined in Part 3 of this specification:
 - 1. Air systems
 - 2. Hydronic systems
 - 3. Boilers
 - 4. Existing air and hydronic systems

PART 3 - EXECUTION

3.1 GENERAL

- A. Provide sufficient time before completion date to complete balancing operations.
- B. Note changes made to the system during construction.
- C. Install required test holes complete with removable and replaceable plugs.
- D. Make and document revisions to controls, dampers, fan and pump drives, and consult with equipment manufacturers as required to achieve the specified system's performance.
- E. Take and report testing and balancing measurements in inch-pound (IP) units.
- F. Cut insulation, ducts, pipes, and equipment cabinets for installation of test probes to the minimum extent necessary to allow adequate performance of procedures. After testing and balancing, close

probe holes and patch insulation with new materials identical to those removed. Restore vapor barrier and finish according to insulation Specifications for this Project.

- G. Mark equipment and balancing device settings with paint or other suitable, permanent identification material, including damper-control positions, valve position indicators, fan-speed-control levers, and similar controls and devices, to show final settings.

3.2 EXAMINATION

- A. Examine the Contract Documents to become familiar with Project requirements and to review system designs for deficiencies that may prevent proper TAB.
- B. Examine approved submittal data of HVAC systems and equipment.
- C. Examine equipment performance data including fan and pump curves. Relate performance data to Project conditions and requirements, including system effects that can create undesired or unpredicted conditions that cause reduced capacities in all or part of a system. Calculate system effect factors to reduce performance ratings of HVAC equipment when installed under conditions different from those presented when the equipment was performance tested at the factory. To calculate system effects for air systems, use tables and charts found in AMCA 201, "Fans and Systems,;" or in SMACNA's "HVAC Systems – Duct Design,.". Compare this data with the design data and installed conditions.

3.3 PREPARATION

- A. Prepare a Strategies and Procedures Plan that includes TAB strategies and step-by-step procedures as specified in Part 3 of these specifications.
- B. Prior to commencing the TAB verify the following conditions. If deficiencies are evident, submit Deficiency Report to Owner. Do not begin TAB until deficiencies have been remedied.
 - 1. Systems are started and operating in a safe and normal condition.
 - 2. Temperature control systems are installed, complete, and operable.
 - 3. Automatic and manual dampers are operable and fully open.
 - 4. Thermal overload protection is in place for fans, pumps, and other equipment.
 - 5. Fans are rotating correctly.
 - 6. Hydronic systems are pressure tested, flushed, filled, and properly vented.
 - 7. Pumps are rotating correctly.
 - 8. Start-up/construction strainers have been removed and all permanent strainers are clean and in place.
 - 9. Gauges and/or test ports are properly located for balancing.
 - 10. Service and balance valves are fully open.

3.4 TOLERANCES

- A. Air Systems
 - 1. Air Handling Systems: Adjust to within +10% of outlet total plus allowable leakage rate.

- B. Hydronic Systems
 - 1. Hydronic Systems: Adjust to within +10% of design flow.

3.5 AIR SYSTEMS PROCEDURE

- A. Perform testing and balancing procedures on each system according to any of the following:
 - 1. AABC National Standards for Total System Balance
 - 2. NEBB Procedural Standards for Testing, Adjusting, and Balancing of Environmental Systems
 - 3. SMACNA TAB Procedural Guide
 - 4. ASHRAE 111 Measurement, Testing, Adjusting, and Balancing of Building HVAC Systems
- B. Minimum air procedures shall include the following:
 - 1. Test and adjust fan RPM to design requirements.
 - 2. Test and record motor full load nameplate rating and actual ampere draw.
 - 3. Test and record system static pressures, fan suction, and discharge.
 - 4. Test and adjust air handling and distribution systems to provide required supply air quantities within design tolerance.

3.6 HYDRONIC SYSTEMS PROCEDURE

- A. Perform testing and balancing procedures on each system according to the procedures contained in AABC - National Standards for Total System Balance, NEBB - Procedural Standards for Testing, Adjusting, and Balancing of Environmental Systems, or SMACNA - TAB Procedural Guide and this Section.
- B. Minimum hydronic procedures shall include the following:
 - 1. Prepare itemized equipment schedules listing all heating and/or cooling elements and equipment in the systems to be balanced. List in order on equipment schedules, by pump or zone according to the design, all heating and/or cooling elements, all zone balancing valves, and circuit pumps, ending with the last items of equipment or transfer element in the respective zone or circuit. Include on schedule sheet column titles listing the location, type of element or apparatus, design conditions, and measured conditions. Prepare individual pump report sheets for each zone or circuit.
 - 2. Adjust hydronic systems to provide plus or minus 10% of required design quantities.
 - 3. Use calibrated Venturi tubes, orifices, metered fittings, pressure gages, and direct-reading instrumentation to determine flow rates for system balance. Where flow-metering devices are not installed, flow balance on temperature difference across various heat transfer elements in the system is acceptable.
 - 4. Effect system balance with automatic control valves fully open to heat or cooling transfer elements.
 - 5. Adjust hydronic distribution systems by means of balancing cocks, valves, and fittings. Do not use service or shut-off valves for balancing unless indexed for balance point.
 - 6. Test pumps and adjust flow. Record the following on pump report sheets:
 - a. Suction and discharge pressure.

- b. Running amps and brake horsepower of pump motor under full flow and no flow conditions.
 - c. Pressure drop across pump in feet of water and total GPM pump is handling under full flow conditions.
7. Where available pump capacity is less than total flow requirements or individual system parts, proportional balancing must be performed.

3.7 REPORTING

- A. TAB Contract Document Examination Report: Based on examination of the Contract Documents as specified in "Examination" Article, prepare a report on the adequacy of design for systems' balancing devices. Recommend changes and additions to systems' balancing devices to facilitate proper performance measuring and balancing. Recommend changes and additions to HVAC systems and general construction to allow access for performance measuring and balancing devices.
- B. Deficiency Report: Following examination of installed system, prior to balancing, submit report indicating system deficiencies that would prevent proper testing, adjusting, and balancing of systems and equipment to meet specified performance.
- C. Preliminary TAB Reports: Submit one copy of the preliminary testing, adjusting and balancing report without field data, including any drawings indicating air outlets, thermostats, and equipment identified to correspond with data sheets.
- D. Certified TAB Reports
 - 1. Submit two copies of reports prepared, as specified in this Section, on approved forms certified by TAB firm.
 - 2. General: Typewritten, or computer printout in letter-quality font, on standard bond paper, in three-ring binder, tabulated and divided into sections by tested and balanced systems.
 - 3. TAB Report Forms: Use standard forms from AABC, NEBB or TABB/SMACNA.
 - 4. Minimum Certified TAB Reports shall include the following:
 - a. Certification sheet in front of binder signed and sealed by the certified testing and balancing engineer.
 - b. List of instruments used for procedures, along with proof of calibration.
 - c. Certified TAB field data reports. This certification includes the following:
 - (1) Review field data reports to validate accuracy of data and to prepare certified TAB reports.
 - (2) Certify that TAB team complied with approved TAB plan and the procedures specified and referenced in this Specification.
 - d. Pump curves
 - e. Manufacturers' test data
 - f. Field test reports prepared by system and equipment installers
 - g. Other information relative to equipment performance, but do not include Shop Drawings and Product Data

- h. Where specified, vibration and/or sound measurement report in accordance with the requirements of the current edition of the NEBB Procedural Standards for Measurement of Sound and Vibration.

END OF SECTION

P:\22 Projects\IP22-1142-00coev\04 Design\07 Specs\Div 23\23 0593-Testing Adjusting and Balancing for HVAC.docx

SECTION 23 0900
BASIC TEMPERATURE CONTROL REQUIREMENTS

PART 1 - GENERAL

1.1 SECTION INCLUDES

- A. Scope
- B. Quality Assurance
- C. Specifications
- D. Project/Site Conditions
- E. Work by Subcontractors
- F. Coordinated Work
- G. Project Phasing
- H. Hazardous Materials
- I. Design Submittals
- J. Start-up and Testing
- K. Guarantee
- L. Closeout Submittals
- M. Record Documents
- N. Operating and Maintenance (O&M) Manuals
- O. Training

1.2 SCOPE

- A. The purpose of this project is to update, replace and expand the existing energy management and control systems.
- B. The work includes the complete installation of an electronic building automation, energy management and temperature control system as identified below:
 - 1. Control for the following systems:
 - (1) New boiler controller tie-in to existing Siemens control BAS.
 - (2) Complete raceway system.
 - (3) Related software.
- C. Contractor must take special precautions at all times to prevent any damage to Owner's equipment or premises. This Contractor shall be liable for any damage.
- D. Contractor shall obtain and pay for all necessary construction permits and licenses.

1.3 QUALITY ASSURANCE

- A. Materials and equipment shall be the catalogued products of manufacturers regularly engaged in production and installation of automatic temperature control systems and shall be the manufacturer's latest standard design that complies with the specification requirements.

- B. All electronic equipment shall conform to the requirements of FCC Regulation, Part 15, Section 15, "Governing Radio Frequency Electromagnetic Interference" and be so labeled.
- C. The Contractor shall employ specialists in the field of Building Automation Systems including: Programming, Engineering, Field Supervision and Installation. Specialists shall have a minimum of 5 years of experience with Building Automation Systems.
- D. The Contractor shall be responsible for all work fitting into place in a satisfactory, neat, workmanlike manner acceptable to the Owner and Engineer.

1.4 SPECIFICATIONS

- A. The Contract Documents are to be considered scope in coverage only and do not necessarily show the exact location and details of the work to be installed. It shall be the responsibility of the Contractor to furnish and install the work in conformity with the requirements of these Specifications, the applicable codes, regulations and standards, the best trade practices and to meet with the approval of Owner. If any departures from the Contract Drawings are deemed necessary by the Contractor, details of such departures and the reasons therefore shall be submitted immediately to Engineer for approval.
- B. If the drawings and/or specifications are in conflict with governing codes, the Contractor shall submit proposal with appropriate modifications to the project to meet code restrictions. If this specification and associated drawings exceed governing code requirements, this specification shall govern.
- C. If the drawings and specifications are in conflict with each other, the more stringent shall apply.

1.5 PROJECT/SITE CONDITIONS

- A. Before submitting Proposal, the Contractor shall visit and carefully examine the individual sites so as to familiarize himself with existing conditions, the amount of work required, the working hours and special auxiliary restrictions of the project requirements including storage and delivery of materials.
- B. The Contractor shall verify all conditions on the job which may affect the installation of the work, and shall familiarize himself with applicable local and state regulations. Any discrepancies or interferences shall be reported immediately to Engineer. Additions to the contract price will not be allowed when they are due to the failure of the Contractor to carefully inspect existing condition.
- C. The submission of a Proposal will be construed as evidence that such examination has been made. Later claims for labor, equipment or material required for difficulties encountered, which could have been foreseen had such examination and evaluation have been, will not be recognized.

1.6 WORK BY SUBCONTRACTORS

- A. All Subcontractors to the Contractor shall be approved by Owner.
- B. The Contractor shall be totally responsible for his work and all work by his Subcontractors.

1.7 COORDINATED WORK

- A. This Contractor shall cooperate with other contractors performing work on this project, or other projects at the site, as necessary to achieve a complete, neatly fitting installation for each condition. To that end, each Contractor shall consult the drawings and specifications, for all trades to determine nature and extent of other work.

1.8 PROJECT PHASING

- A. This project will be completed during the cooling when season when the heating hot water system is

1.9 HAZARDOUS MATERIALS

- A. If hazardous materials including, but not limited to, asbestos, pollutants, or PCB are in any way suspected, inform Owner immediately and suspend work on that portion of the project.

PART 2 - PRODUCTS

Not Applicable

PART 3 - EXECUTION

3.1 DESIGN SUBMITTALS

- A. Submit all design submittals within 30 days after award of contract.
 - 1. Submit electronic copies of all drawings and product data every time a submission is made until final approval.
 - 2. Separate submittals may be made hardware and software.
- B. Engineer shall review and comment on copies submitted.
- C. If design does not conform to the design intent, Contractor shall resubmit to Engineer.
- D. No construction may begin until the design is approved for conformity with specification's intent by Engineer.
- E. Submittals and drawings shall be sufficient to:
 - 1. Show that the intent of the specification has been met.
 - 2. Provide a document for use by Owner showing all equipment incorporated into the system including both new and existing.
 - 3. Provide a document for use by Owner showing all equipment pneumatic and wiring connections of the system for both new and existing equipment.
- F. Items to be included in hardware drawings at minimum are:
 - 1. Include a complete bill of material of equipment used indicating quantity, manufacturer and model number and other relevant technical data.
 - 2. Include manufacturer's description and technical data, such as performance curves, product specification sheets and installation/maintenance instructions for the items listed in Division 23 Section 23 0901, "Temperature Control Hardware."
 - 3. Provide each electrically operated device with completely coded interconnection wiring diagrams. Show all termination and wiring numbers.
 - 4. Provide schematic wiring diagrams for each control panel. Show all terminations and wiring numbers.
 - 5. Provide schematic wiring diagrams for all field sensors and controllers.
 - 6. All schematic diagrams shall show both new and existing equipment for a complete control system schematic.

7. Provide system schematic diagrams for heating plant, exhaust/ventilation systems for the boilers, and all other miscellaneous points. Schematics to indicate every monitored/controlled point associated with that system.
- G. Items to be included in software drawings at minimum are:
1. Include a complete description of the operation of the temperature control/monitoring system, including sequences of operation.
 - a. Such descriptions are to be in Contractor's own words and not identically repeated from the Drawings.
 - b. Where sequences indicate, imply or suggest the use of "look-up" tables based on testing to be performed during the project, Contractor shall include such tables using "best-guess" values as place-holders. Contractor shall use actual measured values as they become available.
 2. Provide identification of those portions of the control sequences which are defined and activated by the Operator Workstation.
 3. Provide the control loop algorithms/calculations proposed.
 4. Provide a controller point list, including both inputs and outputs (I/O), indicating I/O point number, the controlled device associated with the I/O point and the location of the I/O device.
 5. Provide schedules, lists or other documentation of all operation parameters.
 6. The Contractor shall provide eight (8) hours of labor at Engineer's office for the principal program writer to meet with Engineer to interpret/review line by line programming.
- H. No work may begin on any segment (hardware or software) of this project until the design for the respective segment has been reviewed by Engineer for conformity with the specification design intent.
- I. Quantities of items submitted will not be reviewed by Engineer and are the responsibility of the Contractor.
- J. When manufacturer's cut sheets apply to a product series rather than a specific product, the data specifically applicable to the project shall be highlighted or clearly indicated by other means. Clearly note exact models, options and accessories being provided. General catalogs will not be accepted as cut sheets to fulfill submittal requirements.
- K. Drawings and product data not bearing the approval stamp of the Contractor, showing Contractor has reviewed and approved, or containing deviations from the contract documents, will be returned to the Contractor for resubmittal for compliance with above requirements.
- L. Equipment furnished and installed which is not reviewed by Engineer and not conforming to the design concept of the project will have to be removed and replaced with acceptable equipment all at the cost of the Contractor.
- M. Corrections or changes indicated on drawings and product data shall not be considered as extra work order.
- N. Engineer's checking and reviewing of drawings is a gratuitous assistance and in no way relieves the Contractor from responsibility for errors or omissions which may exist on the drawings. Whenever such error or omissions are discovered, they must be made good by the Contractor, without any additional cost to Owner, irrespective of any review by Engineer.

- O. Provide to Engineer any additional information or data which they deem necessary to determine compliance with these specifications or which they deem valuable in documenting the equipment to be installed.

3.2 START-UP AND TESTING

- A. Where new digital controls are being installed they shall be installed to the greatest extent possible before switch over from the existing temperature control system.
 - 1. Prior to switch over, the controllers shall be completely installed, checked and tested.
 - 2. Controller software and hardware shall be verified prior to switch over.
- B. Prior to testing and verifying proper system operation, Contractor shall furnish Engineer, for acceptance, electronic copies of the start-up/testing procedure proposed. Engineer must approve the check-out procedure prior to start up/testing.
- C. The start-up/testing procedure shall be submitted in writing one (1) calendar month prior to the projected start of start-up/testing.
- D. Check out procedure must include provisions for technicians to specifically check off procedures or tests performed.
- E. At minimum, the following shall be included in the checkout procedure:
 - 1. The Contractor shall test and verify proper operation for each control loop.
 - 2. Each control loop check will verify that the controller, manual override, fail safe control and electric interlocks are operating as intended to accomplish the control strategy.
 - a. Provide to Engineer trend logs of a minimum of thirty minutes in length, sampling no less frequently than every one minute, registering analog values of controlled variables showing that control loops respond adequately during system start up as well as steady state conditions. Logs must show the loop response to a step input of at least 5°F change in setpoint or 10% relative humidity change in setpoint.
 - 3. Contractor shall test and verify that correct terminations/designations of I/O are in place for each input and output.
 - 4. Contractor shall test and verify that sensors are properly calibrated, operational, and are within the performance parameters established in this specification.
 - a. Contractor shall have onsite instrumentation to calibrate/verify all analog input sensing. Instruments shall themselves be properly calibrated and be of greater accuracy than the sensors installed.
 - 5. Contractor shall test and verify onsite that operator interface menus and help screens are properly displayed, and that point names and designations are correct.
 - 6. Contractor shall test and verify communications between controllers.
- F. Start-up of the new digital control system must be phased with the phases of construction on this project. Start-up of an individual digital controller shall be planned such that the entire switch-over and checkout of a system can occur in less than one day. Incomplete or unverified controller systems shall not be left in operation overnight without permission of Owner.
 - 1. Contractor will not be allowed to switch over additional systems until the present controller being worked on is 100% complete.

- G. After the procedure is approved and after portions of the system are complete (phasing of system installation/commissioning to be approved by Owner) and ready to be placed into regular service, Contractor shall inform Owner of this fact in writing.
- H. Contractor shall agree on start-up dates with Owner.
- I. On each start-up date for completed portions of the system, Contractor shall have on-site qualified vendor field technicians to place the system in operation, making such tests, adjustments and changes as may be found necessary to insure successful operation of the installed equipment and systems.
- J. Contractor shall notify Owner 24 hours in advance when equipment needs to be shutdown during start-up/testing.
- K. All tests shall be documented by the Contractor and certified, verifying that the tests have been performed and that all deficiencies have been corrected.
 - 1. Contractor shall demonstrate on site to Engineer that each input and output operates as specified, control loops are tuned, alarms report as specified, failsafe modes are as specified, and other verification as requested by Engineer and/or Owner to demonstrate that the system has been checked by the Contractor.
 - 2. All testing must be performed and all deficiencies corrected to Engineer's and Owner's satisfaction.
- L. At the end of each phase of start-up/testing, if equipment and systems are operating in a manner satisfactory to Engineer and Owner, Owner will sign a certificate affirming that the systems operation has been tested and accepted in accordance with the terms of his specification. The date of Owner's final acceptance of the entire system (not phased portions) will be the start of the guarantee period.

3.3 GUARANTEE

- A. Workmanship and material for work specified shall be guaranteed free from defects for a period of twelve (12) months after final completion and acceptance by Owner of the entire system, not portions of the system. Note that warranties for individual controllers placed in service will not commence until the entire system is complete and accepted by Owner. Any equipment herein described that is shown to be defective during the guarantee period shall be adjusted, repaired, or replaced at no charge to Owner.
- B. After the final inspection and demonstration, a punchlist of incomplete or unsatisfactory items will be developed by Engineer.
- C. The Contractor shall respond to the punchlist with a date by which all items will be completed/corrected.
- D. Upon completion of all punchlist items, the Contractor shall inform Engineer in writing of this fact. This date will serve as the tentative guarantee start date.
- E. Upon verification that all punchlist items are complete by the Engineer, the tentative guarantee start date will become the actual guarantee start date.
- F. Items which unreasonably delay the start of the guarantee and are beyond the Contractor's control such as change orders late in the project will not be considered in establishing the guarantee start date.

- G. During the guarantee period, software updates/controller improvements (i.e., microprocessor chip changes) shall be provided to Owner at no charge. Coordinate with Owner prior to the installation of such changes.

Note: The intent of G. is to insure that Owner receives any product updates which are directed toward correcting a product problem which may or may not be apparent. It is not intended to automatically extend to Owner new product features or enhancements which did not exist at the time of Contract Award.

- H. At Owner's request, the Contractor shall visit the building to clarify for the operating personnel any questions as to the proper operation and maintenance of the system during the first year after final acceptance of system.

3.4 CLOSEOUT SUBMITTALS

- A. Refer to Division 01.

3.5 RECORD DOCUMENTS

- A. Refer to Division 01.

3.6 OPERATING AND MAINTENANCE (O & M) MANUALS

- A. Refer to Division 01.
- B. All drawings, applications software and other job documentation will become the property of Owner.

3.7 TRAINING

- A. Contractor shall provide a minimum of two (2) training sessions during the Contract period. Training shall be made available to Owner during multiple working shifts.
- B. The instructor(s) shall be competent and have full knowledge of the system installed and shall provide training specifically oriented to Owner's installed system.
- C. The instructor(s) shall utilize the operating and maintenance manual provided for the system as a reference manual during the training session. Each person attending the training session shall be provided with an O&M manual. At minimum, these sessions shall include the following:
 - 1. Description of the overall control system configuration and physical layout, indicating location of all sensors and controlled devices.
 - 2. Description of all programs and program features (software).
 - 3. Description of the control strategies being utilized at the installation.
 - 4. Description of all key hardware components utilized in the system.
 - 5. Demonstration of how to communicate with (command and monitor) the DDC and ASC Controller(s).
 - 6. Demonstration of the programming instructions required to use the system.
 - 7. Demonstration of how to retrieve alarms and logs.

8. Demonstration of diagnostic trouble shooting techniques for the system.
9. Description of any changes made to existing electric controls which remain.

END OF SECTION

P:\22 Projects\P22-1142-00coev\04 Design\07 Specs\Div 23\23 0900-Basic Temperature Control Requirements.docx

**SECTION 23 0903
TEMPERATURE CONTROL CONDUIT**

PART 1 - GENERAL

1.1 SECTION INCLUDES

- A. Conduit
- B. Connectors
- C. Junction Boxes

1.2 SCOPE

- A. This section includes conduit requirements for use with wire, cable and pneumatic polyethylene tubing.

1.3 SUBMITTALS

Not Applicable

PART 2 - PRODUCTS

2.1 CONDUIT

- A. All wiring shall be installed in a complete conduit raceway system of a minimum trade size of ½". Conduit shall be installed continuous from terminal to terminal and shall be mechanically and electrically connected. The entire system shall be grounded.
 - 1. Exception: With permission of Owner, metallic surface raceway may be used in finished areas on masonry walls. All surface raceway in finished areas must be color matched to the existing finish within the limitations of standard manufactured colors. Receive authorization from Owner before using surface raceway.
 - 2. Exception: The conduit system shall be complete except that up to 12" of exposed Class 2, 3, or communications wiring may be used from the conduit system to an actuator. Wiring extending beyond the conduit system shall be protected by a plastic bushing at the end of the conduit.
- B. Conduit installed outside or exposed to moisture shall be rigid aluminum. Conduit in other areas shall be electric metallic tubing (EMT).
- C. Conduits installed in dry locations requiring flexible connections for adjustment or vibration isolation shall be provided with a 14" maximum length of flexible galvanized steel (Greenfield) conduit. Flexible conduit installed in wet locations and exterior locations shall be liquid-tight type.

2.2 CONNECTORS

- A. Couplings and connectors for use with rigid aluminum shall be the threaded type. Terminations shall be with double locknut and insulated bushings. Fittings installed outdoors shall be water tight.
- B. Couplings and connectors for electrical metallic tubing (EMT) shall be gland compression.

2.3 JUNCTION BOXES AND PULL BOXES

- A. Provide junction boxes and pull boxes of the proper size and shape.
- B. Junction and pull boxes shall be supported independently of the conduit system.

- C. Junction and pull boxes shall be of galvanized steel construction.
- D. Mark each junction box cover using permanent marker to indicate that wiring enclosed is associated with the controls system.

PART 3 - EXECUTION

3.1 CONDUIT INSTALLATION

- A. Conduit shall not be smaller than the sizes indicated or specified, and where no size is indicated, the Contractor shall size the conduit in accordance with the requirements of the local/state Electrical Code for the number, size and type of wires indicated and specified for application, except that no conduit shall be less than ½" trade size.
- B. Where conduit enters panel boxes, pull boxes, outlet boxes or wireways, it shall be secured in place by galvanized locknut on the outside and galvanized locknut and bushing on the inside. Bushing shall be insulated throat type with ground lug. Care shall be taken to see that all conduit runs from a permanent and continuous ground return back to the panel ground connection point. All bushings shall be bonded to the junction box, outlet box, cabinet, etc. Where required, bonding jumpers shall be installed between conduit and boxes.
- C. Conduits for branch circuits shall be installed continuous between connections to outlets, boxes and cabinets and shall have a minimum possible number of bends or fittings. Bends shall be made with an approved hickey or conduit-bending machine and shall be smooth and even without flattening or flaking.
- D. Exposed conduit runs shall be run neatly and shall be parallel to the walls of the building.
- E. The actual installation of conduit shall be made in the field to clear all piping, ductwork, equipment fixtures, ceiling inserts, access doors, etc. Bends, turns, and pull boxes, as required, shall be provided in accordance with field conditions.
- F. Conduit ends shall be reamed and shall be thoroughly cleaned before installation. Conduit openings and boxes shall be plugged or covered as required to keep conduit clean during construction. All conduit shall be swabbed clear of obstructions before the pulling of wires.
- G. All threaded joints in rigid aluminum conduit shall be sealed with Thomas & Betts "Alum-Shield" compound on the male thread only.
- H. Conduit runs shall be securely fastened in place with approved straps, and hangers and supports from inserts set in the construction above. Vertical conduit shall be securely clamped to steel members and unistruts, and attached to the structure.
- I. Conduit shall not pierce or interfere with waterproofing, vapor barriers, damp-proofing, etc.
- J. Raceways run through foundation walls, basement slabs, or through any walls for floors that have vapor barriers, waterproofing, or any type of damp-proofing, shall be sealed by use of special wall and floor entrance seals designed for the purpose. Drawings of the proposed seals and clamping arrangements shall be submitted for approval.
- K. Conduits passing from the building exterior to interior or passing between conditioned and non-conditioned spaces shall be sealed to prevent condensation in the conduit.
- L. Conduits crossing building expansion joints shall be provided with expansion fittings and flexible grounded bonds bypassing the fittings to insure ground continuity.

- M. All conduit shall be supported with fasteners designed for the application and must be attached to the building structure and shall not be supported from other conduit, pipes, ductwork, ceiling suspension members or equipment. Existing pipe hangers for multiple conduits with spare capacity may be used.
 - 1. Exception: When conduit is required to terminate at a sensor or control point on ductwork, the conduit may be fastened to the ductwork. This is the only condition in which conduit is allowed to be fastened to ductwork.
 - 2. Note: Perforated metal strap and tie wire are prohibited.
- N. Existing conduit which is in place and has additional wire carrying capacity due to existing wiring being removed or due to original spare capacity may be used for new wiring if the conduit installation meets this Temperature Control conduit specification.
- O. All openings for conduit passing through masonry walls or floor shall be core drilled by this Contractor. Core holes shall be sealed as follows:
 - 1. For the conduits penetrating floor or fire walls, the Contractor shall provide fire stopping equivalent to the construction penetrated.
 - 2. Where conduit passes through floor or exterior walls, caulk at both sides to insure waterproofing around conduit.
 - 3. Where conduit penetrates walls separating quiet areas such as offices from noisy areas such as equipment rooms, the opening around the conduit shall be filled with fiberglass insulation and sealed.

3.2 JUNCTION BOX INSTALLATION

- A. All outlets shall be installed in accessible locations and none shall be installed above ducts, behind furring or in other similar locations. Any outlet designated as providing power for particular piece of equipment shall be accessible for disconnection with said unit in place.

END OF SECTION

P:\22 Projects\142-00coev\04 Design\07 Specs\Div 23\23 0903-Temperature Control Conduit.docx

**SECTION 23 0904
TEMPERATURE CONTROL WIRING**

PART 1 - GENERAL

1.1 SECTION INCLUDES

- A. Wire
- B. Cable

1.2 SCOPE

- A. Power wiring, Class 1, 2, or 3 wiring, and communications wiring required for satisfactory installation and operation of all equipment specified under temperature control shall be furnished and installed by this contractor.
- B. Wiring shall be installed in accordance to wiring specification found in this section.
- C. All wiring shall be UL listed and installed in accordance with applicable electrical codes and shall comply with equipment manufacturer's recommendations.

Note: When specified materials or installation methods exceed applicable electrical codes and equipment manufacturer's recommendations, this specification shall govern.

1.3 SUBMITTALS

- A. Submit data and samples of the following:
 - 1. Analog Cable
 - 2. Other low voltage signal cable

PART 2 - PRODUCTS

2.1 WIRE AND CABLE

- A. All wires shall be copper and shall meet the minimum wire size and insulation class listed.

WIRE CLASS	MINIMUM WIRE SIZE	MINIMUM INSULATION CLASS
Power	12 Gauge	600 Volt
Class 1	14 Gauge Stranded	600 Volt
Class 2	18 Gauge Stranded	300 Volt
Class 3	18 Gauge Stranded	300 Volt
Communications	Per Manufacturer	Per Manufacturer

- B. 120V power circuit wiring shall be #12 AWG. Home runs longer than 100 feet shall be #10 AWG.
- C. 24V control power circuit wiring and all wiring to flow switches and relays shall be #14 AWG. Runs greater than 200 feet in length shall be #12 AWG.
- D. Use twisted shielded pair, insulated and jacketed cable, #18 AWG minimum, for wiring to sensors (temperature, humidity, etc.). All sensor wiring shall have a 100% grounded shield.
- E. Network communications wiring shall be in accordance with manufacturer's specifications.

- F. Use THHN wires for power circuit wiring and all control wiring in dry locations; use THWN wires for wet locations.
- G. Conductors shall be continuous from outlet to outlet and no splices or connections shall be made, except within outlet boxes, junction boxes or cabinets.
- H. Permanent wiring shall not be pulled into conduits or raceways until permission is granted by Owner.
- I. Where the space above a ceiling is a supply or return air plenum, the wiring therein shall be plenum rated.

PART 3 - EXECUTION

3.1 WIRING

- A. All sensor wiring shall use crimped or soldered connections; wire nuts are not allowed.
- B. Sensor wiring shall be continuous containing no splices between the digital controller and the field sensor.
- C. Identify all control/signal wires with labeling tape using either words, letters or numbers that can be exactly cross-referenced with as-built drawings.

3.2 INSTALLATION

- A. Wires shall be kept a minimum of 3" from hot water piping, steam piping, condensate piping or any other hot surfaces.
- B. The Contractor shall provide a separate insulated green ground wire inside each power branch circuit conduit. Connect one end of the ground wire to the ground bus or ground terminal in the panel board. Connect the other end of the ground wire to the grounding lug in equipment being served. Provide and install a grounding lug in equipment being served if no grounding lug exists.
- C. Identify all temperature control raceways with labels stating "Control System Wiring." Typed (not handwritten) labels shall be affixed to the covers of all junction boxes and pull boxes.

3.3 RACEWAY SYSTEM

- A. Power and Class 1 wiring may be run in the same conduit. Class 2 and 3 wiring and communications wiring may be run in the same conduit. Power and Class 1 may not be run together with Class 2, Class 3, or communications wiring.
- B. No sensor wiring shall be run in the same conduit with power or Class 1 wiring.
- C. Where different wiring classes terminate within the same enclosures, maintain clearances and install barriers per National Electric Code.
- D. Pneumatic tubing may not be run in wiring conduit.
- E. Wiring within air handling units shall be in a complete conduit system.

END OF SECTION

P:\22 Projects\P22-1142-00coev\04 Design\07 Specs\Div 23\23 0904-Temperature Control Wiring.docx

SECTION 23 0906
TEMPERATURE CONTROL DEMOLITION

PART 1 - GENERAL

1.1 SECTION INCLUDES

- A. Miscellaneous Existing Controls
- B. Demolition of Controls

1.2 SCOPE

- A. Demolition of DDC and pneumatic control panels, devices and associated wiring, tubing and conduit for mechanical systems specified in this section.

1.3 SUBMITTALS

Not Applicable

PART 2 - PRODUCTS

Not Applicable

PART 3 - EXECUTION

3.1 MISCELLANEOUS EXISTING CONTROLS

- A. Existing control equipment that is to remain is to be calibrated/adjusted for proper operation.
- B. Any equipment found to be defective and requiring replacement shall be brought to the attention of Owner. Owner will be responsible for repairs to same.
- C. Existing control equipment that is to remain shall be relocated to a new enclosure.

3.2 DEMOLITION

- A. Demolition of the existing control systems shall be limited to those systems in which the temperature controls are to be replaced by this Project.
- B. Demolition shall include removal of all existing direct digital controls, electric controls, and pneumatic controls not specifically identified to remain. This includes but is not limited to:
 - 1. Field control panels
 - 2. Temperature control panels
 - 3. Pneumatic/electric controls associated with mechanical systems equipment
 - 4. Pneumatic tubing
 - 5. Electric devices, wiring and conduit
 - a. **Note:** Abandoned tubing and wiring, including conduit, shall be removed completely except where tubing or conduit are installed in inaccessible locations, such as within walls or floors. All tubing ends shall be capped. Above drop ceilings is considered to be inaccessible except that wiring and pneumatic tubing within or outside conduit is to be pulled out. Conduit is to remain in place.
- C. Demolition of temperature control panels includes removal of all associated wiring.

- D. Owner will inform the Contractor of any equipment to be removed that will remain the property of Owner. All other equipment removed shall be disposed of by the Contractor.
- E. The Contractor shall insure that removed controls do not compromise the operation of the existing controls which remain.
- F. The Contractor shall be required to make minor modifications to the existing control system such that when a portion of a control system is removed, the remaining system is left in a neat and orderly condition similar to the original installation.
 - 1. It is the intent of this project to eliminate existing DDC, electric, and pneumatic control panels where much of the internal equipment is no longer needed. Consolidate equipment that is to remain into one new field panel.
 - 2. Caution is necessary in this consolidation/clean-up mode, since there is potential for existing wiring which passes through these panels and does not terminate at the panel.
 - a. Where control panels, once so demolished of controls, devices, etc., render the remaining function of the panel to be a junction box or pull box, Contractor shall so remove the control panel and install a junction box and necessary conduit, where allowed by code.
 - b. Contractor shall maintain all fire and smoke control system interlocks on units where such exists.
- G. Patch and seal any holes left in ductwork, walls, etc. after the existing controls have been removed. A stainless or Owner-approved equal cover plate may be used in finished spaces.
- H. Temporary work necessary to maintain air flow, space temperature and relative humidity during demolition of existing controls shall be provided by this Contractor.

END OF SECTION

P:\22 Projects\P22-1142-00coev\04 Design\07 Specs\Div 23\23 0906-Temperature Control Demolition.docx

**SECTION 23 0911
CONTROL VALVES**

PART 1 - GENERAL

1.1 SCOPE OF WORK

- A. Critical application butterfly style control valves
- B. Valve actuators

1.2 DEFINITIONS

- A. Cv: Design valve coefficient
- B. DDC: Direct digital control
- C. I/O: Input/output
- D. NBR: Nitrile butadiene rubber
- E. PICV: Pressure independent control valve
- F. PTFE: Polytetrafluoroethylene
- G. Rangeability: The ratio of the maximum to minimum controllable flow through a valve
- H. RMS: Root-mean-square value of alternating voltage, which is the square root of the mean value of the square of the voltage values during a complete cycle.

1.3 CODES AND STANDARDS (USE LATEST EDITION)

- A. American Society of Mechanical Engineers (ASME)
 - 1. ASME B1.20.1: Pipe Threads, General Purpose, Inch
 - 2. ASME B16.1: Cast Iron Pipe Flanges and Flanged Fittings
 - 3. ASME B16.4: Cast Iron Threaded Fittings
 - 4. ASME B16.5: Pipe Flanges and Flanged Fittings, NPS1/2 to NPS24
 - 5. ASME B16.10: Face-to-Face and End-to-End Dimensions of Valves
 - 6. ASME B16.15: Cast Bronze Threaded Fittings.
 - 7. ASME B16.18: Cast Copper Alloy Solder Joint Pressure Fittings.
 - 8. ASME B16.21: Nonmetallic Flat Gaskets for Pipes Flanges
 - 9. ASME B16.22: Wrought Copper and Copper Alloy Solder Joint Pressure Fittings
 - 10. ASME B16.24: Bronze Flanges and Flanged Fittings.
 - 11. ASME B16.34: Valves – Flanged, Threaded and Welding End
 - 12. ASME B18.2.1: Square and Hex Bolts and Screws - Inch Series
- B. American Society for Testing Materials (ASTM)
 - 1. ASTM A 126: Specification for Gray Iron Castings for Valves, Flanges, and Pipe Fittings
 - 2. ASTM B 61: Specification for Steam or Valve Bronze Castings

- C. American Water Works Association (AWWA)
 - 1. AWWA C606: Grooved and Shouldered Joints
- D. Brazing Handbook.
- E. Copper Tube Handbook.
- F. Manufacturers Standardization Society (MSS)
 - 1. MSS SP-67: Butterfly Valves

1.4 QUALITY ASSURANCE

- A. This Section establishes a minimum quality of hardware and installation and establishes standard equipment or equipment configurations.
- B. Work installed by the Contractor shall be done in a neat and workmanlike manner, as determined by Owner and in keeping with acceptable standards for this type of work.
- C. Unless indicated in this specification, all materials used shall be new. Where items have been indicated to be reused, it is the Contractor's responsibility to ensure that the reused items are operating properly and are in good condition. Contractor must make Owner aware of defective items designated for reuse. The owner will be responsible for repairs.

1.5 SUBMITTALS

- A. Preconstruction – Prior to construction provide the following in accordance with Specification 20 0500 – Basic Requirements for Mechanical, Plumbing, and Fire Suppression:
 - 1. Product Data:
 - a. Construction details, material descriptions, dimensions of individual components and profiles, and finishes.
 - b. Operating characteristics, electrical characteristics, and furnished accessories indicating process operating range, accuracy over range, control signal over range, default control signal with loss of power, calibration data specific to each unique application, electrical power requirements, and limitations of ambient operating environment, including temperature and humidity.
 - c. Product description with complete technical data, performance curves, and product specification sheets.
 - d. Installation, operation, and maintenance instructions, including factors affecting performance.
 - e. Submit manufacturer's technical literature for each control device listed below. Indicate dimensions, capacities, performance characteristics, electrical characteristics, finishes for materials, and installation and startup instructions, and bill of materials indicating quantity of each device, and model number:
 - f. Include details of product assemblies. Indicate dimensions, weights, loads, required clearances, method of field assembly, components, and location and size of each field connection.
 - g. Include diagrams for power, signal, and control wiring.
 - h. Include diagrams for pneumatic signal and main air tubing.

2. Control Valve Schedule: Control valve selections shall be based on equipment flow rates shown in the approved equipment shop drawings. The contractor shall size the control valves and create a valve schedule that includes, at a minimum, the following:
 - a. Valve tag
 - b. Location (e.g. 1st floor mechanical room)
 - c. Service (e.g. chilled water, hot water)
 - d. Valve type (e.g. globe, ball, butterfly)
 - e. Flow characteristics
 - f. Valve size
 - g. Pipe size
 - h. Flow at project design and minimum flow conditions.
 - i. Valve CV
 - j. Rangeability
 - k. Pressure drop at design flow
 - l. Close-off pressure
 - m. Fail position
 - n. Actuator type
 - o. Valve and actuator model numbers
 3. Manufacturer's installation and operating manuals.
- B. Contract Closeout – At contract closeout provide the following in accordance with Specification 20 0500 – Basic Requirements for Mechanical, Plumbing, and Fire Suppression:
1. Operating and Maintenance Data including:
 - a. Product data
 - b. Installation instructions
 - c. Assembly drawings
 - d. Replacement parts list
 - e. Maintenance and operation instructions
 2. Test Reports
 - a. Acceptance Test
 3. Warranties

1.6 DELIVERY, STORAGE AND HANDLING

- A. Deliver products to site under provisions of Division 1.
- B. Deliver products to site in containers with manufacturer's stamp affixed.
- C. Protect products against dirt, water, chemical and mechanical damage before, during and after installation. Damage to products prior to final acceptance of the Work shall be repaired or replaced at no additional cost to the Owner.

1.7 SPARE PARTS

Not Applicable

1.8 WARRANTY

- A. One year warranty on products and complete installation commencing at the time of Substantial Completion.

1.9 MAINTENANCE

Not Applicable

PART 2 - PRODUCTS

2.1 BUTTERFLY STYLE CONTROL VALVES

- A. Acceptable Manufacturers
 - 1. Bray
 - 2. Fisher
 - 3. Keystone
 - 4. Powell Valve
- B. Construction
 - 1. Body: ANSI Class 150 one-piece fully lugged carbon steel body with extended neck.
 - 2. Disc: Hand polished 316 stainless steel
 - 3. Stem: One-piece blow-out proof 17-4 PH stainless steel stem, top and bottom stem bearings with 316 stainless steel shells with TFE/glass fabric bearing surface.
 - 4. Seat: RTFE with silicone rubber energizer.
 - 5. Connections: Flanged.
- C. Two-way Operation
 - 1. Flow Characteristic: Linear, unidirectional dead end service.
 - 2. Leakage: Bubble-tight shutoff (no leakage) to 285 psi.
 - 3. Rangeability: Minimum 33:1

2.2 VALVE ACTUATORS

- A. Electronic Actuators
 - 1. Acceptable Manufacturers
 - a. Belimo
 - b. Siemens
 - 2. Electric type with reversing switch and gear disengagement button on cover.
 - 3. Direct-coupled type designed for minimum 60,000 full-stroke cycles at rated torque.
 - 4. Size for torque required to close valve against pump shutoff head.
 - 5. Microprocessor-controlled brushless DC motor.
 - 6. Overload Protection
 - a. Provide against overload throughout the entire operating range in both directions.

- b. Electronic overload, digital rotation sensing circuitry, mechanical end switches, or magnetic clutches are acceptable methods of protection.
- 7. Temperature: Suitable for operating temperature range encountered by application with minimum operating temperature range of -20°F - 150°F.
- 8. Humidity: Suitable for humidity range encountered by application with minimum operating range of 5% - 95% relative humidity, non-condensing.
- 9. Enclosure
 - a. Suitable for ambient conditions encountered by application
 - b. NEMA 250 Type 2/IP54 enclosure for indoor and protected applications.
 - c. NEMA Type 4/IP66 enclosure for outdoor and unprotected applications.
 - d. Provide actuator enclosure with heater, controller, and self-contained thermostat where required by application.
- 10. Power Supply
 - a. 24V or 120V.
 - b. Actuator shall deliver torque required for continuous uniform movement of controlled device from limit to limit when operated at rated voltage.
 - c. Actuator shall function properly within a range of 85%-120% of nameplate voltage.
- 11. Rotation Limitation: Provide angle of rotation limiter capable of setting the valve position to less than 100% open or 100% closed.
- 12. Stroke Time:
 - a. Except where indicated otherwise on drawings, operate the valve from fully closed to fully open and vice versa within 90 seconds.
 - b. For spring return actuators move valve to failed position within 25 seconds.
- 13. Spring Return Electronic Actuators
 - a. Modulating
 - (1) Capable of stopping at all points across full range and starting in either direction from any point in range.
 - (2) Proportional Control: 4-20mA or 0-10Vdc input signal to modulate the actuator proportionally throughout its angle of rotation.
 - b. Two Position
 - (1) Single direction, spring return type
 - (2) Digital input signal to modulate the actuator to its open or closed position.
 - c. Fail Safe
 - (1) Spring-return mechanical fail safe mechanism to drive controlled devices to an end position upon loss of power.
 - (2) External manual gear release.
 - (3) Field adjustable from fail open to fail closed without replacement.
 - d. Position Feedback
 - (1) Provide a position indicator and graduated scale on each actuator indicating open and closed travel limits.

14. Non-Spring Return Electronic Actuators
 - a. Modulating
 - (1) Capable of stopping at all points across full range and starting in either direction from any point in range.
 - (2) Floating Point: Coordinated digital input signals to modulate the actuator throughout its angle of rotation.
 - b. Two Position
 - (1) On/off type.
 - (2) Digital input signal to modulate the actuator to its open or closed position.
 - c. Position Feedback
 - (1) Provide a position indicator and graduated scale on each actuator indicating open and closed travel limits.
 - d. Fail Safe
 - (1) Actuators shall be configured to fail at the "last position".
 - (2) External manual gear release.

B. Industrial Electronic Actuators

1. Acceptable Manufacturers
 - a. Bray (Series 70)
 - b. Keystone (EPI-2)
2. Size for torque required to close valve against pump shutoff head.
3. Single phase permanent split-capacitor reversible motor with Class F or better insulation, and built-in thermal overload protector with automatic reset.
4. Provide against overload throughout the entire operating range in both directions.
5. Actuator shall be continuous duty rated for 100% modulating operation at 104°F ambient temperature.
6. Temperature: Suitable for operating temperature range encountered by application with minimum operating temperature range of -20°F - 150°F.
7. Humidity: Suitable for humidity range encountered by application with minimum operating range of 5%-95% relative humidity, non-condensing.
8. Enclosure: NEMA Type 4/IP65 enclosure with visual position status indicator and internal heater with controller and self-contained thermostat.
9. Power Supply
 - a. 24V or 120V.
 - b. Actuator shall deliver torque required for continuous uniform movement of controlled device from limit to limit when operated at rated voltage.
 - c. Actuator shall function properly within a range of 85% - 120% of nameplate voltage.
10. Rotation Limitation: Provide angle of rotation limiter capable of setting the valve position to less than 100% open or 100% closed.

11. Stroke Time:
 - a. Except where indicated otherwise on drawings, operate the valve from fully closed to fully open and vice versa within 90 seconds.
 - b. For spring return actuators move valve to failed position within 25 seconds.
12. Control Type
 - a. Modulating
 - (1) Capable of stopping at all points across full range and starting in either direction from any point in range.
 - (2) Control Signal: Proportional Control: 4-20mA or 0-10Vdc input signal to modulate the actuator proportionally throughout its angle of rotation.
 - b. Two Position
 - (1) On/off type.
 - (2) Control Signal: Digital input signal to modulate the actuator to its open or closed position.
13. Position Feedback
 - a. Provide a position indicator and graduated scale on each actuator indicating open and closed travel limits.
 - b. Provide auxiliary switches for positive means of position indication signal for remote monitoring of open and closed position.
14. Fail Safe
 - a. External manual gear release.

PART 3 - EXECUTION

3.1 EXAMINATION

- A. Examine substrates and conditions for compliance with requirements for installation tolerances and other conditions affecting performance of the Work.
- B. Examine roughing-in for valves installed in piping to verify actual locations of piping connections before installation.
- C. Prepare written report listing conditions detrimental to performance.
- D. Proceed with installation only after unsatisfactory conditions have been corrected.

3.2 APPLICATION

- A. Install control valves per the following table:

PIPING SYSTEM AND LOCATION	VALVE TYPE	ACTUATOR TYPE
Hot water valves at boilers, heat exchangers, and other central plant equipment: Two-Position	Butterfly Type	Industrial electronic

- B. Refer to drawings for identification of requirements for modulating or two-position actuators.
- C. Refer to drawings for identification of spring return (normally open/normally closed) or floating actuators (fail last position).

3.3 SIZING

- A. Control valves shall be sized to provide a pressure drop:
 - 1. Two-position: Line size or size using a pressure differential of 1 psi.
- B. Hydronic valve actuators shall be sized for torque required to close valve against pump shutoff head.

3.4 INSTALLATION

- A. Furnish and install products required to satisfy most stringent requirements indicated.
- B. Install products level, plumb, parallel, and perpendicular with building construction.
- C. Properly support instruments, tubing, piping, wiring, and conduits to comply with requirements indicated. Brace all products to prevent lateral movement and sway or a break in attachment.
- D. Install products in locations that are accessible and that will permit calibration and maintenance from floor, equipment platforms, or catwalks. Where ladders are required for Owner's access, confirm unrestricted ladder placement is possible under occupied condition.
- E. Install pipe reducers for valves smaller than line size. Position reducers as close to valve as possible but at distance to avoid interference and impact to performance. Install with manufacturer-recommended clearance.
- F. Install flanges or unions to allow drop-in and -out valve installation.
- G. Valve Orientation:
 - 1. Where possible, install globe and ball valves installed in horizontal piping with stems upright and not more than 15° off of vertical, not inverted.
 - 2. Install valves in a position to allow full stem movement.
 - 3. Where possible, install butterfly valves that are installed in horizontal piping with stems in horizontal position and with low point of disc opening with direction of flow.
- H. Clearance:
 - 1. Locate valves for easy access and provide separate support of valves that cannot be handled by service personnel without hoisting mechanism.
 - 2. Install valves with at least 12 inches (300 mm) of clear space around valve and between valves and adjacent surfaces.
- I. Flanged Valves:
 - 1. Align flange surfaces parallel.
 - 2. Assemble joints by sequencing bolt tightening to make initial contact of flanges and gaskets as flat and parallel as possible. Use suitable lubricants on bolt threads. Tighten bolts gradually and uniformly with a torque wrench.
- J. Electrical Power:
 - 1. Furnish and install electrical power to products requiring electrical connections.
 - 2. Furnish and install circuit breakers where required. Comply with requirements in Division 26 Specifications.
 - 3. Furnish and install wiring and raceways.

4. Connect electrical devices and components to electrical grounding system. Comply with requirements in Division 26 Specifications.
- K. Provide individual valve tagging of up to 30 characters (location/service/unit, etc.).
- L. Cleaning: Remove grease, mastic, adhesives, dust, dirt, stains, fingerprints, labels, and other foreign materials from exposed interior and exterior surfaces. Polish glossy surfaces to a clean shine.

3.5 CHECKOUT PROCEDURES

- A. Check installed products before continuity tests, leak tests, and calibration.
- B. Check valves for proper location and accessibility.
- C. Check valves for proper installation for direction of flow, elevation, orientation, insertion depth, or other applicable considerations that will impact performance.
- D. Verify that control valves are installed correctly for flow direction.
- E. Verify that valve body attachment is properly secured and sealed.
- F. Verify that valve actuator and linkage attachment are secure.
- G. Verify that actuator wiring is complete, enclosed, and connected to correct power source.
- H. Verify that valve ball, disc, and plug travel are unobstructed.
- I. After piping systems have been tested and put into service, but before insulating and balancing, inspect each valve for leaks. Adjust or replace packing to stop leaks. Replace the valve if leaks persist.

3.6 TESTING

- A. Acceptance Test
 1. Stroke and adjust control valves following manufacturer's recommended procedure, from 100% open to 100% closed back to 100% open.
 2. Stroke control valves with pilot positioners. Adjust valve and positioner following manufacturer's recommended procedure, so valve is 100% closed, 50% closed, and 100% open at proper air pressures.
 3. Check and document open and close cycle times for applications with a cycle time of less than 30 seconds.
 4. For control valves equipped with positive position indication, check feedback signal at multiple positions to confirm proper position indication.
 5. Provide test result report within two weeks of testing indicating completion of the Acceptance Test for each control valve.

END OF SECTION

P:\22 Projects\P22-1142-00coev\04 Design\07 Specs\Div 23\23 0911-Control Valves.docx

**SECTION 23 0912
CONTROL DAMPERS**

PART 1 - GENERAL

1.1 SCOPE OF WORK

- A. Rectangular control dampers
- B. Round control dampers
- C. Damper actuators

1.2 DEFINITIONS

Not Applicable

1.3 CODES AND STANDARDS (UTILIZE LATEST EDITION)

- A. Air Movement and Control Associates International (AMCA)
 - 1. AMCA 500: Test Methods for Louvers, Dampers and Shutters
 - 2. AMCA 511: Certified Ratings Program for Air Control Devices
- B. National Fire Protection Association (NFPA)
 - 1. NFPA 90A: Installation of Air Conditioning and Ventilating Systems
- C. Sheet Metal and Air Conditioning Contractors' National Association (SMACNA)
 - 1. SMACNA: HVAC Duct Construction Standards-Metal and Flexible

1.4 QUALITY ASSURANCE

- A. Source Limitations: All control dampers for this project shall be obtained from a single manufacturer.
- B. Comply with NFPA 90A, "Installation of Air Conditioning and Ventilating Systems."
- C. Control dampers shall be designed and manufactured to conform to the same pressure class as the duct in which they are located, unless otherwise indicated to exceed.

1.5 SUBMITTALS

- A. Preconstruction – Prior to construction provide the following in accordance with Specification 20 0500 – Basic Requirements for Mechanical, Plumbing, and Fire Suppression:
 - 1. Product Data: For each type of product, including the following:
 - a. Construction details, material descriptions, dimensions of individual components and profiles, and finishes.
 - b. Operating characteristics, electrical characteristics, and furnished accessories indicating process operating range, accuracy over range, control signal over range, default control signal with loss of power, calibration data specific to each unique application, electrical power requirements, and limitations of ambient operating environment, including temperature and humidity.
 - c. Product description with complete technical data, performance curves, and product specification sheets.
 - d. Installation instructions, including factors affecting performance.

- e. Include plans, elevations, sections, and mounting details.
 - f. Include details of product assemblies. Indicate dimensions, weights, loads, required clearances, method of field assembly, components, and location and size of each field connection.
 - g. Include diagrams for power, signal, and control wiring.
2. Control Damper Schedule: Control damper selections shall be based on equipment flow rates shown in the approved equipment shop drawings. The contractor shall size the control dampers and create a damper schedule that includes, at a minimum, the following:
 - a. Damper tag
 - b. Location (e.g. 1st floor mechanical room)
 - c. Service (e.g. AHU-1 supply, Isolation Exhaust)
 - d. Damper type (e.g. opposed blade, parallel blade)
 - e. Damper size
 - f. Actuator torque
 - g. Flow at project design and minimum flow conditions.
 - h. Pressure drop at design flow
 - i. Fail position
 - j. Actuator type
 - k. Damper and actuator model numbers
 3. Manufacturer's installation and operating manuals.
- B. Contract Closeout – At contract closeout provide the following in accordance with Specification 20 0500 – Basic Requirements for Mechanical, Plumbing, and Fire Suppression:
1. Operating and Maintenance Data including:
 - a. Product data
 - b. Installation instructions
 - c. Assembly drawings
 - d. Replacement parts list
 - e. Maintenance and operation instructions
 2. Test Reports
 - a. Acceptance Test
 3. Warranties

1.6 DELIVERY, STORAGE AND HANDLING

- A. Deliver products to site under provisions of Division 1.
- B. Deliver products to site in containers with manufacturer's stamp affixed.
- C. Protect products against dirt, water, chemical and mechanical damage before, during and after installation. Damage to products prior to final acceptance of the Work shall be repaired or replaced at no additional cost to the Owner.

1.7 SPARE PARTS

Not Applicable

1.8 WARRANTY

- A. One year warranty on products and complete installation commencing at the time of Substantial Completion.

1.9 MAINTENANCE

Not Applicable

PART 2 - PRODUCTS

2.1 RECTANGULAR CONTROL DAMPERS

- A. Acceptable Manufacturers
 - 1. Air Balance, Inc.
 - 2. Johnson Controls
 - 3. Ruskin Company
 - 4. TAMCO
 - 5. Vent Products Company, Inc.
 - 6. Greenheck
- B. General
 - 1. Factory assemble multiple damper sections to provide a single damper assembly of size required by the application.
 - 2. Include leakage, leakage class, pressure drop, maximum pressure, and AMCA certification data in submittals.
- C. Construction
 - 1. Frame:
 - a. Material: ASTM B 211, Alloy 6063-T5 extruded aluminum, minimum 0.07 inch thick.
 - b. Hat-shaped channel with integral flange reinforced at corners. Mating face shall be minimum of 1 inch.
 - c. Width not less than 5 inches
 - 2. Blades:
 - a. Material: ASTM B211, Alloy 6063-T5 aluminum, minimum 0.07 inch thick.
 - b. Standard duty dampers shall be hollow extruded aluminum airfoil profile with press fitted aluminum blade end caps.
 - c. Maximum 6 inches wide
 - d. Length as required by close-off pressure, not to exceed 48 inches.
 - 3. Seals:
 - a. Blade: Replaceable, mechanically attached extruded silicone, vinyl, or plastic composite.
 - b. Frame: Stainless steel compression or replaceable, mechanically attached extruded silicone, vinyl, or plastic composite.
 - 4. Axles: Minimum 7/16" adjustable hex-shaped plated steel, mechanically attached to the damper blades.

5. Bearings
 - a. Molded synthetic or stainless-steel sleeve mounted in frame.
 - b. Where blade axles are installed in vertical position, provide thrust bearings.
 6. Linkage
 - a. Concealed in frame.
 - b. Constructed of aluminum, galvanized steel or stainless steel.
 - c. Hardware: Stainless steel
- D. Performance
1. Leakage
 - a. 1 inch w.g.: AMCA 500, Class 1A. Leakage shall not exceed 3 cfm/sq. ft.
 - b. 4 inch w.g.: AMCA 500, Class 1. Leakage shall not exceed 8 cfm/sq. ft.
 2. Certification: Damper shall have the AMCA seal for both air leakage and air performance.
 3. Pressure Drop: Maximum 0.03 inch w.g. at 1,500 fpm across a 24" x 24" damper.
 4. Capacity:
 - a. Closed Position: Maximum pressure of 13 inches w.g. at a 12 inch blade length.
 - b. Open Position: Maximum air velocity of 6,000 fpm.
 5. Temperature: -40°F-185°F
- E. Basis of Design
1. Standard Dampers: Ruskin CD-50, Tamco 1500

2.2 DAMPER ACTUATORS

- A. Acceptable Manufacturers
 1. Belimo
 2. Johnson Controls
 3. Siemens
 4. Honeywell
- B. Direct-coupled type designed for minimum 60,000 full-stroke cycles at rated torque.
- C. Size for torque required for damper seal at maximum design conditions.
- D. Microprocessor-controlled brushless DC motor.
- E. Overload Protection
 1. Provide against overload throughout the entire operating range in both directions.
 2. Electronic overload, digital rotation sensing circuitry, mechanical end stiches, or magnetic clutches are acceptable methods of protection.
- F. Damper Attachment
 1. Unless otherwise required for damper interface, provide actuator designed to be directly coupled to damper shaft without need for connecting linkages.

2. Attach actuator to damper drive shaft in a way that ensures maximum transfer of power and torque without slippage.
 3. Bolt and set screw method of attachment is acceptable only if provided with at least two points of attachment.
- G. Temperature: Suitable for operating temperature range encountered by application with minimum operating temperature range of -20°F-120°F.
- H. Humidity: Suitable for humidity range encountered by application with minimum operating range of 5%-95% relative humidity, non-condensing.
- I. Enclosure
1. Suitable for ambient conditions encountered by application
 2. NEMA 250 Type 2/IP54 enclosure for indoor and protected applications.
 3. NEMA Type 4/IP66 enclosure for outdoor and unprotected applications.
 4. Provide actuator enclosure with heater and controller where required by application.
- J. Power Supply
1. 24V or 120V.
 2. Actuator shall deliver torque required for continuous uniform movement of controlled device from limit to limit when operated at rated voltage.
 3. Actuator shall function properly within a range of 85%-120% of nameplate voltage.
- K. Rotation Limitation: Provide angle of rotation limiter capable of setting the damper position to less than 100% open or 100% closed.
- L. Spring Return Electronic Actuators
1. Modulating: Capable of stopping at all points across full range, and starting in either direction from any point in range.
 2. Two Position: Single direction, spring return type
 3. Fail Safe
 - a. Spring-return mechanical fail safe mechanism to drive controlled devices to an end position upon loss of power.
 - b. Field adjustable from fail open to fail closed without replacement.
 4. Position Feedback
 - a. Provide a position indicator and graduated scale on each actuator indicating open and closed travel limits.
 - b. Provide auxiliary switches for positive means of position indication signal for remote monitoring of open and closed position.
 - c. Provide a 4-20mA or 0-10Vdc position feedback signal for remote monitoring of modulating actuators.
 5. Control Type
 - a. Modulating: Proportional Control: 4-20mA or 0-10Vdc input signal to modulate the actuator proportionally throughout its angle of rotation.

- b. Two-Position Control: Digital input signal to modulate the actuator to its open or closed position.

M. Non-Spring Return Electronic Actuators

1. Modulating: Capable of stopping at all points across full range, and starting in either direction from any point in range.
2. Two Position: On/off type.
3. Position Feedback
 - a. Provide a position indicator and graduated scale on each actuator indicating open and closed travel limits.
 - b. Provide auxiliary switches for positive means of position indication signal for remote monitoring of open and closed position.
 - c. Provide a 4-20mA or 0-10Vdc position feedback signal for remote monitoring of modulating actuators.
4. Fail Safe
 - a. External manual gear release.
5. Control Type
 - a. Modulating:
 - (1) Proportional Control: 4-20mA or 0-10Vdc input signal to modulate the actuator proportionally throughout its angle of rotation.
 - b. Two-Position Control: Digital input signal to modulate the actuator to its open or closed position.

N. Electronic Fail Safe Actuators

1. Modulating: Capable of stopping at all points across full range, and starting in either direction from any point in range.
2. Two Position: On/off type.
3. Position Feedback
 - a. Provide a position indicator and graduated scale on each actuator indicating open and closed travel limits.
 - b. Provide auxiliary switches for positive means of position indication signal for remote monitoring of open and closed position.
 - c. Provide a 4-20mA or 0-10Vdc position feedback signal for remote monitoring of modulating actuators.
4. Fail Safe
 - a. Electronic fail safe system to drive controlled devices to an end position upon loss of power.
 - b. Field adjustable from fail open to fail closed without replacement.
 - c. Fail safe status shall be indicated visually on the face of the actuator.
 - d. The fail position shall be adjustable between 0 to 100% in 10° increments.

5. Control Type
 - a. Modulating:
 - (1) Proportional Control: 4-20mA or 0-10Vdc input signal to modulate the actuator proportionally throughout its angle of rotation.
 - b. Two-Position Control: Digital input signal to modulate the actuator to its open or closed position.
- O. Stroke Time:
1. Ultra-High Speed Actuators
 - a. Used where indicated on drawings.
 - b. Operate the damper from fully closed to fully open and vice versa within 10 seconds.
 2. High Speed Actuators
 - a. Typical for:
 - (1) Fan changeover isolation dampers
 - (2) Duct pressure control dampers
 - (3) Duct flow control dampers
 - (4) Where indicated on drawings
 - b. Operate the damper from fully closed to fully open and vice versa within 45 seconds.
 - c. For spring return actuators move damper to failed position within 25 seconds.
 3. Normal Speed Actuators
 - a. Typical for all applications not indicated for high speed or ultra-high speed.
 - b. Operate the damper from fully closed to fully open and vice versa within 95 seconds.
 - c. For spring return actuators move damper to failed position within 25 seconds.

PART 3 - EXECUTION

3.1 APPLICATION

- A. Damper
1. Utilize parallel blade at:
 - a. Air handling unit minimum outdoor air damper.
 - b. Air handling unit return air damper.
 - c. Where indicated on drawings.
 2. Utilize opposed blade at:
 - a. Air handling unit relief air.
 - b. Air handling unit maximum outdoor air damper.
 - c. Exhaust fan isolation.
 - d. Where indicated on drawings.
- B. Actuators
1. Utilize spring return actuators for all control dampers except those indicated to be non-spring return or electronic fail safe actuators.
 2. Utilize non-spring return actuators where indicated on drawings.

3. Utilize electronic fail safe actuators at:
 - a. Dampers requiring ultra-high speed actuator speed.
 - b. Where indicated on drawings.
- C. Actuator Speed
 1. Ultra-High Speed
 - a. Used where indicated on drawings.
 2. High Speed
 - a. Typical for:
 - (1) Fan changeover isolation dampers
 - (2) Duct pressure control dampers
 - (3) Duct flow control dampers
 - (4) Where indicated on drawings
 3. Normal Speed
 - a. Typical for all applications not indicated for high speed or ultra-high speed.

3.2 INSTALLATION

- A. Damper submittals shall be coordinated for type, quantity, and size to ensure compatibility with sheet metal design.
- B. Duct openings shall be free of any obstruction or irregularities that might interfere with blade or linkage rotation or actuator mounting. Duct openings shall measure $\frac{1}{4}$ in. larger than damper dimensions and shall be square, straight, and level.
- C. Individual damper sections, as well as entire multiple section assemblies, must be completely square and free from racking, twisting, or bending. Measure diagonally from upper corners to opposite lower corners of each damper section. Both dimensions must be within 0.3 cm (1/8 in.) of each other.
- D. Follow the manufacturer's instructions for field installation of control dampers. Unless specifically designed for vertical blade application, dampers must be mounted with blade axis horizontal.
- E. Damper actuators shall be direct coupled to the damper control shaft wherever possible. Where required, install extended shaft or jackshaft according to manufacturer's instructions.
- F. Damper blades, axles, and linkage must operate without binding. Before system operation, cycle damper after installation to ensure proper operation. On multiple section assemblies, all sections must open and close simultaneously.
- G. Provide a visible and accessible indication of damper position on the drive shaft end.
- H. Support ductwork in area of damper when required to prevent sagging due to damper weight.
- I. After installation of low-leakage dampers with seals, caulk between frame and duct or opening to prevent leakage around perimeter of damper.
- J. Install smooth transitions, not exceeding 20°, to dampers smaller than adjacent duct. Install transitions as close to damper as possible but at distance to avoid interference and impact to performance. Consult manufacturer for recommended clearance.

- K. Clearance:
 - 1. Locate dampers for easy access and provide separate support of dampers that cannot be handled by service personnel without hoisting mechanism.
 - 2. Install dampers with at least 24 inches (600 mm) of clear space on sides of dampers requiring service access.
- L. Service Access:
 - 1. Dampers and actuators shall be accessible for visual inspection and service.
 - 2. Install access door(s) in duct or equipment located upstream of damper to allow service personnel to hand clean any portion of damper, linkage, and actuator. Comply with requirements in Section 233300 "Air Duct Accessories."
- M. Install dampers straight and true, level in all planes, and square in all dimensions. Install supplementary structural steel reinforcement for large multiple-section dampers if factory support alone cannot handle loading.
- N. Attach actuator(s) to damper drive shaft.
- O. For duct-mounted and equipment-mounted dampers installed outside of equipment, install a visible and accessible indication of damper position from outside.

3.3 ELECTRIC POWER

- A. Furnish and install electrical power to products requiring electrical connections.
- B. Furnish and install circuit breakers. Comply with requirements in Section 262816 "Enclosed Switches and Circuit Breakers."
- C. Furnish and install power wiring. Comply with requirements in Section 260519 "Low-Voltage Electrical Power Conductors and Cables."
- D. Furnish and install raceways. Comply with requirements in Section 260533 "Raceways and Boxes for Electrical Systems."
- E. Connect electrical devices and components to electrical grounding system. Comply with requirements in Section 260526 "Grounding and Bonding for Electrical Systems."

3.4 CHECKOUT PROCEDURES

- A. Control-Damper Checkout:
 - 1. Check installed products before continuity tests, leak tests, and calibration.
 - 2. Check dampers for proper location and accessibility.
 - 3. Verify that control dampers are installed correctly for flow direction.
 - 4. Verify that proper blade alignment, either parallel or opposed, has been provided.
 - 5. Verify that damper frame attachment is properly secured and sealed.
 - 6. Verify that damper actuator and linkage attachment are secure.
 - 7. Verify that actuator wiring is complete, enclosed, and connected to correct power source.
 - 8. Verify that damper blade travel is unobstructed.

3.5 TESTING

A. Acceptance Test

1. Stroke and adjust control dampers following manufacturer's recommended procedure, from 100% open to 100% closed back to 100% open.
2. Stroke control dampers with pilot positioners. Adjust damper and positioner following manufacturer's recommended procedure, so damper is 100% closed, 50% closed, and 100% open at proper air pressure.
3. Check and document open and close cycle times for all control dampers.
4. For control dampers equipped with positive position indication, check feedback signal at multiple positions to confirm proper position indication.
5. Provide test result report within two weeks of testing indicating completion of the Acceptance Test for each control damper.

END OF SECTION

P:\22 Projects\22-1142-00coev\04 Design\07 Specs\Div 23\23 0912-Control Dampers.docx

**SECTION 23 0927
TEMPERATURE INSTRUMENTS**

PART 1 - GENERAL

1.1 SCOPE OF WORK

- A. Air temperature sensor/transmitters
- B. Liquid temperature sensor/transmitters

1.2 DEFINITIONS

- A. NIST: National Institute of Standards and Technology
- B. RTD: Resistance temperature detector.

1.3 CODES AND STANDARDS (UTILIZE LATEST EDITION)

- A. National Fire Protection Association (NFPA)
 - 1. NFPA 90A: Installation of Air Conditioning and Ventilating Systems
- B. National Electrical Manufacturers Association (NEMA)
 - 1. NEMA 250: Enclosures for Electrical Equipment (1,000 volts maximum)
- C. Sheet Metal and Air Conditioning Contractors' National Association (SMACNA)
 - 1. SMACNA: HVAC Duct Construction Standards-Metal and Flexible

1.4 QUALITY ASSURANCE

- A. This Section establishes a minimum quality of hardware and installation and establishes standard equipment or equipment configurations.
- B. Work installed by the Contractor shall be done in a neat and workmanlike manner, as determined by Owner and in keeping with acceptable standards for this type of work.
- C. Unless indicated in this specification, all materials used shall be new. Where items have been indicated to be reused, it is the Contractor's responsibility to insure that the reused items are operating properly and are in good condition. Contractor must make Owner aware of defective items designated for reuse. Owner will be responsible for repairs.
- D. Device ratings and enclosures shall be as required by ambient conditions where product is to be installed.

1.5 SUBMITTALS

- A. Preconstruction – Prior to construction provide the following in accordance with Specification 20 0500 – Basic Requirements for Mechanical, Plumbing, and Fire Suppression:
 - 1. Product Data: For each type of product, including the following:
 - a. Construction details, material descriptions, dimensions of individual components and profiles, and finishes.
 - b. Operating characteristics; electrical characteristics; and furnished accessories indicating process operating range, accuracy over range, control signal over range, default control signal with loss of power, calibration data specific to each unique application, electrical

- power requirements, and limitations of ambient operating environment, including temperature and humidity.
 - c. Product description with complete technical data, performance curves, and product specification sheets.
 - d. Installation instructions, including factors affecting performance.
 - 2. Manufacturer's installation and operating manuals.
- B. Contract Closeout – At contract closeout provide the following in accordance with Specification 20 0500 – Basic Requirements for Mechanical, Plumbing, and Fire Suppression:
 - 1. Operating and Maintenance Data including:
 - a. Product data
 - b. Installation instructions
 - c. Assembly drawings
 - d. Replacement parts list
 - e. Maintenance and operation instructions
 - 2. NIST Calibration Certificates
 - 3. Test Reports
 - a. Manufacturer Installation Inspection Report
 - 4. Warranties

1.6 DELIVERY, STORAGE AND HANDLING

- A. Deliver products to site under provisions of Division 1.
- B. Deliver products to site in containers with manufacturer's stamp affixed.
- C. Protect products against dirt, water, chemical and mechanical damage before, during and after installation. Damage to products prior to final acceptance of the Work shall be repaired or replaced at no additional cost to the Owner.

1.7 SPARE PARTS

Not Applicable

1.8 WARRANTY

- A. One year warranty on products and complete installation commencing at the time of Substantial Completion

1.9 MAINTENANCE

Not Applicable

PART 2 - PRODUCTS

2.1 AIR TEMPERATURE

- A. Temperature sensing shall be RTDs with matched transmitters. Thermistors, nickel and silver elements, thermocouples or pneumatic transmitters shall not be allowed.

- B. Match sensor with temperature transmitter and factory calibrate together. Each matched sensor and transmitter set shall include factory calibration data traceable to NIST.
- C. Obtain temperature-measuring sensors and transmitters single manufacturer.
- D. The transmitter shall be compatible with the temperature element and the DDC panel. The assembly shall be factory calibrated over the entire operating span.
- E. Duct Averaging temperature sensor/transmitter
 - 1. Acceptable Manufacturers
 - a. Minco
 - b. Automation Components
 - c. Johnson Controls (Flexible only)
 - d. Siemens
 - e. Building Automation Products
 - 2. Rigid Averaging
 - a. Averaging sensor for installation in duct with multiple RTD sensors in a rigid sheath to provide average temperature across the entire length of the sensor.
 - b. Construction:
 - (1) Sensor: Multiple 1000Ω platinum RTD in a brass sheath.
 - (2) Length: As required to cover the widest dimension of the duct.
 - (3) Enclosure: Galvanized steel junction box with removable cover and gasket for attachment to duct to seal penetration airtight. NEMA 250, Type 1 for indoor applications. NEMA 250, Type 4 for outdoor applications.
 - (4) Temperature Coefficient of Resistance: 0.00375 Ω/Ω/°C or 0.00385 Ω/Ω/°C
 - c. Performance:
 - (1) Temperature Range: 20F-120°F
 - (2) RTD Resistance Accuracy: ±0.25% at 32°F
 - (3) Drift: ±0.14°C
 - d. Transmitter:
 - (1) Output: 4 to 20 mA over the specified range, linear with temperature.
 - (2) Adjustments: Zero and span, ±5% of span.
 - (3) Ambient Temperature: 32F-122°F
 - (4) Range: 40-120°F
 - (5) NIST traceable match calibrated to 0.75% total system accuracy through the range of operation.
 - (6) Calibration Accuracy: ±0.2% of span.
 - (7) Linearity: ±0.1% of span
 - e. Basis of Design: Minco S493PF.
 - 3. Flexible Averaging
 - a. Averaging sensor for installation in duct or equipment with multiple RTD sensors in a flexible sheath to provide average temperature across the entire length of the sensor.

- b. Construction:
 - (1) Sensor: Multiple 1000Ω platinum RTD in a copper or aluminum sheath.
 - (2) Length: As required to cover the entire cross section of the air tunnel.
 - (3) Enclosure: Galvanized steel junction box with removable cover and gasket for attachment to duct to seal penetration airtight. NEMA 250, Type 1 for indoor applications. NEMA 250, Type 4 for outdoor applications.
 - (4) Temperature Coefficient of Resistance: 0.00375 Ω/Ω/°C or 0.00385 Ω/Ω/°C
 - c. Performance:
 - (1) Temperature Range: 20F-120°F.
 - (2) RTD Resistance Accuracy: ±0.25% at 32°F
 - (3) Drift: ±0.14°C
 - d. Transmitter:
 - (1) Output: 4 to 20 mA over the specified range, linear with temperature.
 - (2) Adjustments: Zero and span, ±5% of span.
 - (3) Ambient Temperature: 32°F-122°F
 - (4) Range: 40-120°F
 - (5) NIST traceable match calibrated to 0.75% total system accuracy through the range of operation.
 - (6) Calibration Accuracy: ±0.2% of span.
 - (7) Linearity: ±0.1% of span
 - e. Basis of Design: Minco S475PF.
- F. Single point temperature sensor/transmitter
- 1. Acceptable Manufacturers
 - a. Minco
 - b. Automation Components
 - c. Johnson Controls
 - d. Siemens
 - e. Building Automation Products
 - 2. Single point sensor for installation in duct or equipment with one sensor in a rigid sheath to provide temperature reading at the midpoint of the air tunnel.
 - 3. Construction:
 - a. Sensor: Single 1000Ω platinum RTD in a stainless steel sheath.
 - b. Length: As required to position the sensor tip at the midpoint of the air tunnel.
 - c. Enclosure: Galvanized steel junction box with removable cover and gasket for attachment to duct to seal penetration airtight. NEMA 250, Type 1 for indoor applications. NEMA 250, Type 4 for outdoor applications.
 - d. Temperature Coefficient of Resistance: 0.00375 Ω/Ω/°C or 0.00385 Ω/Ω/°C
 - 4. Performance
 - a. Temperature Range: 20F -120°F
 - b. RTD Resistance Accuracy: ±0.25% at 32°F

- c. Drift: $\pm 0.14^{\circ}\text{C}$
- 5. Transmitter:
 - a. Output: 4 to 20 mA over the specified range, linear with temperature.
 - b. Adjustments: Zero and span, $\pm 5\%$ of span.
 - c. Ambient Temperature: 32F-122°F for indoor transmitters
 - d. Range:
 - (1) Duct: 40°F -120°F
 - (2) Outdoor air: -30F–120°F
 - (3) Space: 50°F-90°F
 - e. NIST traceable match calibrated to 0.75% total system accuracy through the range of operation.
 - f. Calibration Accuracy: $\pm 0.2\%$ of span.
 - g. Linearity: $\pm 0.1\%$ of span
- 6. Space temperature sensor
 - a. Provide sensor/transmitter as specified above.
 - b. The assembly shall consist of a decorative ventilated enclosure acceptable to Owner.
 - c. In addition, provide the following for space sensors used with Terminal Equipment ASC Controllers:
 - (1) Digital temperature display
 - (2) Set point adjustment
- 7. Basis of design: Duct - Minco S451PF, Outdoor air – Minco S455PF with sun shield.

2.2 LIQUID TEMPERATURE

- A. Temperature sensing shall be RTDs with matched transmitters. Thermistors, nickel and silver elements, thermocouples or pneumatic transmitters shall not be allowed.
- B. Match sensor with temperature transmitter and factory calibrate together. Each matched sensor and transmitter set shall include factory calibration data traceable to NIST.
- C. Obtain temperature-measuring sensors and transmitters single manufacturer.
- D. The transmitter shall be compatible with the temperature element and the DDC panel. The assembly shall be factory calibrated over the entire operating span.
- E. Immersion Temperature Sensor
 - 1. Acceptable Manufacturers
 - a. Minco
 - b. Automation Components
 - c. Johnson Controls
 - d. Siemens
 - e. Building Automation Products
 - 2. Single point sensor for installation in pipe with one sensor in a thermowell to provide temperature reading at the midpoint of the pipe.

3. Construction:
 - a. Sensor: Single 1000Ω platinum RTD in a stainless steel thermowell.
 - b. Length: As required to position the sensor tip at the midpoint of the air tunnel.
 - c. Enclosure: NEMA 250, Type 3R galvanized steel connection head with removable cover. NEMA 250, Type 4 for outdoor applications.
 - d. Temperature Coefficient of Resistance: 0.00375 Ω/Ω/°C or 0.00385 Ω/Ω/°C
4. Performance
 - a. Temperature Range: -40°F-212°F.
 - b. RTD Resistance Accuracy: ±0.25% at 32°F
 - c. Drift: ±0.14°C
5. Transmitter:
 - a. Location: Sensor mounted
 - b. Output: 4 to 20 mA over the specified range, linear with temperature.
 - c. Adjustments: Zero and span, ±5% of span.
 - d. Ambient Temperature: 32°F-122°F
 - e. Range:
 - (1) Chilled Water: 40°F-70°F
 - (2) Condenser Water: 50°F-100°F
 - (3) Heating Water: 70°F-250°F
 - (4) Chilled Glycol: 25°F-70°F
 - (5) Dual Temperature Water: 25°F-250°F
 - f. NIST traceable match calibrated to 0.75% total system accuracy through the range of operation for heating water.
 - g. NIST traceable match calibrated to 0.2% total system accuracy through the range of operation for chilled, condenser and dual temperature water.
 - h. Calibration Accuracy: ±0.2% of span.
 - i. Linearity: ±0.1% of span
6. Basis of Design: Minco S480P/S490PW

PART 3 - EXECUTION

3.1 EXAMINATION

- A. Examine the complete set of plans, the process fluids, pressures, and temperatures and furnish instruments that are compatible with installed process condition.
- B. Examine substrates and conditions for compliance with requirements for installation tolerances and other conditions affecting performance.
- C. Examine roughing-in for instruments installed in piping to verify actual locations and connections before installation.
- D. Examine roughing-in for instruments installed in duct systems to verify actual locations and connections before installation.

- E. Prepare a written report listing conditions detrimental to performance. Proceed with installation only after unsatisfactory conditions have been corrected.

3.2 INSTALLATION

- A. Install products level, plumbing, parallel, and perpendicular with building construction.
- B. Properly support instruments, tubing, piping, wiring, and conduit to comply with requirements indicated. Brace all products to prevent lateral movement and sway or a break in attachment.
- C. Fastening Hardware:
 - 1. Wrenches, pliers, and other tools that cause injury to or mar surfaces of rods, nuts, and other parts are prohibited for work of assembling and tightening nuts.
 - 2. Tighten bolts and nuts firmly and uniformly. Do not overstress threads by excessive force or by oversized wrenches.
 - 3. Lubricate threads of bolts, nuts, and screws with graphite and oil before assembly.
- D. Install products in locations that are accessible and that permit calibration and maintenance from floor, equipment platforms, or catwalks.
- E. Space sensors on exterior walls shall be mounted on an insulated backplate and the hole into the wall completely sealed. If conduit is used up to the device, the conduit shall be plugged with insulation to prevent cold air from entering the device.
- F. Coordinate exact mounting height and location of space sensors with architectural plans and elevations. Mounting height shall comply with codes and accessibility requirements. Space sensors shall be mounted 4'0" above the finished floor line or in line with existing devices unless otherwise noted.
- G. Protect products installed outdoors from solar radiation, building and wind effect with stand-offs and shields
- H. Liquid Temperature Sensor Installation:
 - 1. Assembly shall include sensor, thermowell and connection head.
 - 2. For pipe 4" and larger, install sensor and thermowell length to extend into pipe between 50 to 75% of pipe cross section.
 - 3. For pipe smaller than 4":
 - a. Install reducers to increase pipe size to 4" at point of thermowell installation.
 - b. For pipe sizes 2½" and 3", thermowell and sensor may be installed at pipe elbow or tee to achieve manufacturer-recommended immersion depth in lieu of increasing pipe size.
 - c. Minimum insertion depth shall be 2½".
 - 4. Install matching thermowell.
 - 5. Fill thermowell with heat-transfer fluid before inserting sensor.
 - 6. For insulated piping, install thermowells with extension neck to extend beyond face of insulation.
 - 7. Install thermowell in top dead center of horizontal pipe positioned in an accessible location to allow for inspection and replacement.

- I. Averaging Duct Temperature Sensor Installation:
 - 1. Install averaging-type air temperature sensor for temperature sensors located within air-handling units, and large ducts with air tunnel cross-sectional area of 20 ft² and larger or where indicated on the Drawings.
 - 2. Install sensor length to maintain coverage over entire cross-sectional area. Install multiple sensors where required to maintain the minimum coverage.
 - 3. Fasten and support sensor with manufacturer-furnished clips to keep sensor taut throughout entire length.
- J. Corrosive Environments:
 - 1. Use products that are suitable for environment to which they are subjected.
 - 2. When conduit is in contact with a corrosive environment, use Type 316 stainless-steel conduit and fittings or conduit and fittings that are coated with a corrosive-resistant coating that is suitable for environment.
 - 3. Where instruments are located in a corrosive environment and are not corrosive resistant from manufacturer, field install products in a NEMA 250, Type 4X enclosure constructed of Type 316L stainless steel.
- K. Seal penetrations to ductwork, plenums, and air-moving equipment to comply with duct static pressure class and leakage and seal classes indicated using neoprene gaskets or grommets.
- L. Where instruments are installed on insulated ductwork, install such that the insulation and vapor barrier are not cut or interrupted.

3.3 IDENTIFICATION

- A. Identify system components, wiring, cabling, and terminals. Each piece of wire, cable, and tubing shall have the same designation at each end for operators to determine continuity at points of connection. Comply with requirements for identification specified in Section 20 0553 "Identification for Mechanical, Plumbing, and Fire Suppression Systems."
- B. Install engraved phenolic nameplate identification at instrument.

3.4 ELECTRIC POWER

- A. Furnish and install electrical power to products requiring electrical connections.
- B. Furnish and install raceways. Comply with requirements in Division 26 specifications.
- C. Connect electrical devices and components to electrical grounding system. Comply with requirements in Division 26 specifications.

3.5 CLEANING

- A. Remove grease, mastic, adhesives, dust, dirt, stains, fingerprints, labels, and other foreign materials from exposed interior and exterior surfaces.
- B. Wash and shine glazing.
- C. Polish glossy surfaces to a clean shine.

3.6 CHECK-OUT PROCEDURES

- A. Inspection
 - 1. Check installed products before continuity tests, leak tests, and calibration.
 - 2. Check instruments for proper location and accessibility.
 - 3. Check flow instruments for proper installation for direction of flow, elevation, orientation, insertion depth, or other applicable considerations that will impact performance.
 - 4. Check instrument tubing for proper isolation, fittings, slope, dirt legs, drains, material, and support.
 - 5. Check that instrument attachment is properly secured and sealed.
- B. Validation
 - 1. Verify that instrument wiring is complete, enclosed, and connected to correct power source.
 - 2. Verify sensing element type and proper material.
 - 3. Verify instrument tag against approved submittal.

3.7 CALIBRATION

- A. General
 - 1. Calibrate each instrument installed that is not factory calibrated and provided with calibration documentation.
 - 2. Provide a written description of proposed field procedures and equipment for calibrating each type of instrument. Submit procedures before calibration and adjustment.
 - 3. For each analog instrument, make a three-point test of calibration for both linearity and accuracy.
 - 4. Equipment and procedures used for calibration shall meet instrument manufacturer's written instructions.
 - 5. Provide diagnostic and test equipment for calibration and adjustment.
 - 6. Field instruments and equipment used to test and calibrate installed instruments shall have accuracy at least twice the instrument accuracy being calibrated.
 - 7. Calibrate each instrument according to instrument instruction manual supplied by manufacturer.
 - 8. If after calibration indicated performance cannot be achieved, replace out-of-tolerance instruments.
 - 9. Comply with field-testing requirements and procedures indicated by ASHRAE Guideline 11, "Field Testing of HVAC Control Components," in the absence of specific requirements and to supplement requirements indicated.
- B. Calibration of analog signals
 - 1. Check analog voltage signals using a precision voltage meter at zero, 50%, and 100%.
 - 2. Check analog current signals using a precision current meter at zero, 50%, and 100%.

- C. Calibration of digital signals
 - 1. Check digital signals using a jumper wire.
 - 2. Check digital signals using an ohmmeter to test for contact.
- D. Calibration of sensors: Check sensors at zero, 50%, and 100% of the design values.
- E. Calibration of switches: Calibrate switches to make or break contact at set points indicated.
- F. Calibration of transmitters:
 - 1. Check and calibrate transmitters at zero, 50%, and 100% of Project design values.
 - 2. Calibrate resistance temperature transmitters at zero, 50%, and 100% of span using a precision-resistance source.

3.8 TESTING

- A. Manufacturer Installation Inspection Report - Provide report prepared by manufacturer's representative, stating that systems installed and services provided under this Section are in accordance with manufacturer's recommendations and are properly operating.

END OF SECTION

P:\22 Projects\22-1142-00coev\04 Design\07 Specs\Div 23\23 0927-Temperature Instruments.docx

**SECTION 23 1113
FUEL GAS PIPING**

PART 1 - GENERAL

1.1 WORK INCLUDED

- A. Pipe and pipe fittings
- B. Valves and gas cocks
- C. Natural gas piping system

1.2 CODES AND STANDARDS (USE LATEST EDITIONS)

- A. American National Standards Institute (ANSI)
 - 1. ANSI A21.52: Ductile-Iron Pipe, Centrifugally Cast, in Metal Molds or Sand-Lined Molds for Gas
 - 2. ANSI Z21.69: Connectors for Movable Gas Appliances
- B. American Society of Mechanical Engineers (ASME)
 - 1. ASME B16.3: Malleable Iron Threaded Fittings Class 150 NS 300
 - 2. ASME B16.23: Cast Copper Alloy Solder Joint Drainage Fittings DWV
 - 3. ASME B16.29: Wrought Copper and Wrought Copper Alloy Solder Joint Drainage Fittings DWV
 - 4. ASME Sec. 9: Welding and Brazing Qualifications
 - 5. ASME: Boiler and Pressure Vessel Code
- C. American Society for Testing and Materials (ASTM)
 - 1. ASTM A234: Pipe Fittings of Wrought Carbon Steel and Alloy Steel for Moderate and Elevated Temperatures
 - 2. ASTM A377-79: Gray Iron and Ductile Iron Pressure Pipe
 - 3. ASTM A53: Pipe, Steel, Black and Hot Dipped Zinc Coated, Welded and Seamless
 - 4. ASTM B32: Solder Metal
 - 5. ASTM B88: Seamless Copper Water Tube
 - 6. ASTM D1785: Poly (Vinyl Chloride) (PVC) Plastic Pipe, Schedules 40, 80 and 120
 - 7. ASTM D2241: Poly (Vinyl Chloride) (PVC) Plastic Pipe (SDR PR)
 - 8. ASTM D2466: Poly (Vinyl Chloride) (PVC) Plastic Piping Fittings. Schedule 40.
 - 9. ASTM D2513: Thermoplastic Gas Pressure Pipe, Tubing and Fittings
 - 10. ASTM D2517: Reinforced Epoxy Resin Gas Pressure Pipe and Fittings
 - 11. ASTM D2683: Socket Type Polyethylene Fittings for Outside Diameter Controlled Polyethylene Pipe
 - 12. ASTM D2855: Making Solvent Cemented Joints with Poly (Vinyl Chloride) (PVC) Pipe and Fittings
- D. American Welding Society (AWS)
 - 1. AWS A5.8: Brazing Filler Metal

- 2. AWS D1.1: Structural Welding Code
- E. American Water Works Association (AWWA)
 - 1. AWWA C105: Polyethylene Encasement for Ductile Iron Piping for Water and Other Liquids
 - 2. AWWA C110: Ductile Iron and Gray Iron Fittings 3 in. through 48 in., for Water and Other Liquids
 - 3. AWWA C111: Rubber Gasket Joints for Ductile Iron and Gray Iron Pressure Pipe and Fittings
 - 4. AWWA C151: Ductile Iron Pipe, Centrifugally Cast in Metal Molds or Sand Lined Molds, for Water or Other Liquids
- F. American Gas Association Laboratories (AGA)
- G. Environmental Protection Agency (EPA)
- H. Underwriters Laboratories Inc. (UL)

1.3 QUALITY ASSURANCE

- A. Pipe: Each length of pipe shall be legibly identified at mill by paint, stenciling or raised symbols identifying manufacturer and class type or schedule of pipe. Copper pipe shall be identified at 3 foot intervals.
- B. Fittings: To be identified by the manufacturer by permanently attached tags, imprints or other approved means, indicating the class of wall thickness and material.
- C. Valves and Gas Cocks: All valves shall be listed and labeled for natural gas service by UL, CSA or a Nationally Recognized Testing Laboratory acceptable to the authority having jurisdiction and the local gas utility company. Manufacturer's name and pressure rating shall be marked on valve body.
- D. Welding Materials and Procedures: Conform to ASME Code and applicable state labor regulations.
- E. Welders Certification: In accordance with ASME Sec 9.

1.4 SUBMITTALS

- A. Preconstruction – Prior to construction provide the following in accordance with Specification 20 0500 – Basic Requirements for Mechanical, Plumbing, and Fire Suppression:
 - 1. Product Data: Submit product data for each type of the products listed in Part 2 including:
 - a. Product description
 - b. Model
 - c. Dimensions
 - d. Rough in requirements
 - e. Service sizes
 - f. Finishes
 - 2. Shop Drawings: For all new piping systems submit layout drawings at ¼" – 1'-0" scale in both hard-copy and AutoCAD compatible format. Shop drawings shall include, but not be limited to:
 - a. Piping layout indicating sizes and locations
 - b. Elevations of piping
 - c. Slopes of horizontal piping
 - d. Wall and floor penetrations

- e. Pressure rating for each service
 - f. Penetrations through fire-rated and other partitions, floors, etc.
 - g. Equipment installation and connections based on the equipment being used on the Project
 - h. Hangers and supports including multiple pipe hangers
 - i. Location of alignment guides, expansion joints, and anchors, including attachment to building structure
 - j. Shop drawings shall show other building and building system components for coordination purposes. Input from other installers shall be obtained. Any proposed changes to piping layout required for coordination purposed shall be indicated. Coordination items shown shall include but no be limited to:
 - (1) Any pipe (e.g. sprinkler, plumbing pipes, roof drains, etc.) in vicinity of gas or fuel oil piping
 - (2) Electrical equipment, duct banks, and conduit
 - (3) Structural members, including structural members to which piping supports and anchors will be attached
3. Manufacturer's installation and operating manuals.
 4. Welding certificates.
- B. During Construction – During construction provide and maintain the following in accordance with Specification 20 0500 – Basic Requirements for Mechanical, Plumbing, and Fire Suppression:
1. Site Record Drawings - Maintain a set of drawings on site during construction showing the exact routing and location of piping systems being installed. The drawing shall be updated neatly by hand on a daily basis and account for routing modifications made in the field. Contractor shall use these drawing as a basis for generating the project as-built drawings.
- C. Contract Closeout – At contract closeout provide the following in accordance with Specification 20 0500 – Basic Requirements for Mechanical, Plumbing, and Fire Suppression:
1. Operation and Maintenance Data including:
 - a. Product data
 - b. Installation instructions
 - c. Assembly views
 - d. Replacement parts list
 - e. Maintenance and operation instructions
 2. As-Built Drawings
 - a. Upon completion of project, Contractor shall furnish as-built drawings showing in scale the exact routing and locations of all newly installed piping systems. Submit in both hard-copy and electronic AutoCAD format.
 3. Test Reports
 - a. Pipe Pressure Test
 4. Warranties

1.5 DELIVERY, STORAGE AND HANDLING

- A. Protect new pipe interiors from moisture, construction debris and dust, and other foreign materials with the use of plastic end caps/plugs on each end of pipe. Maintain end-caps/plugs in place until piping is installed. Open end of pipes should be capped/plugged throughout construction.
- B. Store materials indoors, protected from the weather. Where exterior storage is necessary, elevate piping above grade and enclose with waterproof wrapping or cover.
- C. Deliver and store valves in shipping containers with labeling in place.
- D. Replace any piping or devices which are damaged during shipping or storage.

1.6 SPARE PARTS

Not Applicable

1.7 WARRANTY

- A. One year warranty on products and complete installation commencing at the time of Substantial Completion

1.8 MAINTENANCE

Not Applicable

PART 2 - PRODUCTS

2.1 NATURAL GAS PIPING, ABOVE GRADE

- A. Steel Pipe: ASTM A53, Schedule 40 black. Fittings: ASME B16.3, malleable iron, or ASTM A234, forged steel welding type. Joints: Screwed for pipe 2" and under; AWS D1.1, welded, for pipe over 2".
- B. Flexible Gas Hose Connectors: UL listed stainless steel hose and braided cover with carbon steel fittings. Up to 2½" pipe size provide male threaded ends.

2.2 FLANGES, UNIONS AND COUPLINGS

- A. Pipe Size 2" and Under: ASME B16.3 150 psig malleable iron unions for threaded ferrous piping; ASME B16.15 bronze unions for copper pipe, soldered joints.
- B. Unions Above 150 psig: 300 psig malleable iron, brass to iron seat ground joint air tested unions.
- C. Pipe Size Over 2": ASME B16.5 150 psig forged steel slip on flanges for ferrous piping; ANSI/ASME B16.24 bronze flanges for copper piping; neoprene gaskets for gas service; 1/16" thick preformed neoprene.
- D. Flanges to match those on valves and equipment.
- E. Flange Bolts: ASTM A-193.
- F. Dielectric Connections:
 - 1. Flanged or union type: Gaskets to conform to manufacturer's recommendations for the intended service, rated at minimum temperature of 200°F (or higher as dictated by service) for continuous duty.
 - 2. Union type: Galvanized or plated steel-threaded end; copper -- solder end; water impervious isolation barrier.

3. Fittings provided shall meet ANSI B16.8 and be capable of isolating stray electrical currents up to 600 volts minimum.
4. Acceptable Manufacturers: B&K Industries, Inc., Eclipse, Inc., EPCO Sales Inc., Capital Manufacturing Company; Division of Harsco Corporation, Watts Regulator Company.

2.3 GATE VALVES

- A. Acceptable Manufacturers
 1. Crane
 2. Hammond
 3. Stockham
 4. Milwaukee
- B. Up to 2": 125 psi SWP, bronze body, union bonnet, bronze trim, rising stem with acme thread and square end, malleable iron, handwheel, inside screw, solid wedge or disc, threaded ends. Model 1152 manufactured by Milwaukee.
- C. 2" and greater: 125 psi SWP, iron body, bolted flanged yoke-bonnet, gland packed, bronze trim, rising stem, cast iron, handwheel, OS&Y, solid wedge, flanged ends. Model F-2885-M manufactured by Milwaukee.

2.4 SQUARE HEAD GAS COCKS (UP TO 2")

- A. Acceptable Manufacturers
 1. McDonald
 2. Walworth
- B. 125 psi bronze body, square head with check, bronze plug, non-lubricated, threaded ends, with one wrench operator for every ten plug cocks. Fig. 10604 manufactured by McDonald.

2.5 PLUG GAS COCKS (OVER 2")

- A. Acceptable Manufacturers
 1. Walworth
 2. Rockwell - Nordstrom
 3. DeZurik
- B. 175 psi, cast iron body, stop collar and plug, pressure lubricated, teflon packing, threaded ends, with wrench operator with set screw. Fig. 1796 manufactured by Walworth.

PART 3 - EXECUTION

3.1 INSTALLATION

- A. Ream pipe and tube ends. Remove burrs. Bevel plain end ferrous pipe.
- B. Remove scale and dirt, on inside and outside, before assembly.
- C. Prepare piping connections to equipment with flanges or unions.
- D. Field test all piping before start-up of equipment.

- E. Provide non conducting dielectric connections wherever jointing dissimilar metals.
- F. Route piping in orderly manner, plumb and parallel to building and maintain gradient.
- G. Install piping to conserve building space and not interfere with use of space and other work.
- H. Group piping whenever practical at common elevations. Space piping to permit paint and servicing of valves and cocks.
- I. Install piping to allow for expansion and contraction without stressing pipe, joints, or connected equipment. Refer to Division 20 Section 20 0516, "Expansion Compensation for Mechanical, Plumbing, and Fire Protection."
- J. Provide clearance for access to valves and fittings.
- K. Provide sleeves when penetrating floors and walls. Refer to Division 20 Section 20 0517, "Penetrations for Mechanical, Plumbing, and Fire Suppression Systems."
- L. Seal pipe and sleeve penetration to achieve fire resistance equivalent to fire separation required. Refer to Division 20 Section 20 0517, "Penetrations for Mechanical, Plumbing, and Fire Suppression Systems."
- M. Where pipe support members are welded to structural building framing, scrape, brush clean and apply one coat of zinc rich primer to welding.
- N. Install valves or cocks with stems upright or horizontal, not inverted.
- O. Install all gas piping in compliance with all local codes.
- P. Provide one wrench for every ten square head cocks and plug cocks sized 2" and smaller, minimum of one. Provide each plug cock sized 2½" and larger with a wrench with set screw.

3.2 APPLICATION

- A. Install unions downstream of valves and cocks.
- B. Install minimum shutoff cock 6" long dirt leg and union at gas fired equipment or apparatus connection.
- C. Install gate valves or cocks for shutoff and to isolate equipment, part of systems, or vertical risers.

3.3 WELDING

- A. All welding shall be performed by experienced welders in a neat and workmanlike manner. Welding done on piping, pressure vessels and structural steel under this section shall be performed only by persons who are currently qualified in accordance with ANSI Standard Code for Pressure Piping, Section I, Power Piping, Bulletin ANSI B31.1.0-1980; applicable portions of ASME Boiler and Pressure Vessel Code, Section I, Power Boilers, and Section IX, Welding Qualifications. Submit for approval and record certified copies of Procedure Specification for Welding, Welding Procedure Qualification Tests and Welder Performance Qualification Tests. Welding specifications and qualification tests shall be recorded on Forms Q-1, as recommended in Appendix II of Section IX of the ASME Boiler and Pressure Vessel Code. Records shall be certified by Contractor and shall be accessible to authorized inspector.
- B. Bevel piping on both ends before welding as required and defined in Code.

C. Use following weld spacing on all butt-welds:

<u>Nominal Pipe Wall Thick</u>	<u>Space</u>
¼" or less	⅛"
Over ¼" or less than ¾"	3/16"
¾" and over	3/16"

- D. Use backing rings on welds in all piping 3" and larger.
- E. Before start of any welding, remove all corrosion and other foreign material from surface to be welded.
- F. Welding shall be performed by either manual shielded metallic arc process or automatic submerged arc process. Use direct current exclusively.
- G. Electrodes to be used with manual shielded metallic arc method shall conform to ASTM A-233, Classification E-6010.
- H. Size of electrodes, voltages, current, thickness and number of passes or beads shall be in accordance with provisions of previous paragraph.
- I. After deposition, clean each layer of weld metal to remove all slab and scale by wire brushing or grinding, then chip where necessary to prepare for proper deposition of next layer.
- J. Weld reinforcement shall be not less than 1/16" nor more than ⅛" above normal surface of joined sections. Reinforcement shall be crowned at center and shall taper on each side to surface being joined. Exposed surface of weld shall present workmanlike appearance and shall be free of depressions below surface of joined members.
- K. No welding of any kind shall be done when temperature of base metal is lower than 0°F. Material to be welded during freezing temperatures shall be made warm and dry before welding is started. Temperature of metal shall be "warm to hand" – or approximately 60°F.
- L. All welders engaged in work performed under this Section shall have been qualified in accordance with test requirements of Section IX of the ASME Boiler and Pressure Vessel Code. Each operator shall identify his production welds by marking his regularly assigned identification number or mark within 1" of weld. Contractor shall submit to Engineer complete list of individual numbers of identifying marks and operator's name. Copy of each operator's certificate shall be filed with Engineer.
- M. Welds will be inspected visually by representatives of Engineer and Contractor. Any weld judged defective by Engineer from visual inspection shall be cut out and tested in presence of or his representative. In event any welder consistently produces high percentage of unsatisfactory production welds, he shall be discharged at request of Owner even though he is able to produce satisfactory welds when test expected in advance. Removal and replacement of test coupons and samplings shall be done at expense of Contractor.

3.4 TESTING

A. Pipe Pressure Test

- 1. Furnish all labor, material, instruments, supplies and services and bear all costs for the accomplishment of tests herein specified. Correct all defects appearing under test and repeat the tests until no defects are disclosed; leave the equipment clean and ready for use.

2. Field test all piping before start-up of systems. Tests of piping systems shall be conducted before connections to equipment are made and before piping is covered, buried or otherwise concealed.
3. Perform all tests other than herein specified which may be required by legal authorities or by agencies to whose requirements this work is to conform.
4. Furnish all necessary testing apparatus, make all temporary connections and perform all testing operations required, at no additional cost to Owner.
5. No work shall be painted, backfilled or concealed until authorized by Owner's representative and/or the Engineer representative.
6. Inform Engineer and Owner's representative 48 hours prior to when work is ready for test.
7. Systems found to have leaks shall be subjected to further tests when faulty joints have been repaired or replaced.
8. Welded joints shall be subjected to a hammer test while under pressure. For additional test requirements see welding specification.
9. Contractor shall be responsible for any corrective action required due to a failed pipe pressure test.
10. Perform the following tests on fuel piping:
 - a. Fuel gas piping shall be pneumatically tested with air or inert gas for minimum of 24 hours at 50 psig.
 - b. Test pressures shall be increased if necessary to comply with applicable codes.
11. Pipe Pressure Test Report - Submit documentation of pipe pressure testing and submit test result reports within two weeks of testing.

END OF SECTION

P:\22 Projects\P22-1142-00coev\04 Design\07 Specs\Div 23\23 1113-Fuel Gas Piping.docx

SECTION 23 2113
HYDRONIC PIPING AND SPECIALTIES

PART 1 - GENERAL

1.1 SCOPE OF WORK

- A. Hydronic pipe and fitting materials, joining methods, valves, and specialties in this section include:
 - 1. Heating water piping
 - 2. Domestic water make-up piping
 - 3. Equipment drain piping
 - 4. Valves
 - 5. Air control devices
- B. Services provided:
 - 1. Pipe pressure testing

1.2 DEFINITIONS

- A. CWP: Cold working pressure
- B. EPDM: Ethylene propylene copolymer rubber
- C. NBR: Acrylonitrile-butadiene, Buna-N, or nitrile rubber
- D. NRS: Non-rising stem
- E. OS&Y: Outside screw and yoke
- F. PTFE: Polytetrafluoroethylene
- G. RS: Rising stem
- H. SWP: Steam working pressure

1.3 CODES AND STANDARDS (USE LATEST EDITIONS)

- A. American Welding Society (AWS)
 - 1. AWS A5.8: Specification for Filler Metals for Brazing and Braze Welding
 - 2. AWS D1.1/D1.1M: Structural Welding Code - Steel
 - 3. AWS D10.12/D10.12M: Guide for Welding Mild Steel Pipe
- B. American Society of Mechanical Engineers (ASME)
 - 1. ASME B1.20.1: Pipe Threads, General Purpose, Inch
 - 2. ASME B16.1: Cast Iron Pipe Flanges and Flanged Fittings
 - 3. ASME B16.3: Malleable Iron Threaded Fittings
 - 4. ASME B16.4: Cast Iron Threaded Fittings
 - 5. ASME B16.5: Pipe Flanges and Flanged Fittings, NPS1/2 to NPS24
 - 6. ASME B16.10: Face-to-Face and End-to-End Dimensions of Valves

7. ASME B16.15: Cast Bronze Threaded Fittings.
8. ASME B16.18: Cast Copper Alloy Solder Joint Pressure Fittings.
9. ASME B16.21: Nonmetallic Flat Gaskets for Pipes Flanges
10. ASME B16.22: Wrought Copper and Copper Alloy Solder Joint Pressure Fittings
11. ASME B16.23: Cast Copper Alloy Solder Joint Drainage Fittings DWV.
12. ASME B16.24: Bronze Flanges and Flanged Fittings.
13. ASME B16.29: Wrought Copper and Wrought Copper Alloy Solder Joint Drainage Fittings DWV.
14. ASME B16.34: Valves – Flanged, Threaded and Welding End
15. ASME B16.39: Malleable Iron Threaded Pipe Unions
16. ASME B18.2.1: Square and Hex Bolts and Screws - Inch Series
17. ASME B31 Series: Code for Pressure Piping
18. ASME B31.1: Power Piping
19. ASME B31.9: Building Services Piping
20. ASME Boiler and Pressure Vessel Code: Section IV, "Heating Boilers"; Section VIII, "Pressure Vessels," Division 1; Section IX, "Welding and Brazing Qualifications"

C. American Society for Testing Materials (ASTM)

1. ASTM A 47/A 47M: Specification for Ferritic Malleable Iron Castings
2. ASTM A48/A 48M: Specification for Gray Iron Castings
3. ASTM A 53/A 53M: Specification for Pipe, Steel, Black and Hot-Dipped, Zinc-Coated, Welded and Seamless
4. ASTM A 106: Specification for Seamless Carbon Steel Pipe for High-Temperature Service
5. ASTM A 126: Specification for Gray Iron Castings for Valves, Flanges, and Pipe Fittings
6. ASTM A 234/A 234M: Specification for Piping Fittings of Wrought Carbon Steel and Alloy Steel for Moderate and High Temperature Services
7. ASTM A 307: Specification for Carbon Steel Bolts and Studs, 60 000 PSI Tensile Strength
8. ASTM A 395/A 395M: Specification for Ferritic Ductile Iron Pressure-Retaining Castings for Use at Elevated Temperatures
9. ASTM A 536: Specification for Ductile Iron Castings
10. ASTM A 733: Specification for Welded and Seamless Carbon Steel and Austenitic Stainless Steel Pipe Nipples
11. ASTM B 32: Specification for Solder Metal
12. ASTM B 61: Specification for Steam or Valve Bronze Castings
13. ASTM B 62: Specification for Composition Bronze of Ounce Metal Castings
14. ASTM B 75: Specification for Seamless Copper Tube
15. ASTM B 88: Specification for Seamless Copper Water Tube
16. ASTM B 306: Standard Specification for Copper Drainage Tube (DWV)

17. ASTM B 584: Specification for Copper Alloy Sand Castings for General Applications
 18. ASTM B 813: Specification for Liquid and Paste Fluxes for Soldering Applications of Copper and Copper Alloy Tube
 19. ASTM B 828: Practice for Making Capillary Joints by Soldering of Copper and Copper Alloy Tube and Fittings
 20. ASTM D 1785: Specification for PolyVinyl Chloride (PVC) Plastic Pipe, Schedules 40, 80, and 120
 21. ASTM D 2466: Specification for PolyVinyl Chloride (PVC) Plastic Pipe Fittings, Schedule 40
 22. ASTM D 2467: Specification for PolyVinyl Chloride (PVC) Plastic Pipe Fittings, Schedule 80
 23. ASTM D 2564: Specification for Solvent Cements for PolyVinyl Chloride (PVC) Plastic Piping Systems
 24. ASTM D 2672: Specification for Joints for IPS PVC Pipe Using Solvent Cement
 25. ASTM D 2846/D 2846M: Specification for Chlorinated Poly(Vinyl Chloride) (CPVC) Plastic Hot- and Cold-Water Distribution Systems
 26. ASTM D 2855: Practice for Making Solvent-Cemented Joints with Poly(Vinyl Chloride) (PVC) Pipe and Fittings
 27. ASTM F 402: Practice for Safe Handling of Solvent Cements, Primers, and Cleaners Used for Joining Thermostatic Pipe and Fittings
 28. ASTM F 438: Specification for Socket-Type Chlorinated PolyVinyl Chloride (CPVC) Plastic Pipe Fittings, Schedule 40
 29. ASTM F 439: Specification for Socket-Type Chlorinated PolyVinyl Chloride (CPVC) Plastic Pipe Fittings, Schedule 80
 30. ASTM F 441/F 441M: Specification for Chlorinated PolyVinyl Chloride (CPVC) Plastic Pipe, Schedules 40 and 80
 31. ASTM F 493: Specification for Solvent Cements for Chlorinated PolyVinyl Chloride (CPVC) Plastic Pipe and Fittings
 32. ASTM F 656: Specification for Primers for Use in Solvent Cement Joints of Poly (Vinyl Chloride) (PVC) Plastic Pipe and Fittings
 33. ASTM F 1545: Standard Specification for Plastic-Lined Ferrous Metal Pipe, Fittings, and Flanges
- D. American Water Works Association (AWWA)
1. AWWA C606: Grooved and Shouldered Joints
- E. Brazing Handbook.
- F. Copper Tube Handbook.
- G. Manufacturers Standardization Society (MSS)
1. MSS SP-45: Bypass and Drain Connections
 2. MSS SP-58: Pipe Hangers and Supports - Materials, Design and Manufacture
 3. MSS SP-67: Butterfly Valves
 4. MSS SP-68: High Pressure Butterfly Valves with Offset Design

5. MSS SP-70: Cast Iron Gate Valves, Flanged and Threaded Ends
6. MSS SP-71: Gray Iron Swing Check Valves, Flanged and Threaded Ends
7. MSS SP-72: Ball Valves with Flanged or Butt-Welding Ends for General Service
8. MSS SP-78: Cast Iron Plug Valves, Flanged and Threaded Ends
9. MSS SP-80: Bronze Gate, Globe, Angle and Check Valves
10. MSS SP-85: Gray Iron Globe and Angle Valves, Flanged and Threaded Ends
11. MSS SP-107: Transition Union Fittings for Joining Metal and Plastic Products
12. MSS SP-108: Resilient-Seated Cast Iron-Eccentric Plug Valves
13. MSS SP-110: Ball Valves, Threaded, Socket-Welding, Solder Joint, Grooved and Flared Ends
14. MSS SP-122: Plastic Industrial Ball Valves
15. MSS SP-125: Gray Iron and Ductile Iron In-Line, Spring-Loaded, Center-Guided Check Valves

1.4 QUALITY ASSURANCE

- A. Pipe: Each length of pipe shall be legibly identified at mill by paint, stenciling, or raised symbols identifying manufacturer and class type or schedule of pipe. Copper pipe shall be identified at 3 foot intervals.
- B. Fittings: To be identified by the manufacturer by permanently attached tags, imprints, or other approved means, indicating the class of wall thickness and material.
- C. Valves: Manufacturer's name and pressure rating marked on valve body.
- D. Comply with ASME B31.9, "Building Services Piping," for materials, products, and installation. Safety valves and pressure vessels shall bear the appropriate ASME label.
- E. Fabricate and stamp air separators and expansion tanks to comply with ASME Boiler and Pressure Vessel Code: Section VIII, Division 01.
- F. Welding Materials and Procedures: Conform to ANSI/ASME SEC 9 and applicable state labor regulations.
 1. Comply with provisions in ASME B31 Series, "Code for Pressure Piping."
 2. Certify that each welder has passed AWS qualification tests for welding processes involved and that certification is current.
- G. Steel Support Welding: Qualify processes and operators according to AWS D1.1/D1.1M, "Structural Welding Code - Steel."
- H. Qualifications for Fiberglass Pipe and Fitting Installers: Installers of RTRF and RTRP shall be certified by the manufacturer of pipes and fittings as having been trained and qualified to join fiberglass piping with manufacturer-recommended adhesive.
- I. All grooved piping products shall be supplied by a single manufacturer. Grooving tools shall be of the same manufacturer as the grooved components. Grooving procedures shall be in accordance with the manufacturer's current listed standards conforming to ANSI/AWWA C606.

1.5 SUBMITTALS

- A. Preconstruction – Prior to construction provide the following in accordance with Specification 20 0500 – Basic Requirements for Mechanical, Plumbing, and Fire Suppression:
1. Product Data: Submit product data for each type of the products listed in Part 2 including:
 - a. Product description
 - b. Model
 - c. Dimensions
 - d. Rough in requirements
 - e. Service sizes
 - f. Finishes
 2. Shop Drawings: For all new piping systems submit layout drawings at ¼" – 1'-0" scale in both hard-copy and AutoCAD compatible format. Shop drawings shall include, but not be limited to:
 - a. Piping layout indicating sizes and locations
 - b. Elevations of piping
 - c. Slopes of horizontal piping
 - d. Wall and floor penetrations
 - e. Pressure rating for each service
 - f. Penetrations through fire-rated and other partitions, floors, etc.
 - g. Equipment installation and connections based on the equipment being used on the Project
 - h. Hangers and supports including multiple pipe hangers
 - i. Location of alignment guides, expansion joints, and anchors, including attachment to building structure
 - j. Shop drawings shall show other building and building system components for coordination purposes. Input from other installers shall be obtained. Any proposed changes to piping layout required for coordination purposed shall be indicated. Coordination items shown shall include but no be limited to:
 - (1) Any pipe (e.g. sprinkler, plumbing pipes, roof drains, etc.) in vicinity of hydronic piping
 - (2) Electrical equipment, duct banks, and conduit
 - (3) Structural members, including structural members to which piping supports and anchors will be attached
 - (4) Ceiling access panels required for hydronic piping and accessories
 3. Manufacturer's installation and operating manuals.
 4. Welding certificates.
 5. Inspection certificates for pressure vessels.
- B. During Construction – During construction provide and maintain the following in accordance with Specification 20 0500 – Basic Requirements for Mechanical, Plumbing, and Fire Suppression:
1. Site Record Drawings - Maintain a set of drawings on site during construction showing the exact routing and location of piping systems being installed. The drawing shall be updated neatly by hand on a daily basis and account for routing modifications made in the field. Contractor shall use these drawing as a basis for generating the project as-built drawings.

- C. Contract Closeout – At contract closeout provide the following in accordance with Specification 20 0500 – Basic Requirements for Mechanical, Plumbing, and Fire Suppression:
 - 1. Operation and Maintenance Data including:
 - a. Product data
 - b. Installation instructions
 - c. Assembly views
 - d. Replacement parts list
 - e. Maintenance and operation instructions
 - 2. As-Built Drawings
 - a. Upon completion of project, Contractor shall furnish as-built drawings showing in scale the exact routing and locations of all newly installed piping systems. Submit in both hard-copy and electronic AutoCAD format.
 - 3. Test Reports
 - a. Pipe pressure test
 - b. Glycol concentration test
 - 4. Warranties

1.6 DELIVERY, STORAGE AND HANDLING

- A. Protect new pipe interiors from moisture, construction debris and dust, and other foreign materials with the use of plastic end caps/plugs on each end of pipe. Maintain end-caps/plugs in place until piping is installed. Open end of pipes should be capped/plugged throughout construction.
- B. Store materials indoors, protected from the weather. Where exterior storage is necessary, elevate piping above grade and enclose with waterproof wrapping or cover.
- C. Deliver and store valves in shipping containers with labeling in place.
- D. Replace any piping or devices which are damaged during shipping or storage.

1.7 SPARE PARTS

Not Applicable

1.8 WARRANTY

- A. One year warranty on products and complete installation commencing at the time of Substantial Completion

1.9 MAINTENANCE

Not Applicable

PART 2 - PRODUCTS

2.1 HEATING WATER PIPING, ABOVE GROUND

- A. Steel Pipe: ASTM A53/A53M, Grade B, Type E or S, Schedule 40, black steel with plain ends. Pipe 12" and over shall be standard weight, 0.375" wall thickness.
 - 1. Fittings and Joints
 - a. 2" and smaller: ANSI/ASTM B16.3 Class 150 malleable iron or ANSI/ASTM B16.4 Class 125 cast iron fittings. Threaded joints.
 - b. 2½" and larger: ASTM A234, wrought steel welding type fittings. ANSI/AWS D1.1 welded joints.
 - 2. Flanges and Flanged Fittings
 - a. ANSI/ASME B16.1, Class 125 raised face cast iron flanges
 - b. ANSI/ASME B16.5, Class 150 forged steel, raised face, welding neck flanges
 - c. Flanges to match those on valves and equipment
 - d. Slip-on steel flanges not allowed.
- B. Copper Tubing: ASTM B88, Type L hard drawn
 - 1. Fittings and Joints
 - a. ANSI/ASME B16.22 solder wrought copper fittings, ASTM B32, soldered joints, Grade 95TA
 - b. ANSI/ASME B16.15 screwed fittings and joints may be used at valves and equipment connections where required.
 - c. Pressure Seal Joints: The use of pressure seal joints as specified in paragraph titled "Pressure Seal Joints for Copper Tubing." Use of pressure seal joints is subject to the Owner's approval of voluntary alternate pricing.

2.2 DOMESTIC WATER MAKE-UP PIPING

- A. Copper Tubing: ASTM B88, Type L hard drawn
 - 1. Fittings and Joints
 - a. ANSI/ASME B16.22 solder wrought copper fittings, ASTM B32, soldered joints, Grade 95TA.
 - b. ANSI/ASME B16.15 screwed fittings and joints may be used at valves and equipment connections where required.
 - c. Pressure Seal Joints: The contractor may provide voluntary alternate pricing for the use of pressure seal joints as specified in paragraph titled "Pressure Seal Joints for Copper Tubing." Use of pressure seal joints is subject to the Owner's approval of voluntary alternate pricing.
- B. Galvanized Steel Pipe: ASTM A53, Schedule 40
 - 1. Fittings and Joints: Class 125 galvanized steel or cast iron. Joints: Screwed.

2.3 EQUIPMENT DRAIN PIPING

- A. Same materials and joining methods as for piping specified for the service in which the equipment drain is located.

2.4 FLANGES, UNIONS AND COUPLINGS

- A. Steel Pipe
 - 1. Unions 2" and Smaller: ANSI/ASME B16.39 malleable iron unions for threaded pipe, ground joint, screwed bronze or brass to iron. Pressure class and joint type of union shall be equal to that specified for fittings of respective piping service.
 - 2. Flanges 2½" and Larger: ANSI/ASME B16.5, forged steel, raised face, welding neck flanges. Pressure class and joint type of flange shall be equal to that specified for fittings of respective piping service.
 - 3. Slip on flanges are **not** allowed.
- B. Copper Pipe
 - 1. Unions 2" and Smaller: ANSI/ASME B16.15 bronze unions, soldered joints. Pressure class and joint type of union shall be equal to that specified for fittings of respective piping service.
 - 2. Flanges 2½" and Larger: ANSI/ASME B16.24 bronze flanges, soldered joints. Pressure class and joint type of flange shall be equal to that specified for fittings of respective piping service.
- C. Flanges to match those on valves and equipment.
- D. Flange Bolts and Nuts: ASME B18.2.1, carbon steel, unless otherwise indicated
- E. Pipe-Flange Gasket Materials
 - 1. Suitable for chemical and thermal conditions of piping system contents.
 - 2. ASME B16.21, nonmetallic, flat, asbestos free, 1/8" maximum thickness unless thickness or specific material is indicated.
 - a. Full-Face Type: For flat-face, Class 125, cast-iron and cast-bronze flanges.
 - b. Narrow-Face Type: For raised-face, Class 250, cast-iron and steel flanges.

2.5 DIELECTRIC FITTINGS

- A. Dielectric Nipples 4" and Smaller
 - 1. Acceptable Manufacturers: Flow Design Inc., Perfection Corporation, Victaulic.
 - 2. Electroplated steel nipple with inert and non-corrosive thermoplastic lining; threaded or grooved ends, 300-psig minimum working pressure at 225°F meeting the requirements of ASTM F-1545. Clearflow dielectric waterway fittings as manufactured by Perfection Corporation.

2.6 PRESSURE SEAL JOINTS FOR COPPER TUBING

- A. Acceptable Manufacturers
 - 1. Viega "Pro-Press"
 - 2. Nibco "Press System"
 - 3. Apollo "Xpress"
 - 4. No substitutions
- B. Pipe sizes ½" through 4": For use on ASTM B88, type L hard drawn piping
 - 1. Copper press fittings shall conform to the material and sizing requirements of ASME B16.18 or ASME B16.22 and performance criteria of IAPMO PS 117.

2. O-rings for copper press fitting shall be EPDM and shall be factory installed in fittings.
3. Fittings to incorporate Smart Connect "SC" feature that includes a leakage path that will not pass a pressure test unless properly pressed.
4. "Pro-press" as manufactured by Viega.

2.7 GLOBE VALVES

- A. Acceptable Manufacturers
 1. Crane
 2. Hammond
 3. Milwaukee
 4. Nibco
- B. Up to 2": Class 150, 300 psig CWP rated, manufactured in accordance with MSS-SP-80. ASTM B62 bronze body, union bonnet, bronze trim, rising bronze stem, malleable iron handwheel, asbestos free packing, renewable composition PTFE or TFE disc, screwed ends. Model 590T manufactured by Milwaukee.
- C. 2½" and greater: Class 125, 200 psig CWP rated manufactured in accordance with MSS-SP-85. ASTM A126 iron body, bolted bonnet, bronze trim, rising stem, cast iron handwheel, asbestos free packing OS&Y, solid disc, flanged end. Model F-2981-M manufactured by Milwaukee.

2.8 BALL VALVES

- A. Acceptable Manufacturers
 1. Apollo
 2. Crane
 3. Hammond
 4. Milwaukee
 5. Nibco
 6. Watts Regulator
- B. Up to 2½": 600 psi CWP rated, manufactured in accordance with MSS-SP-110. Two-piece bronze body, stainless steel full port vented ball, PTFE or TFE seats, lever handle and threaded ends. Model T-585-70-66 manufactured by Nibco.
- C. Ball valves mounted in insulated pipes shall have 2" extended stems of non-thermal conductive material to clear pipe covering, and a protective sleeve that allows operation of the valve without breaking the vapor seal or disturbing insulation.

2.9 BUTTERFLY VALVES – RESILIENT SEATED

- A. Acceptable Manufacturers
 1. Bray
 2. DeZurik
 3. Keystone/Tyco

4. Milwaukee (Standard Pressure only)
 5. Nibco
- B. Standard Pressure Butterfly Valves:
1. 2½" – 20": 250 psi CWP rated at temperatures up to 225°F, manufactured in accordance with MSS-SP-67, suitable for bi-directional bubble-tight and dead-end service at rated pressure without use of downstream flange. Cast iron or ductile iron body with lug ends, aluminum bronze or Nylon 11 coated ductile iron disc, blowout proof stainless steel stem, cured EPDM seat bonded or vulcanized to the body for service to 250°F, extended neck for insulating, 10 position lever handle for valves up to 6" in size. Series 31H manufactured by Bray.

2.10 SWING CHECK VALVES

- A. Acceptable Manufacturers
1. Crane
 2. Hammond
 3. Milwaukee
 4. Nibco
 5. Watts Regulator
- B. Up to 2": Class 150, 300 psig CWP rated, manufactured in accordance with MSS-SP-80. ASTM B62 bronze body, horizontal flow body design, PTFE or TFE seat disc, threaded ends. Model 510T manufactured by Milwaukee.
- C. 2½" and Greater: Class 125, 200 psig CWP rated, manufactured in accordance with MSS-SP-71. ASTM A126 iron body with clear or full waterway, bronze trim, cast iron disc, non-asbestos gasket, flanged ends. Model F-2974-M manufactured by Milwaukee.

2.11 SPRING LOADED CHECK VALVES

- A. Acceptable Manufacturers
1. Apco
 2. Hammond
 3. Metraflex
 4. Milwaukee
 5. Mueller
 6. Nibco
 7. Watts Regulator
 8. Victaulic
- B. Up to 2": Class 125, 250 psi CWP rated, manufactured in accordance with MSS-SP-80. ASTM B584 bronze body, wafer style, bronze seat, stainless steel spring, threaded ends. Model BSN manufactured by Metraflex.

- C. Over 2": Class 125, 200 psi CWP rated, manufactured in accordance with MSS-SP-125. ASTM A126 cast iron body, globe style, stainless steel seat and plug, stainless steel spring, flanged ends. Series 900 manufactured by Metraflex.

2.12 STRAINERS

- A. Acceptable Manufacturers
 - 1. Armstrong International
 - 2. Keckley
 - 3. Metraflex
 - 4. Spirax Sarco
 - 5. Titan Flow Control
 - 6. Victaulic
- B. Up to 2", Bronze Body: Class 125, rated for 200 psi @ 150F, ASTM B-584 bronze body, Y-pattern type with 20 mesh Type 304 stainless steel perforated screen, threaded cover for screen access and blow-off plug, threaded ends. Model F-150 manufactured by Keckley.
- C. Up to 2", Iron Body: Class 125, rated for 400 psi @150F, ASTM A126 cast iron body, Y pattern type with 20 mesh Type 304 stainless steel perforated screen, threaded cover for screen access and blow-off plug, threaded ends. Model TS manufactured by Metraflex.
- D. Size 2½" to 16": Class 125, rated for 175 psi @ 150F, ASTM A126 cast iron body, Y pattern type with 1/16" (sizes 2½" to 4") or 1/8" (sizes larger than 4") perforated Type 304 stainless steel screen, bolted cover for screen access and blow-off plug, flanged ends. Model YS58-CI manufactured by Titan Flow Control.
- E. Size 2" to 12" Low Pressure Drop Strainer: Class 125, rated for 175 psi @ 150F, ASTM A126 cast iron body, with 0.045" perforated Type 304 stainless steel screen, bolted cover for screen access and blow-off plug, flanged ends. Model LPD Y-strainer manufactured by Metraflex.
- F. All Y pattern strainers shall be provided with a ball valve and capped nipple on the blow-off connection.

2.13 MANUAL BALANCING VALVES

- A. Venturi Style
 - 1. Acceptable Manufacturers
 - a. Bell & Gossett (all sizes)
 - b. Griswold Controls (all sizes)
 - c. IMI Flow Design (all sizes)
 - d. Hays Fluid Controls (only up to 2")
 - e. Nexus Valve (only up to 2")
 - 2. Venturi flow measurement device with integral ball valve or butterfly valve furnished by the venturi manufacturer for flow adjustment.
 - 3. Sizes Up to 2": Brass or bronze body rated for 300 psi at 250°F, isolation ball valve with equal percentage port, Teflon seats and memory stop; venturi measurement device, dual temperature

and pressure test ports, threaded connections with union on inlet. Model QuickSet as manufactured by Griswold.

4. Sizes 2½" to 14": Steel body rated for 175 psi at 250°F, isolation butterfly valve with EPDM seat and memory stop, lever handle for valves up to 6" in size, gear drive and handwheel for valves 8" and larger; venturi measurement device, dual temperature and pressure test ports, flanged or grooved connections to match piping. Model QuickSet as manufactured by Griswold.
5. Provide extended neck test ports and extended handle valves to clear insulation for valves installed in insulated piping.
6. Valves shall be the same size as the piping in which installed.
7. Venturi measurement device shall have a precision machined throat and shall have a guaranteed accuracy of 3% across full operating range.
8. Pump Head Requirement: Select venturi Cv such that permanent pressure loss added to the pump head with the valve at the full open position does not exceed 2 ft.

2.14 MULTI-FUNCTION VALVE ASSEMBLIES

- A. Acceptable Manufacturers
 1. Anvil/Gruvlok (Red & White)
 2. Flow Design (Autoflow)
 3. Griswold Controls
 4. Hays Fluid Controls
 5. Nexus Valve
 6. Victaulic (Tour & Andersson)
- B. Manufacturer's packaged valve assemblies that combine multiple components and functions into a single device may be used for coil and equipment connections. Individual components shall be as specified in this Section.
- C. Valve assemblies shall include all components and devices shown on the drawings.

2.15 RELIEF VALVES

- A. Acceptable Manufacturers
 1. Amtrol
 2. Armstrong International
 3. Bell and Gossett
 4. Kunkle
 5. Spence
 6. Taco
 7. Watts Regulator
- B. Bronze or iron body, non-ferrous seat, diaphragm operated, non corrosive seat and stem designed for maximum working pressure of 125 psi.

- C. Valve Size, Capacity and Operating Pressure: Comply with ASME Boiler and Pressure Vessel Code – Section IV, and selected to suit system in which installed, with operating pressure and capacity factory set and field adjustable.
- D. Valves to bear ASME stamp, and meet all requirements of authority having jurisdiction.

2.16 PRESSURE REDUCING VALVES

- A. Acceptable Manufacturers
 - 1. Amtrol
 - 2. Armstrong Fluid Technology
 - 3. Bell and Gossett
 - 4. Spence
 - 5. Taco
 - 6. Watts Regulator
- B. Bronze or brass body, PTFE disc, brass seat, low inlet pressure check valve, inlet strainer which is removable without system shutdown.
- C. Valve size, capacity and operating pressure shall be selected to suit system in which installed, with operating pressure and capacity factory set and field adjustable.

2.17 AIR VENTS

- A. Acceptable Manufacturers
 - 1. Amtrol
 - 2. Armstrong International
 - 3. Bell and Gossett
 - 4. Spirotherm
 - 5. Taco
- B. Manual Type: Bronze body, threaded inlet connection, with 1/8" brass needle valve at top of chamber. Class 125, 150 psig CWP rated, maximum operating temperature 225°F.
- C. Automatic Float Type: Bronze or cast iron body, stainless steel float, stainless steel valve and valve seat. Class 125, 150 psig CWP rated, maximum operating temperature 250°F. Model 107A manufactured by Bell and Gossett.

PART 3 - EXECUTION

3.1 INSTALLATION

- A. Drawing plans, schematics, and diagrams indicate general location and arrangement of piping systems. Indicated piping locations and arrangements were used to size pipe and calculate friction loss, expansion, pump sizing, and other design considerations. Install piping as indicated unless deviations to layout are approved on Coordination Drawings.
- B. Protect new pipe interiors from moisture, construction debris and dust, and other foreign materials with the use of plastic end caps/plugs on each end of pipe. Maintain end-caps/plugs in place until piping is installed. Open end of pipes should be capped/plugged throughout construction.

- C. Install piping in concealed locations, unless otherwise indicated and except in equipment rooms and service areas.
- D. Install piping indicated to be exposed and piping in equipment rooms and service areas at right angles or parallel to building walls. Diagonal runs are prohibited unless specifically indicated otherwise.
- E. Install piping above accessible ceilings to allow sufficient space for ceiling panel removal.
- F. Install piping to permit valve servicing.
- G. Install piping at indicated slopes. Install piping at a uniform grade of 0.2% upward in direction of flow when no other slope is indicated on the drawings. Piping shall be installed to permit system drainage.
- H. Install piping free of sags and bends.
- I. Install fittings for changes in direction and branch connections.
- J. Install piping to allow application of insulation.
- K. Install groups of pipes at common elevations, parallel to each other, spaced to permit applying insulation and servicing of valves.
- L. Reduce pipe sizes using eccentric reducer fitting installed with level side up.
- M. Install branch connections to mains using tee fittings in main pipe.
 - 1. The use of saddle or "cut-in" connections is NOT allowed.
 - 2. The use of T-Drill connections is NOT allowed.
- N. The use of bullhead tee connections, where two opposite flows join to a common perpendicular outlet, is NOT allowed.
- O. Install ¾" nipple and ball valve in blowdown connection of strainers 2" and larger. Match size of strainer blowoff connection for strainers smaller than 2".
- P. Identify piping as specified in Division 20 Section 20 0553, "Identification for Mechanical, Plumbing, and Fire Suppression Systems."
- Q. Install piping to allow for expansion and contraction without stressing pipe, joints, or connected equipment.
- R. Install expansion loops, expansion joints, anchors, and pipe alignment guides as specified in Division 20 Section 20 0516, "Expansion Compensation for Mechanical, Plumbing, and Fire Suppression."
- S. Install pipe wells for temperature controls sensors and instrumentation. Coordinate with temperature controls contractor.
- T. Pipe Joint Construction
 - 1. Ream pipe and tube ends. Remove burrs. Bevel plain end ferrous pipe.
 - 2. Remove scale, slag, dirt, and debris from inside and outside of pipe and fittings before assembly.
 - 3. Soldered Joints: Apply ASTM B 813, water-flushable flux, unless otherwise indicated, to tube end. Construct joints according to ASTM B 828 or CDA's "Copper Tube Handbook," using lead-free solder alloy complying with ASTM B 32.
 - 4. Brazed Joints: Construct joints according to AWS's "Brazing Handbook," "Pipe and Tube" Chapter, using copper-phosphorus brazing filler metal complying with AWS A5.8.

5. Threaded Joints: Thread pipe with tapered pipe threads according to ASME B1.20.1. Cut threads full and clean using sharp dies. Ream threaded pipe ends to remove burrs and restore full ID. Join pipe fittings and valves as follows:
 - a. Apply appropriate tape or thread compound to external pipe threads unless dry seal threading is specified.
 - b. Damaged Threads: Do not use pipe or pipe fittings with threads that are corroded or damaged. Do not use pipe sections that have cracked or open welds.
 6. Welded Joints: Construct joints according to AWS D10.12/D10.12M, using qualified processes and welding operators according to Part 1 "Quality Assurance" Article.
 7. Flanged Joints: Select appropriate gasket material, size, type, and thickness for service application. Install gasket concentrically positioned. Use suitable lubricants on bolt threads.
 8. Plastic Piping Solvent-Cemented Joints: Clean and dry joining surfaces. Join pipe and fittings according to the following:
 - a. Comply with ASTM F 402 for safe-handling practice of cleaners, primers, and solvent cements.
 - b. CPVC Piping: Join according to ASTM D 2846/D 2846M Appendix.
 - c. PVC Pressure Piping: Join ASTM D 1785 schedule number, PVC pipe and PVC socket fittings according to ASTM D 2672. Join other-than-schedule number PVC pipe and socket fittings according to ASTM D 2855.
 - d. PVC Non-Pressure Piping: Join according to ASTM D 2855.
 9. Pressure Seal Joints
 - a. Pipe shall be certified for use with the copper pressure seal system.
 - b. Pipe shall be square cut, $\pm 0.030"$, properly deburred and cleaned.
 - c. Pipe ends shall be marked at the required location, using a manufacturer-supplied gauge, to ensure full insertion into the coupling or fitting during assembly.
 - d. Utilize press tool approved by fitting manufacturer.
 - e. Press tool shall leave identification mark such that use of proper tool can be visually verified.
- U. Coordination of mechanical work installation and access requirements:
1. Provide access where valves and fittings are not exposed. Coordinate size and location of access doors with Owner and General Contractor.
 2. Where pipes are to be installed in partitions, furred out spaces and chases, obtain information as to their exact location and size and install work so as to be entirely concealed in allotted space.
 3. Furnish advance information on locations and sizes of frames, boxes, sleeves and openings needed for work and also furnish information and shop drawings necessary to permit installation of other work without delay.
 4. Where there is evidence that parts of Mechanical Work will interfere with other work, assist in working out space conditions and/or structure, and make necessary adjustments to accommodate work.
 5. Mechanical Work installed before coordinating with other work so as to cause interference with other work to be changed to correct such condition without additional cost to Owner.

6. Install Mechanical work to permit removal (without damage to other parts) of coils, heat exchangers, pumps, fan shafts and wheels, belt guards, sheaves and drives and other parts requiring periodic replacement or maintenance.
 7. Arrange pipes, ducts and equipment to permit ready access to valves, cocks, traps, starters, motors, dampers, control components and to clear the openings of swinging and overhead doors and of access panels.
 8. Provide access panels in equipment, ducts and like items for inspection of interiors and proper maintenance.
- V. Provide sleeves when penetrating floors and walls. Refer to Division 20 Section 20 0517, "Penetrations for Mechanical, Plumbing, and Fire Suppression Systems."
- W. Seal pipe and sleeve penetration to achieve fire resistance equivalent to fire separation required. Refer to Division 20 Section 20 0517, "Penetrations for Mechanical, Plumbing, and Fire Suppression Systems."
- X. Appliances and equipment to be installed and connected with best engineering practices and in accordance with manufacturer's instructions and recommendations. Piping, valves, connections and other like items recommended by manufacturer or as required for proper operation to be provided without additional cost to Owner.
- Y. In no case will any pipe, conduit or duct be installed where it is supported on or suspended from another pipe, conduit or duct.
- Z. Follow manufacturers' directions in installation and operation of all equipment and materials.
- AA. Indirect waste lines, cooling coil drain pan lines, overflow pipes, relief valve discharge pipes, etc. shall have ends beveled at 45° angle to minimize splashing.
- BB. After completion or piping installation, clean, flush, and treat systems. Coordinate with chemical treatment requirements; refer to Division 23 Section 23 2500, "Pipe Cleaning, Flushing, and Chemical Treatment."
- CC. Valves
1. Examine valve interior for cleanliness. Clean or replace as required.
 2. Remove special packing materials from valves.
 3. Operate valves in positions from fully open to fully closed. Examine guides and seats made accessible by valve operation.
 4. Install valves with stems upright or horizontal, not inverted.
 5. Install valves in position to allow full movement and operation.
 6. Install chainwheels on operators for butterfly and other shut-off valves sizes 8" and over, installed 8'-0" or more above floor in mechanical rooms.
 7. Install swing check valves in horizontal position with hinge pin level.
- DD. Relief Valves
1. Provide safety relief valves for all closed loop hydronic systems, on boilers, pressure tanks, low pressure side of reducing valves, heat exchangers, expansion tanks, and elsewhere as indicated on plans or required by code.

2. Select system safety relief valve capacity so that it is greater than make up pressure reducing valve capacity. Select equipment relief valve capacity to exceed rating of connected equipment.
3. Pipe safety relief valve outlet to nearest floor drain.
4. Where one line vents several relief valves, make cross sectional area equal to sum of individual vent areas.

3.2 APPLICATIONS

- A. Select system components with pressure rating equal to or greater than system operating pressure.
- B. Install unions in piping 2" and smaller, adjacent to valves, at final connections of equipment, and elsewhere as indicated.
- C. Install flanges in piping 2½" and larger, at final connections of equipment and elsewhere as indicated.
- D. Install drains, consisting of a tee fitting, ¾" ball valve, and short threaded nipple with cap, at main shut off valves, low points of piping, bases of vertical risers, at equipment and elsewhere as required for system drainage.
- E. Provide manual air vents where shown on drawings and all high point of water systems, at heat transfer coils and elsewhere as required for air venting. Where large air quantities can accumulate in piping systems, provide enlarged air collection chambers.
- F. Install automatic air vents at high points of system piping in mechanical equipment rooms only and where indicated on the drawings. Provide vent tubing to nearest drain.
- G. Provide non conducting dielectric fittings wherever joining dissimilar metals.
- H. Piping to equipment shall be installed full size as indicated on the plans. If equipment connections differ from piping shown on the drawings, provide reducers/increasers at all valves, devices, and equipment as required.
- I. Install brass male adapters each side of valves in copper piped system. Sweat solder adapters to pipe.
- J. Multi-function valve assemblies may be used at coil and equipment connections at the contractor's option to reduce the number of joints which must be made in the field. These valve assemblies shall include all components and devices shown on the drawings.
- K. For new hydronic systems, make final connections to make-up water pipes provided by either plumbing or mechanical contractor as called for on the drawings.
- L. Use of pressure seal joints is subject to the Owner's approval of voluntary alternate pricing.
- M. Use ball valves for 2" and smaller; use butterfly valves for 2-1/2" and larger.
- N. Use venturi manual balancing valves for balancing.

3.3 WELDING

- A. All welding shall be performed by experienced welders in a neat and workmanlike manner. Welding done on piping, pressure vessels and structural steel under this section shall be performed only by persons who are currently qualified in accordance with ANSI Standard Code for Pressure Piping, Section I, Power Piping, Bulletin ANSI B31.1.0-1980; applicable portions of ASME Boiler and Pressure Vessel Code, Section I, Power Boilers, and Section IX, Welding Qualifications. Submit for approval and record certified copies of Procedure Specification for Welding, Welding Procedure Qualification Tests and Welder Performance Qualification Tests. Welding specifications and qualification tests shall be

recorded on Forms Q 1 as recommended in Appendix II of Section IX of the ASME Boiler and Pressure Vessel Code. Records shall be certified by Contractor and shall be accessible to authorized inspector.

- B. Bevel piping on both ends before welding as required and defined in Code.
- C. Use following weld spacing on all butt-welds:

NOMINAL PIPE WALL THICKNESS	SPACE
¼" or less	⅛"
Over ¼" or less than ¾"	⅜"
¾" and over	⅝"

- D. Use backing rings on welds in all piping 10" and larger.
- E. Where welding branches or connections are taken from a branch or main and the branch or connection pipe size is the same diameter as the main, a welding tee must be installed in the main for the branch or connection. Saddle or cut-in connections are NOT allowed.
- F. Where branches or connections are made to a welded main and the branch or connection is a minimum of two pipe sizes less than the diameter of the main, and the branch is 2½" and larger, install a Bonney-Forge weldolet at the branch connection to the main. Where the branch or connection is 2" and smaller, install a Bonney-Forge threadolet at the branch connection to the main. Screwed couplings, half couplings or screwed nipples welded to mains for screwed branches will not be permitted.
- G. The method of attaching weldolet or threadolet units to the piping shall be in strict accordance with the ANSI Code for Pressure Piping, B31.1.
- H. Before start of any welding, remove all corrosion and other foreign material from surface to be welded.
- I. Welding shall be performed by either manual shielded metallic arc process or automatic submerged arc process. Use direct current exclusively.
- J. Electrodes to be used with manual shielded metallic arc method shall conform to ASTM A-233, Classification E-6010.
- K. Size of electrodes, voltages, current, thickness, and number of passes or beads shall be in accordance with provisions of previous paragraph.
- L. After deposition, clean each layer of weld metal to remove all slab and scale by wire brushing or grinding, then chip where necessary to prepare for proper deposition of next layer.
- M. Weld reinforcement shall be not less than 1/16" or more than ⅛" above normal surface of joined sections. Reinforcement shall be crowned at center and shall taper on each side to surface being joined. Exposed surface of weld shall present workmanlike appearance and shall be free of depressions below surface of joined members.
- N. No welding of any kind shall be done when temperature of base metal is lower than 0°F. Material to be welded during freezing temperatures shall be made warm and dry before welding is started. Temperature of metal shall be "warm to hand" – or approximately 60°F.
- O. All welders engaged in work performed under this Section shall have been qualified in accordance with test requirements of Section IX of the ASME Boiler and Pressure Vessel Code. Each operator shall identify his production welds by marking his regularly assigned identification number or mark within 1" of weld. Contractor shall submit complete list of individual numbers of identifying marks and operator's name, and a copy of each operator's certificate.

3.4 START UP

- A. Prepare hydronic piping according to ASME B31.9 and as follows:
 - 1. Leave joints, including welds, uninsulated and exposed for examination during test.
 - 2. Provide temporary restraints for expansion joints that cannot sustain reactions due to test pressure. If temporary restraints are impractical, isolate expansion joints from testing.
 - 3. Flush hydronic piping systems with clean water; then remove and clean or replace strainer screens.
 - 4. Isolate equipment from piping. If a valve is used to isolate equipment, its closure shall be capable of sealing against test pressure without damage to valve. Install blinds in flanged joints to isolate equipment.
 - 5. Install safety valve, set at a pressure no more than one-third higher than test pressure, to protect against damage by expanding liquid or other source of overpressure during test.
- B. Perform the following before operating the system:
 - 1. Open manual valves fully.
 - 2. Inspect pumps for proper rotation.
 - 3. Set makeup pressure-reducing valves for required system pressure.
 - 4. Inspect air vents at high points of system and determine if all are installed and operating freely (automatic type), or bleed air completely (manual type).
 - 5. Set temperature controls so all coils are calling for full flow.
 - 6. Inspect and set operating temperatures of hydronic equipment, such as boilers, chillers, and cooling towers, to specified values.
 - 7. Verify lubrication of motors and bearings.

3.5 TESTING

- A. Pipe Pressure Test
 - 1. Furnish all labor, material, instruments, supplies and services and bear all costs for the accomplishment of tests herein specified. Correct all defects appearing under test and repeat the tests until no defects are disclosed; leave the equipment clean and ready for use.
 - 2. Field test all piping before start-up of systems. Tests of piping systems shall be conducted before connections to equipment are made and before piping is covered, buried or otherwise concealed.
 - 3. Perform all tests other than herein specified which may be required by legal authorities or by agencies to whose requirements this work is to conform.
 - 4. Furnish all necessary testing apparatus, make all temporary connections and perform all testing operations required, at no additional cost to Owner.
 - 5. No work shall be insulated, painted, backfilled or concealed until authorized by Owner's representative and/or the Engineer representative.
 - 6. Inform Engineer and Owner's representative 48 hours prior to when work is ready for test.

7. Systems found to have leaks shall be subjected to further tests when faulty joints have been repaired or replaced.
8. Contractor shall be responsible for any corrective action required due to a failed pipe pressure test.
9. Perform the following tests on hydronic piping:
 - a. Use ambient temperature water as a testing medium unless there is risk of damage due to freezing. Another liquid that is safe for workers and compatible with piping may be used.
 - b. While filling system, use vents installed at high points of system to release air. Use drains installed at low points for complete draining of test liquid.
 - c. Isolate expansion tanks and determine that hydronic system is full of water.
 - d. Subject piping system to hydrostatic test pressure that is not less than 1.5 times the system's working pressure or 100 psi, whichever is greater. Test pressure shall not exceed maximum pressure for any vessel, pump, valve, or other component in system under test. Verify that stress due to pressure at bottom of vertical runs does not exceed 90% of specified minimum yield strength or 1.7 times "SE" value in Appendix A in ASME B31.9, "Building Services Piping."
 - e. Test pressures shall be increased if necessary to comply with applicable codes.
 - f. After hydrostatic test pressure has been applied for at least 15 minutes, examine piping, joints, and connections for leakage. Eliminate leaks by tightening, repairing, or replacing components, and repeat hydrostatic test until there are no leaks.
10. Pipe Pressure Test Report - Submit documentation of pipe pressure testing and submit test result reports within two weeks of testing.

END OF SECTION

P:\22 Projects\P22-1142-00coev\04 Design\07 Specs\Div 23\23 2113-Hydronic Piping and Specialties.docx

SECTION 23 2500
PIPE CLEANING, FLUSHING AND CHEMICAL TREATMENT

PART 1 - GENERAL

1.1 SECTION INCLUDES

- A. Cleaning of piping systems
- B. Chemical feeder equipment
- C. Treatment for closed systems

1.2 SUBMITTALS

- A. Preconstruction – Prior to construction provide the following in accordance with Specification 20 0500 – Basic Requirements for Mechanical, Plumbing, and Fire Suppression:
 - 1. Manufacturer’s installation and operating manuals.
- B. Contract Closeout – At contract closeout provide the following in accordance with Specification 20 0500 – Basic Requirements for Mechanical, Plumbing, and Fire Suppression:
 - 1. Operating and Maintenance Data including:
 - a. Product data
 - b. Installation instructions
 - c. Assembly drawings
 - d. Replacement parts list
 - e. Maintenance and operation instructions
 - 2. Test Reports
 - a. Manufacturer Installation Inspection Report
 - b. Operational Test Report
 - c. Heating Water Analysis Test Report
 - 3. Warranties

1.3 OPERATION AND MAINTENANCE DATA

- A. Include data on chemical feed pumps, agitators and other equipment including spare parts lists, procedures and treatment programs.
- B. Include step by step instructions on test procedures including target concentrations.

1.4 QUALIFICATIONS

- A. Manufacturer: Company specializing in manufacturing the products specified in this Section with minimum ten years documented experience. Company shall have local representatives with water analysis laboratories and full time service personnel.

1.5 REGULATORY REQUIREMENTS

- A. Conform to applicable EPA code for addition of non-potable chemicals to building mechanical systems and for discharge to public sewage systems.

1.6 MAINTENANCE SERVICE

- A. Furnish service and maintenance of treatment systems for one year from Date of Substantial Completion.
- B. Provide monthly technical service visits to perform field inspections and make water analysis on-site. Detail findings in writing on proper practices, chemical treating requirements and corrective actions needed. Submit two copies of field service report after each visit.
- C. Provide laboratory and technical assistance services for warranty period.
- D. Include two hour training course for operating personnel, instructing them on installation, care, maintenance, testing and operation of water treatment systems. Arrange course at startup of systems.
- E. Provide on-site inspections of equipment during scheduled shutdown to properly evaluate success of water treatment program and make recommendations in writing based upon these inspections.

1.7 MAINTENANCE MATERIALS

- A. Provide sufficient chemicals for treatment and testing during warranty period.

PART 2 - PRODUCTS

2.1 MANUFACTURERS

- A. H-O-H Chemical
- B. Nalco Chemical
- C. Dearborn

2.2 MATERIALS

- A. All materials proposed must be compatible with existing treatment systems and chemicals.
- B. System Cleaner:
 - 1. Liquid alkaline compound with emulsifying agents and detergents to remove grease and petroleum products.
 - 2. Algaecide.
- C. Closed System Treatment (Water):
 - 1. Sequestering agent to reduce deposits and adjust pH
 - 2. Corrosion inhibitors.
 - 3. Conductivity enhancers.

2.3 EQUIPMENT

- A. Reuse existing equipment. Replace equipment where necessary.

2.4 TEST EQUIPMENT

- A. Reuse existing test kit. Replenish missing kits or supplies.

PART 3 - EXECUTION

3.1 PREPARATION

- A. Systems shall be operational, filled, started and vented prior to cleaning. Use water meter to record capacity in each system.
- B. Place terminal control valves in OPEN position during cleaning.

3.2 CLEANING SEQUENCE

- A. Add cleaner to closed systems at concentration as recommended by manufacturer.
- B. Hot Water Heating Systems: Apply heat while circulating, slowly raising temperature to 160°F and maintain for 12 hours minimum. Remove heat and circulate to 100°F or less; drain systems as quickly as possible and refill with clean water. Circulate for 6 hours at design temperatures, then drain. Refill with clean water and repeat until system cleaner is removed.
- C. Use neutralizer agents on recommendation of system cleaner supplier and approval of Owner.
- D. Remove, clean and replace strainer screens.
- E. Inspect, remove sludge and flush low points with clean water after cleaning process is completed. Include disassembly of components as required.

3.3 INSTALLATION

- A. Install in accordance with Owner's present practice and as directed by Owner.

3.4 CLOSED SYSTEM TREATMENT

- A. Provide one bypass feeder on each system. Install isolating and drain valves and necessary piping. Install around globe valve downstream of circulating pumps unless indicated otherwise.
- B. Introduce closed system treatment through bypass feeder when required or indicated by test.

3.5 WATER SYSTEMS

- A. Provide equipment and chemicals as required to increase existing system capacity to accommodate new work. Connections to new work shall match existing.

3.6 TESTING

- A. Manufacturer Installation Inspection Report - Provide report prepared by manufacturer's representative, stating that systems installed and services provided under this Section are in accordance with manufacturer's recommendations and are properly operating.
- B. Operational Test
 - 1. After the systems have been filled with water and the condenser pump(s) are operating, measure chemical treatment levels and verify proper operation of controller, chemical pumps and automatic bleed valve. Set the bleed and chemical feed rates to maintain the appropriate chemical levels.
 - 2. Operational Test Report - Submit documentation of operational testing and submit test result reports within two weeks of testing.

C. Heating Water Analysis Test

1. Sample heating water at one-week intervals after system start-up for a period of five (5) weeks, and prepare certified test report for each required water performance characteristic. Where applicable, comply with ASTM D 3370 and the following standards:
 - a. Silica: ASTM D 859.
 - b. Acidity and Alkalinity: ASTM D 1067.
 - c. Iron: ASTM D 1068.
 - d. Water Hardness: ASTM D 1126.
 - e. Chloride: ASTM D4458
 - f. Copper: ASTM D1688
 - g. pH: ASTM D5464
 - h. Conductivity: ASTM D5391

END OF SECTION

P:\22 Projects\22-1142-00coev\04 Design\07 Specs\Div 23\23 2500-Pipe Cleaning Flushing and Chemical Treatment.docx

SECTION 23 3113
METAL AND FLEXIBLE DUCT

PART 1 - GENERAL

1.1 SCOPE OF WORK

- A. Duct and duct-associated materials and procedures in this section include:
 - 1. Sheet metal materials
 - 2. Single-wall rectangular ducts and fittings
 - 3. Double-wall rectangular ducts and fittings
 - 4. Single-wall round ducts and fittings
 - 5. Double-wall round ducts and fittings
 - 6. Flexible ducts
 - 7. Duct liners
 - 8. Sealants and gaskets
 - 9. Hangers and supports
- B. Products/material specified under other Divisions but installed under this section:
 - 1. Duct-mounted smoke detectors
- C. Services provided
 - 1. Duct leak testing
 - 2. Removal of existing duct lining
 - 3. Duct cleaning

1.2 DEFINITIONS

- A. Duct Size: Duct sizes indicated herein or on associated drawings shall be the inside clear dimensions of actual air path for both unlined and lined ducts.
- B. Pressure Class: A "SMACNA - HVAC Duct Construction Standards, Metal and Flexible" pressure classification system designating static pressure values (in inches w.g.) equal to the maximum operating pressure to which the ductwork can safely be subjected.

1.3 CODES AND STANDARDS (USE LATEST EDITIONS)

- A. American Society for Testing Materials (ASTM)
 - 1. ASTM A 36/A 36M: Specification for Carbon Structural Steel
 - 2. ASTM A 366/A 366M: Specification for Steel, Sheet, Carbon, Cold-Rolled, Commercial Quality
 - 3. ASTM A 480/A 480M: Specification for General Requirements for Flat-Rolled Stainless and Heat-Resisting Steel Plate, Sheet, and Strip
 - 4. ASTM A 653/A 653M: Specification for Steel Sheet, Zinc-Coated (Galvanized) or Zinc-Iron Alloy-Coated (Galvannealed) by the Hot-Dip Process
 - 5. ASTM B 209: Specification for Aluminum and Aluminum-Alloy Sheet and Plate

6. ASTM C 203: Standard Test Methods for Breaking Load and Flexural Properties of Block-Type Thermal Insulation
 7. ASTM C209: Standard Test Methods for Cellulosic Fiber Insulating Board
 8. ASTM C 411: Test Method for Hot-Surface Performance of High-Temperature Thermal Insulation
 9. ASTM C 534: Specification for Preformed Flexible Elastomeric Cellular Thermal Insulation in Sheet and Tubular Form
 10. ASTM C 916: Specification for Adhesives for Duct Thermal Insulation
 11. ASTM C 920: Specification for Elastomeric Joint Sealants
 12. ASTM C 1071: Specification for Thermal and Acoustical Insulation (Glass Fiber, Duct Lining Material)
 13. ASTM D 256: Standard Test Methods for Determining the Izod Pendulum Impact Resistance of Plastics
 14. ASTM D 638: Standard Test Method for Tensile Properties of Plastics
 15. ASTM D 790: Standard Test Methods for Flexural Properties of Unreinforced and Reinforced Plastics and Electrical Insulating Materials
 16. ASTM D 1621: Standard Test Method for Compressive Properties of Rigid Cellular Plastics
 17. ASTM E 84: Test Method for Surface Burning Characteristics of Building Materials
- B. National Fire Protection Association (NFPA)
1. NFPA 90A: Installation of Air Conditioning and Ventilating Systems
 2. NFPA 90B: Installation of Warm Air Heating and Air Conditioning Systems
 3. NFPA 96: Ventilation Control and Fire Protection of Commercial Cooking Operations
 4. NFPA 255: Standard Method of Test of Surface Burning Characteristics of Building Materials
- C. North American Insulation Manufacturers Association (NAIMA)
1. NAIMA AH124: Fibrous Glass Duct Liner Standard
- D. Sheet Metal and Air Conditioning Contractors' National Association (SMACNA)
1. SMACNA: Duct Cleanliness for New Construction
 2. SMACNA: HVAC Air Duct Leakage Test Manual
 3. SMACNA: HVAC Duct Construction Standards - Metal and Flexible (excluding all amendments and proposed revisions)
 4. SMACNA: IAQ Guidelines for Occupied Buildings Under Construction
- E. Underwriters Laboratory
1. UL® 94: Standard for Tests for Flammability of Plastic Materials for Parts in Devices and Appliances
 2. UL® 181: Factory-Made Air Ducts and Air Connectors
 3. UL® 723: Test for Surface Burning Characteristics of Building Materials

1.4 QUALITY ASSURANCE

- A. Construct ductwork to NFPA 90A standards.
- B. Welding Qualifications: Qualify procedures and personnel according to the following:
 - 1. AWS D1.1/D1.1M, "Structural Welding Code - Steel," for hangers and supports.
 - 2. AWS D1.2/D1.2M, "Structural Welding Code - Aluminum," for aluminum supports.
 - 3. AWS D9.1M/D9.1, "Sheet Metal Welding Code," for duct joint and seam welding.
- C. Duct construction, including sheet metal thicknesses, seam and joint construction, reinforcements, and hangers and supports, shall, at a minimum, comply with SMACNA's "HVAC Duct Construction Standards - Metal and Flexible," excluding all amendments and proposed revisions, and performance requirements and design criteria indicated.
 - 1. All further references to conformance with the requirements of SMACNA's "HVAC Duct Construction Standards - Metal and Flexible" shall always mean with the exclusion of all amendments and proposed revisions.
 - 2. Where the requirements of this specification exceed the requirements of the SMACNA's "HVAC Duct Construction Standards - Metal and Flexible," the specifications shall govern.
- D. Size round ducts installed in place of rectangular ducts in accordance with ASHRAE table of equivalent rectangular and round ducts.
- E. Duct hangers and supports shall withstand the effects of gravity loads and stresses within limits and under conditions described in SMACNA's "HVAC Duct Construction Standards - Metal and Flexible."

1.5 SUBMITTALS

- A. Preconstruction – Prior to construction provide the following in accordance with Specification 20 0500 – Basic Requirements for Mechanical, Plumbing, and Fire Suppression:
 - 1. Product Data: Submit for each type of the following products:
 - a. Liners and adhesives.
 - b. Sealants and gaskets: submit manufacturer's data sheets including performance data, pressure ratings, surface burning characteristic and installation instruction.
 - 2. Shop Drawings: For all new duct systems submit layout drawings at $\frac{1}{4}'' = 1'-0''$ scale in both hard-copy and AutoCAD compatible format. Shop drawings shall include, but not be limited to:
 - a. Metal and flexible ductwork and fittings including both factory- and shop-fabricated
 - b. Fabrication, assembly, and installation, including plans, elevations, sections, components, and attachments to other work
 - c. Duct layout indicating sizes, configuration, liner material, and static-pressure classes
 - d. Elevation of ducts
 - e. Dimensions of main duct runs from building grid lines
 - f. Fittings
 - g. Reinforcement and spacing
 - h. Seam and joint construction
 - i. Penetrations through fire-rated and other partitions
 - j. Equipment installation based on equipment being used on Project

- k. Locations for duct accessories including dampers, turning vanes, and access doors and panels
 - l. Hangers and supports, including methods for duct and building attachment, and vibration isolation
 - m. Provide detail or schedule of:
 - (1) Sheet metal thicknesses
 - (2) Joint and seam construction and sealing
 - (3) Reinforcement details and spacing
 - (4) Materials, fabrication, assembly, and spacing of hangers and supports
 - n. Indicate all duct mounted equipment including fan coil units, reheat coils, terminal units, and humidifiers and indicate:
 - (1) Elevations, sections, details of components, manifolds
 - (2) Support types, locations, and weight on each support
 - (3) Required clearances
 - o. Shop drawings shall show other building and building system components for coordination purposes. Input from other installers shall be obtained. Any proposed changes to duct layout required for coordination purposes shall be indicated. Coordination items shown shall include but not be limited to:
 - (1) Any pipe (e.g., sprinkler, heating hot water, chilled water, plumbing pipes, roof drawings, etc.) in vicinity of duct
 - (2) Electrical duct banks and conduit
 - (3) Structural members including structural members to which duct will be attached
 - (4) Items penetrating finished ceiling including the following:
 - (a) Lighting fixtures
 - (b) Air outlets and inlets
 - (c) Speakers
 - (d) Sprinklers
 - (e) Access panels
3. Duct Testing Plan: Submit duct pressure testing plan with duct shop drawings, including list of ducts to be tested and duct testing schedule. Plan shall be color coded indicating areas to be tested in each phase of testing.
 - a. Notify engineer and owner of duct leakage testing schedule. Engineer shall be present at first duct leakage test per system.
 4. Manufacturer's installation and operating manuals.
 5. Welding Certificates
- B. During Construction – During construction provide and maintain the following in accordance with Specification 20 0500 – Basic Requirements for Mechanical, Plumbing, and Fire Suppression:
1. Site Record Drawings - Maintain a set of drawings on site during construction showing the exact routing and location of duct systems being installed. The drawing shall be updated neatly by hand on a daily basis and account for routing modifications made in the field. Contractor shall use these drawing as a basis for generating the project as-built drawings.

- C. Contract Closeout – At contract closeout provide the following in accordance with Specification 20 0500 – Basic Requirements for Mechanical, Plumbing, and Fire Suppression:
 - 1. Operation and Maintenance Data including:
 - a. Product data
 - b. Installation instructions
 - c. Assembly views
 - d. Replacement parts list
 - e. Maintenance and operation instructions
 - 2. As-Built Drawings
 - a. Upon completion of project, Contractor shall furnish as-built drawings showing in scale the exact routing and locations of all newly installed duct systems. Submit in both hard-copy and electronic AutoCAD format.
 - 3. Test Reports
 - a. Duct Testing Reports: Submit documentation of duct performance testing and submit performance testing result reports within two weeks of testing.
 - (1) Contractor shall be responsible for any corrective action required due to a failed duct leakage test.
 - 4. Warranties

1.6 DELIVERY, STORAGE AND HANDLING

- A. Protect new duct interiors from moisture, construction debris and dust, and other foreign materials. If inside of new duct becomes dirty, Contractor shall clean duct per Duct Cleaning specifications.
- B. Comply with SMACNA's "IAQ Guidelines for Occupied Buildings Under Construction," Intermediate Level.

1.7 WARRANTY

- A. One year warranty on products and complete installation commencing at the time of Substantial Completion.

PART 2 - PRODUCTS

2.1 SHEET METAL MATERIALS

- A. General Material Requirements: Comply with SMACNA's "HVAC Duct Construction Standards - Metal and Flexible" for acceptable materials, material thicknesses, and duct construction methods unless otherwise indicated. Sheet metal materials shall be free of pitting, seam marks, roller marks, stains, discolorations, and other imperfections.
 - 1. Galvanized Sheet Steel: Comply with ASTM A 653. Lock forming quality with G-90 galvanized coating designation (not less than 1.25 oz. of zinc on each side of each square foot of sheet).
 - 2. Paint Grip Steel; mill-phosphatized "Paintgrip" or "Zincgrip" finish suitable for field painting.
 - 3. Minimum ducts gauges shall be in accordance with the following tables. This table shall be used in conjunction with SMACNA table for application of appropriate reinforcement in accordance with proper pressure class.

MINIMUM GALVANIZED STEEL RECTANGULAR DUCT GAUGE WITHOUT REINFORCEMENT

DUCT DIMENSION (IN.)	1" W.G.	2" W.G.	3" W.G.	4" W.G.	6" W.G.
8 and under	26	26	24	24	24
9 - 10	26	26	24	22	24
11 - 12	26	26	24	22	20
13 - 14	26	24	22	20	20
15 - 16	26	24	22	20	18
17 - 18	24	22	20	18	18
19 - 20	24	20	18	18	16
21 - 22	22	18	18	18	16
23 - 24	22	18	18	18	16
25 - 26	20	18	18	16	
27 - 28	18	18	18	16	
29 - 30	18	18	18	16	
31 - 36	18	16	16		
37 - 42	16				
43 - 48	16				
49 - 54					
55 - 60					
61 - 72					
73 - 84					
85 - 96					
97 - 108					
109 - 120					

**REINFORCEMENT REQUIRED
REFER TO SMACNA HVAC DUCT CONSTRUCTION STANDARDS - METAL AND FLEXIBLE**

MINIMUM GALVANIZED STEEL ROUND DUCT GAUGE WITHOUT REINFORCEMENT

Duct Diameter (in.)	+10" w.g. Long Seam	+10" w.g. Spiral Seam	-2" w.g. Long Seam	-2" w.g. Spiral Seam	-4" w.g. Long Seam	-4" w.g. Spiral Seam	-6" w.g. Long Seam	-6" w.g. Spiral Seam
4	28	28	28	28	28	28	28	28
6	28	28	28	28	28	28	28	28
8	28	28	28	28	28	28	26	28
10	28	28	28	28	26	28	24	26
12	28	28	26	28	24	26	24	24
14	28	28	24	28	22	24	22	24
16	26	26	24	26	22	24	20	22
18	26	26	22	24	20	22	20	22
20	24	26	22	24	20	22	18	20
22	24	26	22	22	18	20	18	20
24	24	26	20	22	18	20	18	18
30	22	24	18	20	16	18	16	18
36	22	24	16	18		16		16
42	22	24	16	18		16		
48	20	22		16				

54	20	22	16
60	20	22	
66	18	22	
72	18	20	
78	18	20	
84	18	20	
90	18	20	
96	18	20	

REINFORCEMENT REQUIRED
REFER TO SMACNA HVAC DUCT
CONSTRUCTION STANDARDS - METAL AND FLEXIBLE

- B. PVC-Coated, Galvanized Sheet Steel: Comply with ASTM A 653. Galvanized steel sheet, lock forming quality with G-90 galvanized coating designation. Minimum thickness for factory-applied PVC coating shall be 4 mils (0.10 mm) thick on sheet metal surface of ducts and fittings exposed to corrosive conditions and on opposite surface.
 - 1. Coating Materials: Acceptable to authorities having jurisdiction for use on ducts listed and labeled by an NRTL for compliance with UL 181, Class 1.
 - 2. Minimum ducts gages shall be as per the minimum ducts gauges listed under Galvanized Sheet Metal.
- C. Carbon-Steel Sheets: Comply with ASTM A 1008/A 1008M, with oiled, matte finish for exposed ducts.
- D. Stainless-Steel Sheets: Comply with ASTM A 480 Type 304, 316 or 316L, as indicated in the "Duct Schedule" Article; cold rolled, annealed, sheet.
 - 1. Ductwork shall have Type 2B mill finish where concealed from view.
 - 2. Ductwork shall have Type 4 polished finish where exposed to view and located in finished building areas. All welds shall be ground and polished.
- E. Concrete Ducts: ASTM C14; hub and spigot concrete sewer pipe with ANSI/ASTM C443 joints, rubber gaskets.
- F. Fasteners: Rivets, bolts, or sheet metal screws.

2.2 SINGLE WALL RECTANGULAR DUCTS AND FITTINGS (SHOP AND FACTORY FABRICATED)

- A. Acceptable Manufacturers: Subject to compliance with requirements, provide products by one of the following:
 - 1. Lindab Inc.
 - 2. McGill AirFlow LLC.
 - 3. SEMCO Inc.
 - 4. Sheet Metal Connectors, Inc.
 - 5. Shop fabricated duct is acceptable for ducts with a pressures class rating of 6" w.g. or less provided compliance with the requirements herein are met.
- B. General Fabrication Requirements
 - 1. Comply with SMACNA's "HVAC Duct Construction Standards - Metal and Flexible" based on indicated static-pressure class unless otherwise indicated.
 - 2. Comply with SMACNA's "Industrial Duct Construction Standards" where indicated.

- C. Transverse Joints: Select joint types and fabricate according to SMACNA's "HVAC Duct Construction Standards - Metal and Flexible," Figure 1-4, "Transverse (Girth) Joints," for static-pressure class, applicable sealing requirements, materials involved, duct-support intervals, and other provisions in SMACNA's "HVAC Duct Construction Standards - Metal and Flexible" except as otherwise noted.
 - 1. No duct shall be constructed to less than 2" w.g.
- D. Longitudinal Seams: Select seam types and fabricate according to SMACNA's "HVAC Duct Construction Standards - Metal and Flexible," Figure 1-5, "Longitudinal Seams - Rectangular Ducts," for static-pressure class, applicable sealing requirements, materials involved, duct-support intervals, and other provisions in SMACNA's "HVAC Duct Construction Standards - Metal and Flexible," except as otherwise noted:
 - 1. Button Punch Snap Lock is not acceptable.
- E. Elbows, Transitions, Offsets, Branch Connections, and Other Duct Construction: Select types and fabricate according to SMACNA's "HVAC Duct Construction Standards - Metal and Flexible," Chapter 2, "Fittings and Other Construction," for static-pressure class, applicable sealing requirements, materials involved, duct-support intervals, and other provisions in SMACNA's "HVAC Duct Construction Standards - Metal and Flexible," except as otherwise noted.

2.3 SINGLE-WALL ROUND DUCTS AND FITTINGS (FACTORY AND SHOP-FABRICATED)

- A. Acceptable Manufacturers:
 - 1. Lindab Inc.
 - 2. McGill AirFlow LLC.
 - 3. SEMCO Inc.
 - 4. Sheet Metal Connectors, Inc.
 - 5. Shop fabricated ducts are acceptable for all positive pressure ducts and negative pressure ducts with ratings of -1" w.g. to -4" w.g.
- B. General Fabrication Requirements: Comply with SMACNA's "HVAC Duct Construction Standards - Metal and Flexible," Chapter 3, "Round, Oval, and Flexible Duct," based on indicated static-pressure class unless otherwise indicated.
 - 1. All round ducts must utilize spiral lock seam except:
 - a. Ducts up to and including 12" diameter with a positive pressure class of 2" w.g. and less may utilize longitudinal lock seam construction.
- C. SMACNA's "HVAC Duct Construction Standards - Metal and Flexible," Figure 3-2, "Transverse Joints - Round Duct," for static-pressure class, applicable sealing requirements, and materials involved, duct-support intervals, and other provisions in SMACNA's "HVAC Duct Construction Standards - Metal and Flexible."
 - 1. Transverse joints in ducts larger than 60" in diameter shall be flanged.
- D. Longitudinal Seams: Select seam types and fabricate according to SMACNA's "HVAC Duct Construction Standards - Metal and Flexible," Figure 3-1, "Seams - Round Duct and Fittings," for static-pressure class, applicable sealing requirements, materials involved, duct-support intervals, and other provisions in SMACNA's "HVAC Duct Construction Standards - Metal and Flexible."
 - 1. Fabricate round ducts larger than 48" in diameter with butt-welded longitudinal seams.

- E. Tees and Laterals: Select types and fabricate according to SMACNA's "HVAC Duct Construction Standards - Metal and Flexible," Figure 3-4, "90 Degree Tees and Laterals," and Figure 3-5, "Conical Tees," for static-pressure class, applicable sealing requirements, materials involved, duct-support intervals, and other provisions in SMACNA's "HVAC Duct Construction Standards - Metal and Flexible."

2.4 SEALANT AND GASKETS

- A. Acceptable Manufacturers for Duct Sealant:
 - 1. Hardcast
 - 2. United McGill
 - 3. Ductmate
- B. General Sealant and Gasket Requirements: Surface-burning characteristics for sealants and gaskets shall be a maximum flame-spread index of 25 and a maximum smoke-developed index of 50 when tested according to UL 723; certified by an NRTL.
- C. Duct Sealant:
 - 1. Water-based non hardening, water resistant, mold and mildew resistant sealant classified compounded specifically for sealing joints and seams in ductwork.
 - a. Maximum Static-Pressure Class: 10" w.g., positive and negative.
 - b. Service: Indoor or outdoor.
 - c. Substrate: Compatible with galvanized sheet steel (both PVC coated and bare), stainless steel, or aluminum sheets for specific applications.
 - 2. Duct tapes are not allowed.
- D. Flanged Joint Sealant: Comply with ASTM C 920. General: Single-component, acid-curing, silicone, electrometric. Type S, Grade NS, Class 25, Use O.
- E. Flange Gaskets: Butyl rubber, neoprene, or EPDM polymer with polyisobutylene plasticizer.
 - 1. Gaskets used in chemical, laboratory, or process exhaust duct systems shall be suitable for exposure to substances in the air stream. Contractor shall verify the compatibility with Engineer prior to installation.

2.5 HANGERS AND SUPPORTS

- A. Hanger Rods for Dry or Non-corrosive Environments: Cadmium-plated steel rods and nuts.
- B. Hanger Rods for Moist or Corrosive Environments: Electrogalvanized, all-thread rods or galvanized rods with threads painted with zinc-chromate primer after installation.
- C. Steel Cables for Galvanized-Steel Ducts: Galvanized steel complying with ASTM A 603.
- D. Steel Cables for Stainless-Steel Ducts: Stainless steel complying with ASTM A 492.
- E. Steel Cable End Connections: Cadmium-plated steel assemblies with brackets, swivel, and bolts designed for duct hanger service; with an automatic-locking and clamping device.
- F. Trapeze and Riser Supports:
 - 1. Supports for Galvanized-Steel Ducts: Galvanized-steel shapes and plates.
 - 2. Supports for Stainless-Steel Ducts: Stainless-steel shapes and plates.
 - 3. Supports for Aluminum Ducts: Aluminum or galvanized steel coated with zinc chromate.

PART 3 - EXECUTION

3.1 APPLICATION

- A. Install duct with duct material for pressure class as per the following table:

DUCT SYSTEM AND LOCATION	MATERIAL	PRESSURE CLASS
Outside air and exhaust plenums	Galvanized steel (G90)	-2"

3.2 INSTALLATION

- A. General
1. Drawing plans, schematics, and diagrams indicate general location and arrangement of duct system. Where interferences develop in field, offset or reroute ductwork as required for clearing such interference.
 2. Contractor shall modify specified duct sizes as required to fit. Modified duct size shall have cross-sectional area and pressure drop equivalent to that of the specified duct size.
 3. All ducts shall be airtight and free from pulsation and vibration at normal operating conditions.
 4. Contractor shall submit sheet metal shop drawings to the Test and Balance Contractor for review, and provide any additional volume dampers that the Test and Balancing Contractor needs to perform final balancing.
 5. Install round ducts in maximum practical lengths.
 6. Install ducts with fewest possible joints.
 7. Unless otherwise indicated, install ducts vertically and horizontally, and parallel and perpendicular to building lines.
 8. Install ducts close to walls, overhead construction, columns, and other structural and permanent enclosure elements of building.
 9. Install ducts with a minimum clearance of 1", plus allowance for insulation thickness.
 10. Locate ducts with sufficient space around equipment to allow normal operating and maintenance activities.
 11. Route ducts to avoid passing through transformer vaults and electrical equipment rooms and enclosures.
 12. Where ducts pass through non-fire-rated interior partitions and exterior walls and are exposed to view, cover the opening between the partition and duct or duct insulation with sheet metal flanges of same metal thickness as the duct. Overlap openings on four sides by at least 1½".
 13. Where ducts pass through fire and smoke rated interior partitions and exterior walls, install fire, smoke, and/or combination fire/smoke dampers. Contractor shall obtain a copy of architectural drawings showing the fire and smoke rated partitions and exterior walls at the time of bid and provide the appropriate damper (at all ducts penetrating fire and smoke rated partitions and walls whether shown on mechanical plans or not). Comply with requirements in Division 23 Section "Ductwork Accessories" for fire and smoke dampers.
 14. Provide openings in ducts where required to accommodate thermometers and controllers. Provide pitot tube openings where required for testing of systems, complete with metal can

with spring device or screw to ensure against air leakage. Where openings are provided in insulated ducts, install insulation material inside a metal ring.

15. Fabricate continuously welded medium and high pressure round duct fittings two gauges heavier than duct gauges indicated in SMACNA Standard. Joints shall be minimum 4" cemented slip joint, brazed or electric welded. Prime coat welded joints.
16. Install duct-mounted smoke detectors.
17. Where ducts of different metals meet, joint shall use a gasket, seal or compound to prevent the two different metals from coming in contact.
18. Galvanized surfaces altered or damaged (including the damage due to welding) shall be painted with a galvanized paint.
19. For paint grip steel ducts, place identification stickers in side ducts off of the surface to be painted.
20. Gaskets shall not protrude into airstream.
21. Elbows:
 - a. Rectangular Duct: Comply with SMACNA's "HVAC Duct Construction Standards - Metal and Flexible," Figure 2-2, "Rectangular Elbows."
 - (1) For supply duct:
 - (a) Use Radius Type RE 1 with minimum 1.5 radius-to-diameter ratio.
 - (b) If space does not allow the use of a Radius Type RE1, provide a square-throated elbow with turning vanes. Turning vanes shall comply with the requirements of Division 23 Section "Ductwork Accessories".
 - (2) For return and exhaust duct:
 - (a) Use Radius Type RE 1 with minimum 1.5 radius-to-diameter ratio.
 - (b) If space does not allow the use of a Radius Type RE1, provide a square-throated elbow with vanes. Turning vanes shall comply with the requirements of Division 23 Section "Duct Accessories."
 - b. Round Duct, excluding laboratory (fume handling) exhaust duct: Comply with SMACNA's "HVAC Duct Construction Standards - Metal and Flexible," Figure 3-3, "Round Duct Elbows."
 - (1) Use minimum 1.5 radius-to-diameter ratio.
 - (a) 12" and Smaller in Diameter: Stamped (pleated not acceptable)
 - (b) 14" and Larger in Diameter: Standing seam or welded five-piece 90° turning elbows (three-piece elbows not acceptable for 90° elbow).
 - (c) 45° elbows shall meet the requirements for 90° elbows and shall be die stamped up to 12" and three piece construction of sized greater than 12".
22. Branch Configurations:
 - a. Rectangular Duct: Comply with SMACNA's "HVAC Duct Construction Standards - Metal and Flexible," Figure 2-6, "Branch Connections."
 - (1) Rectangular main to rectangular branch: 45° entry.
 - (2) Rectangular main to round branch: Bellmouth connection. A 45° boot connection is allowed only where the duct main size does not allow the use of a Bellmouth branch connection.
 - (3) No straight tap, butt flange or cinch lock is allowed

- b. Round Duct: Comply with SMACNA's "HVAC Duct Construction Standards - Metal and Flexible," Figure 3-4, "90 Degree Tees and Laterals," and Figure 3-5, "Conical Tees."
 - (1) Provide 45° lateral tap; conical taps are allowed only on supply duct downstream of air terminal units and return ducts upstream of air terminal units.
 - (2) Saddle taps are permitted only for new connection in existing duct.
 - (3) No 90° taps are allowed.
23. Offsets and transitions: Comply with SMACNA's "HVAC Duct Construction Standards - Metal and Flexible," Figure 2-7, "Offsets and Transitions."
- a. Transitions:
 - (1) Increase duct sizes gradually, not exceeding 15° on each side for a concentric transition or 30° on one each side for an eccentric transition.
 - (2) Decrease duct sized not exceeding 22.5° on each side for a concentric transition or 45° on one side for an eccentric transition.
 - b. Offsets:
 - (1) Provide smooth radius offset with the radius equal to the duct dimension.
 - (2) Mitered offset Type 2 is acceptable provided the offset angle no greater than 15°.
24. Easements for obstructions:
- a. Provide easements where ductwork conflicts with piping and structure.
 - b. Where easements exceed 10% duct area, split into two ducts maintaining original duct area.
25. Seam and joint sealing:
- a. For **all new ducts**, all transverse joints, longitudinal seams and connections shall be sealed in conformance with SMACNA Class A sealing requirements as defined in the 2005 SMACNA HVAC Duct Construction Standards - Metal and Flexible, Second Edition.
26. Hangers and supports: Comply with SMACNA's "HVAC Duct Construction Standards - Metal and Flexible," Chapter 5, "Hangers and Supports."
- a. Refer to Division Section 20 0529 "Hangers and Supports for Mechanical, Plumbing and Fire Suppression Systems" for additional information.
 - b. Support ducts using traverse steel and threaded rods or 1" wide straps of 16 gauge galvanized steel. Wire or perforated straps of any kind are not acceptable.
 - c. No hangers and supports shall be attached to ducts with sheet metal screws that penetrate any part of ducts.
 - d. Round duct shall be suspended on prefabricated circular single loop or two-piece bands completely encircling ducts.
 - e. Hanger Spacing: Except where requirements herein exceed, comply with SMACNA's "HVAC Duct Construction Standards - Metal and Flexible," Table 5-1, "Rectangular Duct Hangers Minimum Size," and Table 5-2, "Minimum Hanger Sizes for Round Duct,"
 - (1) Provide duct supports at a maximum of 6 foot intervals, within 24" of each elbow, and within 24" of each branch intersection.
 - (2) Provide vertical ducts supports at a maximum of 10 foot intervals.

27. Access Panels
 - a. Locate access openings on top or sides of duct, whichever is more accessible. Side openings shall be a minimum of 1½" from bottom of duct.
 - b. Install fire-rated access panel assemblies within 10 feet of each change in direction and at maximum intervals of 12 feet in horizontal ducts, and at every floor for vertical ducts, or as indicated on Drawings.
 - c. Install access panels within 3 feet of each side of fan where the fan has ductwork connected to both the inlet and outlet.
 - d. Install an access panel within 3 feet of a wall mounted exhaust fan.
 - e. Access panels shall be installed liquid tight.
 - f. Access panels shall have a gasket or sealant that is rated for 1500F.

3.3 TESTING

A. Duct Leakage Tests

1. The following shall be the scope of the new duct leakage testing:
 - a. All new duct with a pressure class of +3" w.g. and greater, or 3" w.g. and lower.
 - b. All duct of any pressure class that will be located outdoors.
 - c. All duct of any pressure class that will be located in an inaccessible area (e.g. in shafts, above plaster ceilings).
 - d. A sampling of approximately 100% of duct constructed to a pressure class ranging from -2" w.g. through +2" w.g. (e.g. duct downstream of supply air terminal units).
 - (1) If sample passes tests, remaining ductwork of similar pressure class shall be permitted to proceed without further testing.
 - (2) If sample fails leak test, the sample duct shall be repaired and the leakage test repeated until test passes. Any other duct of similar pressure class that was installed will be repaired in a similar manner.
2. Ducts shall be tested in accordance with the SMACNA HVAC Air Duct Leakage Test Manual Leak Testing procedure. Leaks or imperfections that are detected shall be properly remedied and the tests repeated until all work is reasonably sound.
3. Notify engineer and owner of duct leakage testing schedule. Engineer shall be present at first duct leakage test per system.
4. Air leakage shall not exceed maximum allowable leakage for specified Leakage Class CL as defined in SMACNA "HVAC Air Duct Leakage Test Manual," most recent edition.
 - a. ASHRAE / SMACNA Leakage Class is defined by:

$$F = C_L \times P^{0.65}$$

$$Q = F \times A$$

Where:

F Leakage flow rate (cfm per 100 ft² of duct surface area)

C_L Leakage Class

P Test static pressure (in. w.g.)

Q Total leakage rate (cfm)

A Duct surface area (ft²)

b. Leaking rates shall be in conformance with the Leakage Class shown in the table below:

DUCT CONSTRUCTION PRESSURE RATING	SMACNA LEAKAGE CLASS CL
+3" w.g. and greater	4
-3' w.g. and lower	
From -2" w.g to +2" w.g	6
Welded ducts	No leakage

5. There shall be no audible leaks.
6. A duct system need not be completed before tests are conducted. Sections may be temporarily blanked off or suitably capped, etc., and such sections individually tested as specified. All equipment, portable blower, instruments, temporary connections, blank-offs, etc., necessary to conduct tests as specified shall be provided by the Contractor, and the costs of which shall be included in the Contractor's original bid for the work, without any additional costs to Owner.
7. Ductwork shall be pressure tested to a pressure equal to the specified duct construction pressure (i.e., a duct built to a 3" standard shall be tested to 3").
8. Air measuring stations used for temperature control purposes are not to be used to measure leakage.
9. Contractor shall be responsible for any corrective action required due to a failed duct leakage test. Ductwork shall be re-tested after corrective actions are taken until the leakage test is passed.
10. Duct Leakage Test Report - Submit documentation of duct leakage testing and submit test result reports within two weeks of testing.

END OF SECTION

P:\22 Projects\P22-1142-00coev\04 Design\07 Specs\Div 23\23 3113-Metal and Flexible Duct.docx

SECTION 23 5100
BREECHINGS, CHIMNEYS, AND STACKS

PART 1 - GENERAL

1.1 SCOPE OF WORK

- A. This Section includes the following:
 - 1. Listed Double Wall Special Gas Vents

1.2 DEFINITIONS

- A. Breechings, or vent connectors, are pipes or ducts that connect fuel-fired-appliances to vents, chimneys, or stacks. Breechings are mostly horizontal.
- B. Chimneys and vents are the generally more vertical parts of venting systems that conduct flue gases to the outside.
- C. Vents are flue-gas conveying systems intended for use with fuel-fired appliances that produce flue gas at less than 600°F. Vents are listed systems composed of factory-fabricated components assembled according to the terms of the vent listing.
- D. Vent Connector: That part of a venting system that conducts the flue gases from the flue collar of an appliance to a chimney or vent and may include a draft control device.

1.3 CODES AND STANDARDS

- A. American Society of Mechanical Engineers (ASME)
 - 1. ASME B16.5: Pipe Flanges and Flanged Fittings, NPS 1/2 to NPS 24
 - 2. ASME B16.9: Factory Made Wrought Steel Buttwelding Fittings
 - 3. ASME STS-1: Steel Stacks
- B. American Society for Testing and Materials (ASTM)
 - 1. ASTM A 53/A 53M: Specification for Pipe, Steel, Black and Hot-Dipped, Zinc-Coated, Welded and Seamless
 - 2. ASTM A90: Weight of Coating on Zinc-Coated (galvanized) Iron or Sheet Articles.
 - 3. ASTM A 106: Specification for Seamless Carbon Steel Pipe for High-Temperature Service
 - 4. ASTM A167: Stainless and Heat Resisting Chromium-Nickel Steel Plate, Sheet and Strip.
 - 5. ASTM A 240/A 240M4: Specification for Chromium and Chromium-Nickel Stainless Steel Plate, Sheet, and Strip for Pressure Vessels and for General Applications
 - 6. ASTM A525: Steel Sheet, Zinc Coated (Galvanized) by the Hot Dip Process, General Requirements.
 - 7. ASTM A527: Steel Sheet, Zinc Coated (Galvanized) by the Hot Dip Process, Lock Forming Quality.
 - 8. ASTM A569: Steel, Sheet and Strip, Carbon (0.15 Maximum Percent) Hot Rolled Commercial Quality.
 - 9. ASTM A 666: Specification for Annealed or Cold-Worked Austenitic Stainless Steel Sheet, Strip, Plate, and Flat Bar

10. ASTM A 959: Guide for Specifying Harmonized Standard Grade Compositions for Wrought Stainless Steels
 11. ASTM A 1011/A: Specification for Steel, Sheet and Strip, Hot-Rolled, Carbon, Structural, High-Strength Low-Alloy and High-Strength Low-Alloy with Improved Formability
 12. ASTM B 209-02a: Specification for Aluminum and Aluminum-Alloy Sheet and Plate
 13. ASTM C64: Refractors for Incinerators and Boilers.
 14. ASTM C105: Ground Fire Clay as a Refractory Mortar for Laying up Fireclay Brick.
 15. ASTM C401: Classification of Castable Refractors.
- C. American National Standards Institute (ANSI)
1. ANSI Z21.66: Electrically Operated Automatic Vent Damper Devices for Use with Gas Fired Appliances.
 2. ANSI Z21.67: Mechanically Actuated Automatic Vent Damper Devices for Use with Gas Fired Appliances.
 3. ANSI Z21.68: Thermally Operated Automatic Vent Damper Devices for Use with Gas Fired Appliances.
 4. ANSI Z95.1 (NFPA 31): Standard for the Installation of Oil Burning Equipment.
 5. ANSI Z181.1 (UL 959): Medium Heat Appliance Factory Built Chimneys.
 6. ANSI Z223.1 (NFPA 54): The National Fuel Gas Code.
- D. American Society of Heating, Refrigerating and Air Conditioning Engineers (ASHRAE)
1. ASHRAE Handbook, Equipment Volume, Chapter "Chimney, Gas, Vent and Fireplace Systems."
- E. American Welding Society (AWS)
1. AWS D1.1/D1.1M-04: Structural Welding Code - Steel
 2. AWS D9.1M/D9.1-00: Sheet Metal Welding Code
- F. National Fire Protection Association (NFPA)
1. NFPA 31: Installation of Oil Burning Equipment
 2. NFPA 37: Standards for Installation and Use of Stationary Combustion Engines and Gas Turbines.
 3. NFPA 54: National Fuel Gas Code
 4. NFPA 82: Standard on Incinerators, Waste and Linen Handling Systems and Equipment.
 5. NFPA 96: Ventilation Control and Fire Protection of Commercial Cooking Operations
 6. NFPA 97: Chimneys, Vents and Heat-Producing Appliances
 7. NFPA 211: Standard for Chimneys, Fireplaces, Vents and Solid Fuel Burning Appliances.
- G. Sheet Metal and Air Conditioning Contractors' National Association (SMACNA)
1. SMACNA HVAC Duct Construction Standards, Metal and Flexible.
 2. Guide for Steel Stack Design and Construction

- H. Underwriters Laboratories Inc. (UL®)
 - 1. UL 103: Standard for Factory Built Low Heat Chimneys.
 - 2. UL 127: Standard for Factory Built Fireplaces.
 - 3. UL 378: Standard for Draft Equipment.
 - 4. UL 441: Standard for Gas Vents.
 - 5. UL 641: Standard for Low Temperature Venting Systems.
 - 6. UL 959: Standard for Factory Built Medium Heat Chimneys.
 - 7. UL 1738: Venting Systems for Gas Burning Appliances, Categories II, III, and IV
 - 8. UL 1777: Chimney Liners
 - 9. UL 1978: Grease Ducts

1.4 QUALITY ASSURANCE

- A. Source Limitations: Obtain listed system components from the appliance outlet to the termination point, including all accessories, through one source from a single manufacturer.
- B. Each vent and chimney section shall bear factory applied UL label.
- C. Welding: Qualify procedures and personnel according to AWS D1.1/D1.1M, "Structural Welding Code-Steel," for hangers and supports and AWS D9.1/D9.1M, "Sheet Metal Welding Code," for shop and field welding of joints and seams in vents, breechings, and stacks.
- D. Certified Sizing Calculations: Manufacturer shall certify venting system sizing calculations.
- E. Conform to ANSI Z223.1/NFPA 54 code for installation of natural gas burning appliances and equipment.
- F. Conform to ANSI Z95.1/NFPA 31 code for installation of oil burning appliances and equipment.

1.5 SUBMITTALS

- A. Preconstruction – Prior to construction provide the following in accordance with Specification 20 0500 – Basic Requirements for Mechanical, Plumbing, and Fire Suppression:
 - 1. Product Data: For each type of product provide the following product data:
 - a. Materials of construction
 - b. Finish
 - c. Fittings and accessories
 - d. Mounting details
 - e. Performance data
 - f. Guy wires and connectors
 - 2. Shop Drawings: For vents, breechings, and chimneys. Include plans, elevations, sections, details, and attachments to other work.
 - a. Detail equipment assemblies and indicate dimensions, weights, loads, required clearances, methods of field assembly, components, hangers and seismic restraints, and location and size of each field connection.
 - b. Submit layout Drawings indicating plan view and elevations.

- c. For installed products indicated to comply with design loads, include calculations required for selecting seismic restraints and structural analysis data signed and sealed by the qualified professional engineer responsible for their preparation.
 3. Welding certificates.
 - a. Dimensioned Outline Drawings of Breeching, Chimneys, and Stacks: Identify center of gravity and locate and describe mounting and anchorage provisions.
 - b. Detailed description of anchorage devices on which the certification is based and their installation requirements.
- B. Contract Closeout – At contract closeout provide the following in accordance with Specification 20 0500 – Basic Requirements for Mechanical, Plumbing, and Fire Suppression:
 1. Operating and Maintenance Data including:
 - a. Product data
 - b. Installation instructions
 - c. Assembly drawings
 - d. Replacement parts list
 - e. Maintenance and operation instructions
 2. Test Reports
 - a. Manufacturer Installation Inspection Report
 3. Warranties

1.6 DELIVERY, STORAGE AND HANDLING

- A. Ship in packaging to prevent damage during shipping.
- B. Materials shall be protected (interior and exterior surfaces) from dirt and moisture prior to installation. No internal insulation shall be exposed.

1.7 WARRANTY

1. Listed Double Wall Special Gas Vents:
 - a. Warranty Period 15 years from date of Substantial Completion.
 - b. Leak-free Warranty Period: 5 years from the date of system start-up.

1.8 MAINTENANCE

- A. Submit manufacturer's descriptive literature, operating instructions and maintenance and repair data.

PART 2 - PRODUCTS

2.1 LISTED DOUBLE WALL SPECIAL GAS VENTS

- A. Acceptable Manufacturers:
 1. Dura Vent
 2. Heat-Fab, Inc.
 3. Schebler Co.

- B. Description: Double-wall metal vents tested according to UL 1738 for use for use with Category 2, 3 and 4 appliances and rated for 480F continuously, with positive or negative flue pressure complying with NFPA 211.
- C. Construction: Inner shell and outer jacket separated by a 1" minimum air space between walls. Inner and outer jackets shall be connected by means of spacer clips that maintain the concentricity of the annular space and allow unobstructed differential thermal expansion of the inner and outer walls.
- D. Inner shell: ASTM A-959, AL-29-4C superferritic stainless steel, .015 thickness for 6"-12" and .024 thickness for 14"-24" diameters.
- E. Outer Jacket
 - 1. Aluminized steel outer jacket for materials located indoors.
 - 2. Type 304, 316 or 430 stainless steel outer jacket for materials located outdoors.
- F. Vent shall be listed for an internal static pressure of 6" w.g. and shall be tested to 15" w.g.
- G. All inner vent connections shall be secured by means of profiled connector bands with gear clamp tighteners. Joints shall be sealed with a UL listed and tested gasket incorporated into the product and shipped mounted with the product. Where exposed to the weather, the outer closure band shall be sealed to prevent rainwater from entering the space between inner and outer walls.
- H. The vent system shall be designed to compensate for all flue gas induced thermal expansion. Provide expansion joints as required.
- I. Provide a custom support plate at the bottom of each riser.
- J. Provide a Half Ring horizontal support minimum every 12 feet and within 1 foot of each change in direction.
- K. Provide a vertical floor/roof guide at every floor.
- L. Accessories: Provide accessories by same manufacturer as piping, each bearing factory applied UL label. Provide all accessories required for a complete installation; including but not limited to: tees, elbows, increasers, terminations, adjustable roof flashings, storm collars, support assemblies, thimbles, firestop spacers, and fasteners; fabricated from similar materials and designs as vent-pipe straight sections; all UL listed for same assembly.
- M. Provide drain tee at appliance connection, and at the shaft before the final vertical rise.
- N. Termination
 - 1. Termination: Exit cone with drain section incorporated into riser.
- O. Basis of Design: Model Saf-T Vent CI 316 as manufactured by Heat-Fab. Vent material must be approved by the boiler or water heater manufacturer.

2.2 GUYING AND BRACING MATERIALS

- A. Cable: Galvanized, stranded wires of the following thickness:
 - 1. Minimum Size: ¼" in diameter.
 - 2. For ID Sizes 4" to 15": 5/16" diameter
 - 3. For ID Sizes 18" to 24": 3/8" diameter
 - 4. For ID Sizes 27" to 30": 7/16" diameter

5. For ID Sizes 33"to 36": ½" diameter
 6. For ID Sizes 39" to 48": 9/16" diameter
 7. For ID Sizes 51" to 60": 5/8" diameter
- B. Pipe: Galvanized steel, NPS 1¼"
- C. Angle Iron: Galvanized steel, 2" by 2" by ¼"

PART 3 - EXECUTION

3.1 EXAMINATION

- A. Examine areas and conditions for compliance with requirements for installation tolerances and other conditions affecting performance of work. Proceed with installation only after unsatisfactory conditions have been corrected.

3.2 APPLICATION

- A. Listed Special Gas Vent: Condensing gas appliances.

3.3 INSTALLATION

- A. Install in accordance with manufacturer's instructions and UL.
- B. Install in accordance with recommendations of ASHRAE - Handbook, Equipment Volume, Chapter "Chimney, Gas, Vent and Fireplace Systems" and ANSI Z223.1 (NFPA 54).
- C. Listed Vents and Chimneys
1. The prefabricated flue system shall be installed according to the manufacturer's installation instructions and shall conform to all applicable state and local codes.
 2. Provide all modular straight sections, fittings, supports, guides, expansion joints, guy sections, guy tensioners, roof thimbles, roof flashings, storm collars and stack cap terminations as required to provide a complete system per the manufacturer's installation instructions.
 3. Locate to comply with minimum clearances from combustibles and minimum termination heights according to product listing or NFPA 211, whichever is most stringent.
 4. Seal between sections of positive-pressure vents according to manufacturer's written installation instructions, using sealants recommended by manufacturer.
 5. The vent system shall be designed to compensate for all flue gas induced thermal expansion.
 6. Support vents at intervals recommended by manufacturer to support weight of vents and all accessories, without exceeding appliance loading.
 7. Slope breechings down in direction of appliance, with condensate drain connection at lowest point piped to nearest drain.
 8. Lap joints in direction of flow.
 9. Connect base section to foundation using anchor lugs of size and number recommended by manufacturer.
 10. Join sections with acid-resistant joint cement to provide continuous joint and smooth interior finish.

11. Roof penetrations shall be suitable for the specified roof construction and shall comply with the manufacturer's installation instructions.
12. Erect stacks plumb to finished tolerance of no more than 1" out of plumb from top to bottom.

D. Cleaning

1. After completing system installation, including outlet fittings and devices, inspect exposed finish. Remove burrs, dirt, and construction debris and repair damaged finishes.
2. Clean breechings internally, during and after installation, to remove dust and debris. Clean external surfaces to remove welding slag and mill film. Grind welds smooth and apply touchup finish to match factory or shop finish.
3. Provide temporary closures at ends of breechings, chimneys, and stacks that are not completed or connected to equipment.

3.4 TESTING

- A. Manufacturer Installation Inspection Report - Provide report prepared by manufacturer's representative, stating that systems installed and services provided under this Section are in accordance with manufacturer's recommendations and are properly operating.

END OF SECTION

P:\22 Projects\22-1142-00coev\04 Design\07 Specs\Div 23\23 5100-Breechings, Chimneys, and Stacks.docx

SECTION 23 5216
CONDENSING HYDRONIC BOILERS

PART 1 - GENERAL

1.1 SCOPE OF WORK

- A. Products provided in this section include:
 - 1. Gas-Fired fire tube condensing hot water boilers
 - 2. Boiler trim and accessories

1.2 DEFINITIONS

- A. SCAQMD: South Coast Air Quality Management District
- B. TCEQ: Texas Commission on Environmental Quality

1.3 CODES AND STANDARDS (UTILIZE LATEST EDITION)

- A. American Boiler Manufacturers Association (ABMA)
 - 1. Packaged Fire Tube Ratings.
- B. American National Standards Institute (ANSI)
 - 1. ANSI/AGA Z21.13: Gas Fired Low Pressure Steam and Hot Water Boilers
 - 2. ANSI/AGA Z223.1: National Fuel Gas Code
- C. Air-Conditioning, Heating & Refrigeration Institute (AHRI)
 - 1. AHRI BTS-2000: Method to Determine Efficiency of Commercial Space Heating Boilers.
- D. American Society of Heating, Refrigerating and Air-Conditioning Engineers (ASHRAE)
 - 1. ASHRAE 90.1: Energy Standard for Buildings except Low-Rise Residential Buildings
- E. ASME International (ASME)
 - 1. ASME B1.20.1: Pipe Threads, General Purpose, Inch
 - 2. ASME B16.5: Pipe Flanges and Flanged Fittings
 - 3. ASME B16.24: Cast Copper Alloy Pipe Flanges, Class 150, 300, 400, 600, 900, 1500, and 2500, and Flanged Fittings, Class 150 and 300
 - 4. ASME B31.1: Power Piping
 - 5. ASME B31.9: Building Services Piping
 - 6. ASME CSD-1: Controls and Safety Devices for Automatically Fired Boilers.
 - 7. ASME SEC 1 Boiler and Pressure Vessels Code Rules for Construction of Power Boilers.
 - 8. ASME SEC 4: Boiler and Pressure Vessels Code Rules for Construction of Heating Boilers.
 - 9. ANSI/ASME SEC 8D: Boilers and Pressure Vessels Code -Rules for Construction of Pressure Vessels.

- F. ASTM International (ASTM)
 - 1. ASTM A 959: Guide for Specifying Harmonized Standard Grade Compositions for Wrought Stainless Steels
- G. FM - Factory Mutual.
- H. Hydronics Institute (HI)
 - 1. Testing and Rating Standard for Cast Iron and Steel Heating Boilers
 - 2. Testing Standard for Commercial Boilers
- I. National Electrical Manufacturers Association (NEMA)
 - 1. NEMA 250: Enclosures for Electrical Equipment (1000 Volts Maximum)
 - 2. NEMA FU 1: Low Voltage Cartridge Fuses
- J. National Fire Protection Association (NFPA)
 - 1. NFPA 54: National Fuel Gas Code.
 - 2. NFPA 70: National Electrical Code.
- K. Underwriters Laboratories (UL®).
 - 1. UL 795: Standard for Commercial-Industrial Gas Heating Equipment.
 - 2. UL 1738: Standard for Venting Systems for Gas-Burning Appliances.
- L. XL GAPS - Global Asset Protection Services (GAPS) Guidelines.

1.4 QUALITY ASSURANCE

- A. Electrical Components, Devices and Accessories: Listed and labeled as defined in NFPA 70, Article 100, by a testing agency acceptable to authorities having jurisdiction, and marked for intended use.
- B. ASME Compliance: Fabricate and label boilers to comply with ASME Boiler and Pressure Vessel Code, Section IV "Heating Boilers", for a maximum allowable working pressure of 160 PSIG.
- C. CSD-1 Compliance: The boiler shall comply with ASME Controls and Safety Devices for Automatically Fired Boilers (CSD-1).
- D. ASHRAE/IESNA 90.1 Compliance: Boilers shall have minimum efficiency according to "Gas and Oil Fired Boilers - Minimum Efficiency Requirements."
- E. UL Compliance: Boilers must be tested for compliance with UL 795, "Commercial-Industrial Gas Heating Equipment." Boilers shall be listed and labeled by ETL.
- F. AHRI Compliance: Boilers shall be tested and rated according to the BTS-2000 test standard and verified by AHRI.
- G. NOx Emissions Compliance: Boiler shall be tested for compliance with SCAQMD and TCEQ.
- H. Test and inspect factory-assembled boilers, before shipping, according to ASME Boiler and Pressure Vessel Code.
- I. Each boiler shall be installed and operated in a functioning hydronic system, inclusive of venting, as part of the manufacturing process. A factory test fire report corresponding to the boiler configuration shall be included with each boiler.

1.5 SUBMITTALS

- A. Preconstruction – Prior to construction provide the following in accordance with Specification 20 0500 – Basic Requirements for Mechanical, Plumbing, and Fire Suppression:
1. Product Data:
 - a. Include technical product data of selected model, construction details, material descriptions, dimensions of individual components and profiles, weights (shipping, installed and operating), installation and start-up instructions, and furnished accessory information.
 - b. Include performance data, rated capacities, operating characteristics, and furnished specialties and accessories.
 2. Shop Drawings: For boiler, standard boiler trim and accessories.
 - a. End Assembly Drawing: Detail overall dimensions, connection sizes, connection locations, and clearance requirements.
 - b. Wiring Diagrams: Detail electrical requirements for the boiler including ladder type wiring diagrams for power, interlock and control wiring. Clearly differentiate between portions of wiring that are factory installed and portions to be field installed.
 3. Shop Drawings: For master boiler control panel and accessories.
 - a. Controls Schematic Drawings: Detailed drawings showing configurations of all components and devices.
 - b. Sequence of Operation: Complete sequence of operation including all alarms and failure modes.
 - c. List of communication points and addresses available for remote monitoring via BACnet.
 - d. Wiring Diagrams: Detail electrical requirements for the master control panel including diagrams for power, interlock and control wiring. Clearly differentiate between portions of wiring that are factory installed and portions to be field installed.
 4. Certificate of Product Rating: Submit AHRI Certificate indicating Thermal Efficiency, Combustion Efficiency, Materials of Construction, Input, and Gross Output conform to the design basis.
 5. Thermal efficiency curves: Submit thermal efficiency curves for a minimum of five (5) input rates between and including minimum and maximum rated capacities, for return water temperatures ranging from 80°F to 180°F.
 6. Water side pressure drop curve.
 - a. Indicate minimum required water flow rate.
 7. Flue gas temperature curves: Submit flue gas temperature curves for minimum and maximum boiler capacity, for return water temperatures ranging from 80°F to 160°F.
 8. ASME Stamp Certification and Report: ASME Stamp Certification and Form H-2 Manufacturer's Data Report, as required by authorities having jurisdiction, and document hydrostatic testing of piping external to boiler.
 9. Source quality-control test reports.
- B. Contract Closeout – At contract closeout provide the following in accordance with Specification 20 0500 – Basic Requirements for Mechanical, Plumbing, and Fire Suppression:
1. Operation and Maintenance Data: Data to be included in Installation and Operation Manual.

2. Field quality-control test reports: Start-up by a factory authorized factory representative.
3. Boiler water chemistry requirements for use by Owner and water treatment supplier.
4. Warranties

1.6 DELIVERY, STORAGE AND HANDLING

- A. Deliver products to site. Store and protect boilers from damage by leaving factory inspection openings and shipping packaging in place until final installation.
- B. Units shall be shipped factory assembled with all internal and external components, controls and appurtenances.
- C. Installing contractor to rig, unload and transport boilers to final location as approved and supervised by manufacturer's representative.

1.7 SPARE PARTS

- A. Not used

1.8 WARRANTY

- A. Standard Warranty: Manufacturer's standard form in which manufacturer agrees to repair or replace components of boilers that fail in materials or workmanship within specified warranty period.
 1. Warranty period for the entire boiler: The boiler manufacturer will repair or replace any part of the boiler that is found to be defective in workmanship or material within eighteen (18) months of shipment from the factory or twelve (12) months from start-up, whichever comes first.
 2. Extended warranty period for the pressure vessel and heat exchanger: The boiler manufacturer shall warranty against failure due to thermal shock for a period of ten (10) years and failure due to flue gas condensate corrosion for a period of ten (10) years, non-prorated, from the date of shipment from the factory provided that the boiler is installed, controlled, operated and maintained in accordance with the Installation, Operation and Maintenance Manual.

1.9 MAINTENANCE

- A. Not used

PART 2 - PRODUCTS

2.1 FIRE TUBE CONDENSING BOILERS

- A. Basis of Design Manufacturer
 1. Fulton ENDURA+ (EDR+) 4000 (basis of design)
- B. Description: Factory-fabricated, -assembled, and -pressure tested, fire tube condensing boiler with heat exchanger sealed pressure tight, built on a steel base; including flue gas vent; combustion air intake connections, water supply, water return, condensate drain, and controls.
- C. The boiler, burner and controls shall be completely factory assembled as a self-contained unit. Each boiler shall be neatly finished, thoroughly tested, and properly packaged for shipping.
- D. Heat Exchanger: The heat exchanger is defined as the surfaces of the pressure vessel where flue gases transfer sensible and latent heat to the hydronic fluid.
 1. The boiler shall be a fire tube design.

2. Material: The heat exchanger shall constructed of duplex alloys of stainless steel.
 - a. Boilers with heat exchangers constructed of cast aluminum, mild steel, cast iron or copper finned tube materials are not acceptable.
 3. Furnace: First pass of the combustion chamber shall be constructed of duplex alloy stainless steel with a minimum wall thickness of 0.25" and a minimum bottom head thickness of 0.625".
 4. Furnace to tube connections shall be constructed with low weld intensity, a tube to tube minimum spacing of 2" center to center, minimum 5/8" tube to tube ligament, and shall not contain any overlapping welds.
 5. Fire tubes: Second and third passes of the combustion chamber shall be constructed of duplex alloys of stainless steel having a minimum wall thickness of 0.109".
 6. Heat exchange capability shall be maximized within the heat exchanger via the use of corrugated fire tube technology. The corrugation process shall not remove any material from the tubes. Aluminum heat transfer enhancements are dissimilar metals and are unacceptable.
- E. Pressure Vessel: Design and construction shall be in accordance with Section IV of the ASME Code for heating boilers.
1. The shell shall be minimum 0.3125" thick steel.
 2. The top head shall be a minimum 0.375" thick steel.
 3. The water side of the pressure vessel shall be a counter-flow design with internal water-baffling plates.
 4. The boiler return and supply water connections shall be:
 - a. Sizes 2" and under: Threaded male NPT
 - b. Sizes over 2": 150# ANSI flanged.
- F. Burner: Natural gas, forced draft.
1. Burner Head: Shall be a woven fiber premix design.
 2. Excess Air: The burner shall operate at no greater than 7.0% excess O₂ over the entire turndown range.
 3. Emissions: When operating on natural gas, the boiler shall maintain a NO_x level of <20 ppm, and CO emissions less than 50 ppm, over the complete combustion range at a 3% O₂ correction.
 4. Full Modulation Turndown: 5:1
- G. Blower: Variable speed, non-sparking, hardened aluminum impeller centrifugal fan.
1. Motor: Brushless DC variable speed motor with sensor feedback; internal electronic controller with built in speed control and safeties; sealed ball bearing with high temperature grease.
 2. Variable speed blower: PWM signal input with tachometer output.
- H. Main Fuel Train:
1. The boiler shall have a pre-mix combustion system, capable of operating at a minimum 4" w.c. incoming natural gas pressure while simultaneously achieving emissions performance, full modulation, and full rated input capacity. Maximum natural gas pressure allowed to the inlet of the fuel train shall be no less than 28" w.c.

2. A factory mounted main fuel train shall be supplied. The fuel train shall be fully assembled complete with high and low gas pressure switches, wired, and installed on the boiler and shall comply with CSD-1 code. The fuel train components shall be enclosed within the boiler cabinet.
 3. A lock up regulator upstream of the fuel train shall be furnished by the boiler manufacturer as a standard component integral to the boiler cabinet. Factory test fire of the boiler with the provided lock up regulator is required.
 4. Standard CSD-1 fuel train shall comply with the XL GAPS Guidelines.
- I. Ignition: Direct spark ignition with transformer. A UV scanner shall be utilized to ensure precise communication of flame status back to the flame programmer.
- J. Boiler Enclosure:
1. Sealed Cabinet: Jacketed steel enclosure with left hinged full height front access door, fully removable latching access panels, gasketed seams to maintain sealed combustion, mounted on a steel skid with steel plate decking.
 2. Cabinet shall be insulated such that external convection and radiation heat losses to the boiler room from the boiler shall comply with ASHRAE 103, and shall not exceed 0.2% of the rated boiler input at maximum capacity.
 3. Control Enclosure: NEMA 250, Type 1.
 4. Finish: Internally and externally primed and painted finish.
 5. Combustion Air: Drawn from the inside of the sealed cabinet, preheating the combustion air.
 6. Rigging and Placement: The boiler shall include lifting lugs and fork hole accessibility for rigging.
- K. Exhaust Manifold: Shall be constructed of stainless steel with provisions to collect and dispose flue gas condensate. The exhaust outlet connection shall allow for immediate vertical rise off the boiler without requiring an elbow or tee.
- L. Performance Criteria:
1. Heating Medium: Capacities shall be based on 100% water.
 2. Design Water Pressure Rating: 160 psig.
 3. Safety Relief Valve Setting: 125 psig.
 4. Minimum Return Water Temperature: No minimum temperature required.
 5. Maximum Allowable Water Temperature: 210°F.
 6. Minimum Water Flow Rate: No minimum flow rate required to protect the heat exchanger.
 7. Minimum Side Clearance: 1" between boilers.
- M. The boiler efficiency shall be tested and certified per the AHRI for natural gas operation. The test parameters for efficiency certification shall be based on the BTS-2000 standard. The certified thermal efficiency for natural gas firing shall not be less than 90%.
- N. A zero flow or low flow condition shall not cause any harm to the pressure vessel or heat exchanger of the boiler. Flow switches, dedicated circulator pumps, or primary-secondary arrangements shall not be required to protect the boiler from thermal shock. Boilers requiring the use of flow switches or primary-secondary piping arrangements are not acceptable.

2.2 TRIM

- A. Safety Relief Valve: ASME Rated. Provided by the manufacturer.
- B. Boiler air vent
- C. Drain valve: Hose-end ball valve
- D. Combustion Air Inlet Filter: 50 Micron. Provided by the manufacturer.
- E. Flue Gas Condensate Drain Trap: A flue gas condensate drain trap shall be provided by the manufacturer to prevent positive pressure exhaust gases from entering the boiler room.
- F. Flue Gas Condensate Neutralization Kit:
 - 1. Provide one (1) flue gas condensate neutralization tank per boiler.
 - 2. The tank shall include threaded inlet, outlet and vent. The tank shall have seamless construction and be manufactured from high density Polyethylene "HDPE". The top shall have a bolt down cover with gasket for inspection and replenishment of neutralizing media.
 - 3. Unit will include an initial charge of neutralizing media.

2.3 CONTROLS

- A. Each boiler shall be provided with all necessary controls, all necessary programming sequences, and all safety interlocks. Each boiler control system shall be interlocked with all safeties.
- B. Each boiler shall be provided with a "Full Modulating" firing control system whereby the firing rate is infinitely proportional at any firing rate between low fire and high fire as determined by the pulse width modulation input control signal. Both fuel input and air input must be sequenced in unison to the appropriate firing rate without the use of mechanical linkage.
- C. Each boiler electrical control panel shall include the following devices and features:
 - 1. Color touch screen control display factory mounted on the front cabinet panel door.
 - 2. The control display shall serve as a user interface for programming parameters, boiler control and monitoring; and shall feature a screen saver, screen disable for cleaning, contrast control, volume control for alarm features, boiler status, configuration, history and diagnostics.
 - 3. The boiler control panel shall be constructed in a UL 508 approved panel.
 - 4. 24 VAC control transformer
 - 5. Control relay for motorized isolation valve control
 - 6. The flame safeguard control on the boiler shall be integrated with temperature control and lead/lag sequencing modular boiler plant functionality.
 - 7. Control with Factory Installed Jumper: Safety Interlock for External Device, Remote Boiler Enable, Remote Lead/Lag Enable and Emergency Stop (E-Stop)
 - 8. Provide a unit mounted Hand-Off-Auto (HOA) switch.
 - 9. All controls are to be cabinet, vessel or panel mounted and so located on the boiler as to provide ease of servicing the boiler without disturbing the controls. All controls shall be mounted and wired according to UL requirements.

- D. Burner Operating Controls: Factory mounted and wired burner safety controls limit burner operation:
1. High Limit Temperature Sensor with Manual Reset: A CSD-1 CW-400 complaint UL 353 high limit temperature sensor shall turn off the burner when water temperature reaches or exceeds the high limit.
 - a. Manual reset stops the burner if operating conditions rise above maximum boiler design temperature.
 2. Low-Water Cut Off: Electronic probe type mounted in the pressure vessel shall prevent burner operation on low water alarm.
 3. Air Safety Switch: Prevent operation unless sufficient combustion air is proven.
 4. High Condensate Probe: Prevent operation in the event of a blocked condensate drain.
 5. Blocked Exhaust: Prevent operation in the event of a blocked flue gas exhaust stack.
- E. Integral Sequencing Control of Modular Boiler Plants: Sequencing capabilities (lead/lag) shall be integral to the boiler controller for up to two (2) boilers installed in the same hydronic loop and shall not require an external panel.
1. The boiler manufacturer shall provide a supply water header temperature sensor. The sensor shall be NTC resistive 10KOhm $\pm 1\%$ at 77°F, field installed in the common supply water piping, and field wired to the master boiler.
 2. One (1) boiler in the system shall be field programmed as the master and subsequent boilers will be programmed as lag units.
 3. Provide two (2) options to set the hot water supply temperature setpoint.
 - a. Provide an outside air temperature sensor for the Boiler Control Panel to linearly reset the hot water supply temperature setpoint based on outside air temperature.
 - b. Remote hot water supply temperature setpoint signal (analog input signal). Boiler Control Panel to accept a 4-20 mA signal from the BAS to set the hot water supply temperature setpoint.
 4. Sequence of Operation:
 - a. Upon call for heat and demand in the system, a boiler will be enabled at low fire and will modulate according to demand and PID settings up to the base load common value. The "base load common value" shall be field adjustable with an initial setting of 30%. The final setting will be determined by the boiler manufacturer's technician during start-up
 - b. If the heating load exceeds the output at the base load common firing rate, the next boiler in the sequence will be enabled at low fire. Modular boilers will modulate up and down in parallel as a cohesive unit with infinite modulation points to meet heating load requirements.
 - c. This process continues until all available boilers are enabled, at which point they are released to modulate up to full fire if required.
 - d. As the load decreases, the boilers will be sequentially disabled.
 - e. Boiler sequence order shall be rotated on a programmable number of run hours.
 - f. A boiler in lockout alarm shall be automatically removed from the sequence order.
 - g. Lag boilers shall default to local control if the master boiler is fully powered off or removed.

- h. Each individual boiler shall enable and disable a water circulation control device. The enable of the device, for example a motorized isolation valve or boiler circulator, will be simultaneous with the heat demand for that boiler. The disable of each device will be based on a programmable time delay when the heat demand is no longer present. In variable primary arrangements, the control shall hold the lead boiler isolation valve open at all times.

2.4 POWER SUPPLY

- A. Single-Point Field Power Connection: Factory-installed and factory-wired switches, transformers, control and safety devices and other devices shall provide a single-point field power connection to each boiler.
 - 1. House in NEMA 250, Type 1 enclosure.
 - 2. Wiring shall be numbered and color coded to match wiring diagram.
 - 3. Install factory wiring outside of an enclosure in a metal raceway.
 - 4. Field power interface shall be to wire lugs in a factory installed connection box on the boiler.
- B. Electrical Characteristics: 460 V/3 phase/60 Hz

2.5 VENTING

- A. The boiler shall be capable of operating with a stack effect not exceeding -0.04" w.c. and a combined air intake and exhaust venting pressure drop not exceeding +1.50" w.c.
- B. Each boiler shall have a separate vent, no combining of vent exhaust permitted.
- C. Flue Gas Exhaust: The flue gas exhaust stack shall be listed and labeled to UL-1738 / C-UL S636 for use with Category II/IV appliances, guaranteed appropriate for the application by the manufacturer and supplier of the venting. Refer to Section 23 5100 "Breechings, Chimneys, and Stacks" for additional information.
- D. Combustion Air Intake: Combustion air shall be drawn from the mechanical room. Provide adequate air supply to the room in accordance with all codes and standards.

PART 3 - EXECUTION

3.1 INSTALLATION

- A. Examination
 - 1. Before boiler installation, examine rough-in for concrete equipment bases, anchor-bolt sizes and locations, and piping and electrical connections to verify actual locations, sizes, and other conditions affecting boiler performance, maintenance, and operations.
 - 2. Boiler locations indicated on Drawings are approximate. Determine exact locations before roughing-in for piping and electrical connections.
 - 3. Examine mechanical spaces for suitable conditions where boilers will be installed.
 - 4. Proceed with installation only after satisfactory conditions have been verified.
- B. Install boilers level on concrete housekeeping pad.
- C. Install gas-fired boilers according to NFPA 54.

- D. Equipment and materials shall be installed in an approved manner and in accordance with the boiler manufacturer's installation requirements.
- E. Assemble and install boiler trim.
- F. Install devices furnished with the boiler but not factory mounted.
- G. Install control wiring to field-mounted devices.
- H. Piping Connections
 - 1. Piping installation requirements are specified in other Division 23 Sections. Drawings indicate general arrangement of piping, fittings, and specialties.
 - 2. Install piping adjacent to boiler to allow for service and maintenance.
 - 3. Install piping from flue gas condensate drain traps to the neutralizing tanks.
 - 4. Install piping from equipment drain connections to the neutralizing tanks and from neutralizing tanks to the nearest floor drain. Piping shall be at least full size of connection. Condensate drain piping shall be **stainless steel**. Copper, carbon steel, CPVC, or PVC pipe materials are not acceptable.
 - 5. Connect gas piping to boiler gas train inlet with isolation valve and union. Piping shall be at least full size of gas train connection. Provide reducer if required.
 - 6. Connect hot water supply and return water connections with pressure gauges, thermometers, shutoff valves and low point drain valves at each connection.
 - 7. Install piping from safety relief valves to the nearest floor drain.
- I. Boiler Venting:
 - 1. Install flue venting and combustion air-intake.
 - 2. Connect to boiler connections, flue size and type in accordance to Section 23 5100 "Breechings, Chimneys, and Stacks".
- J. Controls:
 - 1. Coordinate with the Temperature Controls contractor regarding installation of shipped loose and field installed control devices, wiring of boiler control panels and devices, and integration of the master boiler control panel with the BAS.
- K. Connect power wiring according to electrical specifications.
- L. Ground equipment according to electrical specifications.
- M. Provide emergency power off switch for remote boiler shutdown at entrance to boiler room. Emergency switch shall cut power/fuel to all boilers when activated. Coordinate with Electrical Contractor.

3.2 MANUFACTURER'S FIELD SERVICES

- A. Manufacturer shall provide a factory representative to provide the following services:
 - 1. Prior to equipment start-up, inspect each boiler verifying that installation is accordance with the manufacturer's recommendations.
 - 2. Leak Test: Hydrostatic test. Repair leaks and retest until no leaks exist.

3. Operational test:
 - a. Perform start-up operation of each boiler to assure proper functioning of equipment per manufacturer's written instructions.
 - b. Adjust air-fuel ration and combustion.
 - c. Check and adjust initial operating set points and high- and low-limit safety set points of fuel supply, water level and water temperature.
 - d. Set field-adjustable switches and circuit-breaker trip ranges as indicated.
 - e. Perform field tests to determine capacity and efficiency of burners. Test at full capacity, at low fire and at points between high and low fire.
 4. Complete programming of boiler control panel per specified sequence of operation. All necessary adjustments will be made to place the boilers in operating condition.
 5. Coordinate with the Temperature Controls Contractor regarding remote boiler plant enable/disable command, boiler isolation valve interlocks and monitoring of boiler operating parameters.
 6. Remove and replace any malfunctioning devices and retest as specified above.
 7. Occupancy Adjustments: Within twelve (12) months of the boiler start-up, provide onsite assistance in adjusting system to suit actual occupied conditions. Provide up to two (2) visits to the job site during normal occupancy hours for this purpose.
- B. Training: After successful completion of boiler start-up, a factory trained representative shall instruct and supervise the Owner's operation & maintenance personnel in approved operating and maintenance procedures. These procedures include, but are not limited to:
1. Operating and maintenance procedures shall include a minimum of four (4) hours of onsite training during regular working hours.
 2. Onsite training on operating procedures shall include, but are not limited to:
 - a. Pre-start system verification.
 - b. Start-up.
 - c. Steady-state operation.
 - d. Normal and emergency shutdown.
 - e. Manual operation of boilers upon failure of the BAS.
 3. Onsite training on maintenance procedures shall include, but are not limited to:
 - a. Routine and normal.
 - b. Guide to "trouble-shooting".
 - c. Servicing schedule.
- C. Field Inspection and Report:
1. Provide a written report, in accordance with Conditions of Contract, prepared by manufacturer's representative, stating that systems installed and services provided under this Section are in accordance with manufacturer's recommendations and are properly operating. Include results of tests and inspections in the report.

3.3 TESTING, ADJUSTING AND BALANCING

- A. Comply with the requirements of specification Section 23 0593 "Testing, Adjusting, and Balancing for HVAC" for hydronic system testing, adjusting, and balancing.

3.4 CLEANING

- A. After completing system installation and testing, adjusting, and balancing the boilers and water distribution systems, and start-up services, clean the boiler room to remove construction dirt and dust.

END OF SECTION

P:\22 Projects\22-1142-00coev\04 Design\07 Specs\Div 23\23 5216 Condensing Hydronic Boilers.docx



Grumman/Butkus Associates
Energy Efficiency Consultants and Sustainable Design Engineers

820 Davis St. Ste 300
Evanston, Illinois 60201 4446
847.328.3555 grummanbutkus.com

CONSULTANTS

SCALE

EVANSTON PUBLIC LIBRARY BOILER REPLACEMENT BID 23-07

SITE PLAN

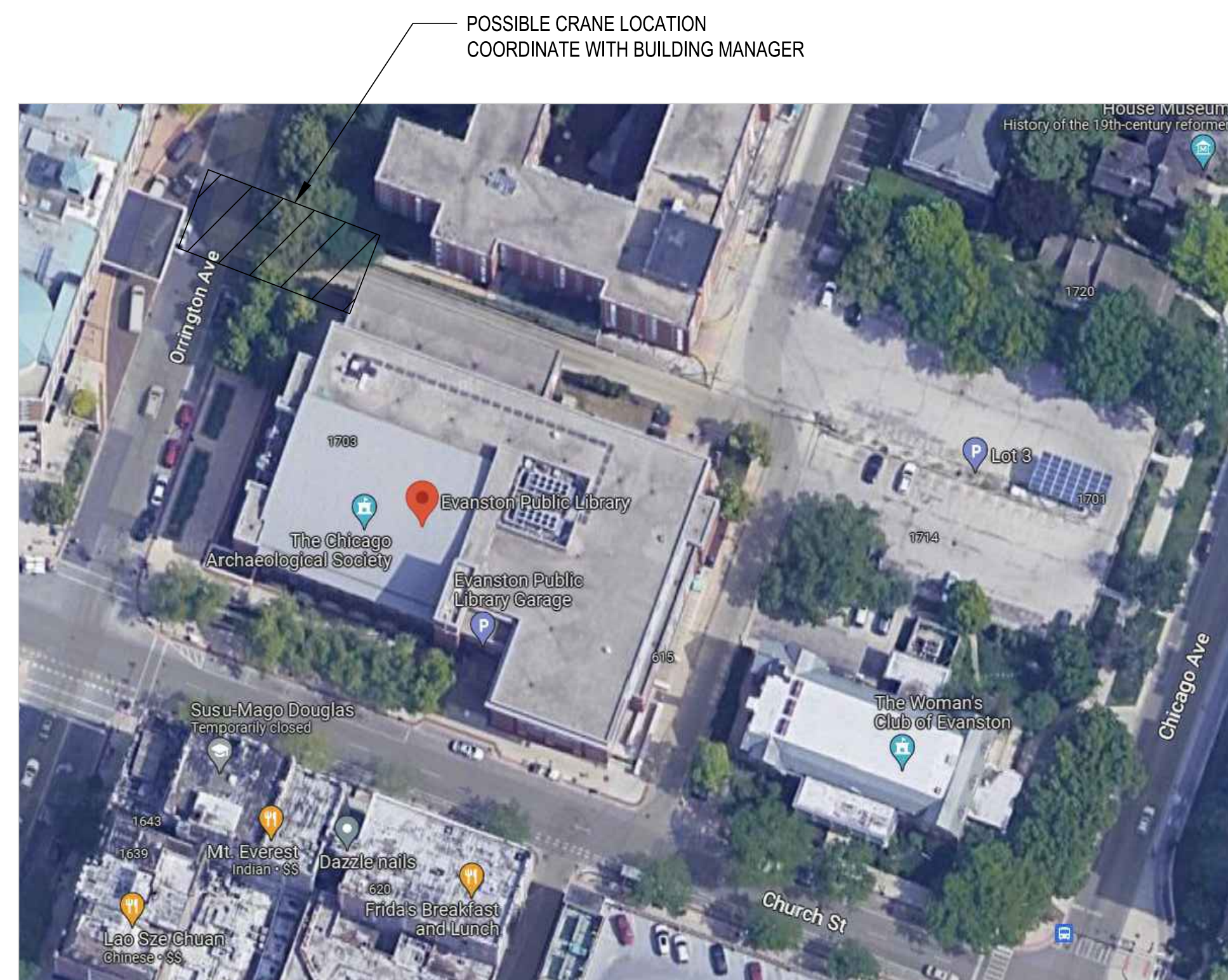

DRAWING INDEX

CS	COVER SHEET
M001	MECHANICAL SYMBOLS, ABBREVIATIONS, AND SCHEDULES
MD100	4TH FLOOR MECHANICAL PLAN - DEMOLITION
M100	4TH FLOOR MECHANICAL PLAN - NEW WORK
M200	FLOW DIAGRAMS - DEMOLITION AND NEW WORK
M300	MECHANICAL DETAILS
M400	TEMPERATURE CONTROLS SYMBOLS AND NOTES
M401	TEMPERATURE CONTROLS
E001	ELECTRICAL SPECIFICATIONS, NOTES, ABBREVIATIONS, AND SYMBOLS
E002	ELECTRICAL SCHEDULES AND DETAILS
ED100	ELECTRICAL PLAN - DEMOLITION
E100	ELECTRICAL PLAN - NEW WORK

GENERAL NOTES

- EVANSTON LIBRARY POINT OF CONTACT:
JOHN DEVANEY, MANAGER.
JDEVANEY@CITYOFEVANSTON.ORG.
847.448.8622
- FACILITY OPERATING HOURS:
SUNDAY 12 PM - 6 PM
MONDAY-THURSDAY 10 AM - 8 PM
FRIDAY-SATURDAY 9 AM - 6 PM
- THE MECHANICAL CONTRACTOR SHALL BE THE PRIME CONTRACTOR FOR THE PROJECT. THE MECHANICAL CONTRACTOR SHALL INCLUDE ALL COSTS ASSOCIATED WITH THE WORK OF SUBCONTRACTORS AND THE COORDINATION AND ADMINISTRATION OF THAT WORK IN THE BID SUBMITTED.
- TEMPERATURE CONTROLS WORK SHALL BE A SUBCONTRACT TO THE PRIME CONTRACTOR. SIEMENS BUILDING TECHNOLOGIES SHALL BE THE TEMPERATURE CONTROLS CONTRACTOR. CONTACT ERIC GREUBEL. ERIC.GREUBEL@SIEMENS.COM
- RELOCATE ANY DUCT, SPRINKLER, FIRE ALARM DEVICE, LIGHT, CONDUIT, PIPE, SWITCH, VENT, WIRE, ETC. REQUIRED FOR DEMOLITION OR INSTALLATION OF NEW WORK.
- PROVIDE TESTING, ADJUSTING AND BALANCING OF WATER AND AIR FLOWS AS SPECIFIED.
- PROVIDE EQUIPMENT AND SYSTEM STARTUP AND TESTING. BOILER VENDOR SHALL VISIT THE SITE AND PROVIDE DOCUMENTATION REPORT PER 01 7700.
- PROVIDE WARRANTY, O&M MANUALS, RECORD AS-BUILT DRAWINGS AND ALL OTHER SPECIFIED CLOSEOUT DOCUMENTATION PER 01 7700.
- REMOVE EVERYTHING FROM THE JOB SITE MADE OBSOLETE OR NOT NEEDED BY THIS WORK.
- FOR BUILDING SYSTEM EMERGENCIES, CONTACT BUILDING MANAGER.
- THE CITY OF EVANSTON WILL PULL/PAY FOR PERMITS. THE CONTRACTOR(S) WILL PROVIDE ALL OTHER USUAL ITEMS.

PROJECT CODES

EVANSTON BUILDING CODES:
2021 INTERNATIONAL BUILDING CODE WITH AMENDMENTS
2020 NFPA NATIONAL ELECTRICAL CODE WITH AMENDMENTS
2021 INTERNATIONAL MECHANICAL CODE WITH AMENDMENTS
2021 INTERNATIONAL FUEL GAS CODE WITH AMENDMENTS
2021 INTERNATIONAL FIRE CODE WITH AMENDMENTS
2021 NFPA LIFE SAFETY CODE 101 WITH AMENDMENTS
2014 STATE OF ILLINOIS PLUMBING CODE WITH AMENDMENTS
2018 ILLINOIS ACCESSIBILITY CODE WITH AMENDMENTS
2018 INTERNATIONAL ENERGY CONSERVATION CODE WITH AMENDMENTS & STATE OF ILLINOIS AMENDMENTS

PROJECT NOTES

- THE INTENT OF THE PROJECT IS TO REPLACE THE BOILERS DURING THE COOLING SEASON WHEN THEY WILL NOT BE NEEDED. ESTIMATED AVAILABLE DATES ARE AFTER MAY 1ST AND BEFORE SEPTEMBER 4TH. COORDINATE CONSTRUCTION DATES WITH BUILDING MANAGER.
- CONSTRUCTION WILL REQUIRE WORK DURING NORMAL BUSINESS HOURS, AND OUTSIDE OF NORMAL BUSINESS HOURS. CONTRACTOR TO INCLUDE FEE FOR UP TO 240 MAN-HOURS OF NIGHT AND WEEKEND WORK. ALL OTHER WORK SHALL OCCUR DURING NORMAL BUSINESS HOURS. COORDINATE SHUTDOWNS WITH BUILDING MANAGER.
- CONSTRUCTION SITE SHALL BE SWEEPED CLEAN AFTER EACH DAY OF CONSTRUCTION.
- CONTRACTOR SHALL STAGE ANCILLARY EQUIPMENT AS REQUIRED TO MEET THE INTENDED PROJECT TIMELINE.
- IT IS ANTICIPATED THAT A CRANE WILL BE REQUIRED TO HOIST THE BOILERS TO THE FOURTH FLOOR BOILER MECHANICAL ROOM. CONTRACTOR TO COORDINATE WITH THE BUILDING MANAGER AND CITY OF EVANSTON AND OBTAIN ANY REQUIRED STREET CLOSURE PERMITS.
- THE FOLLOWING OUTLINES THE GENERAL PROJECT.
 - PERFORM TEST AND BALANCE OF EXISTING HOT WATER FLOW CONDITIONS. REFER TO PRE-CONSTRUCTION TEST AND BALANCE NOTES ON DRAWING MD100 FOR MEASUREMENT LOCATIONS AND FURTHER DETAIL.
 - BOILERS (B-1 & B-2) AND THEIR CIRCULATING PUMPS (P-5 & P-6) SHALL BE DEMOLISHED. EXISTING CONCRETE PADS FOR THE BOILERS AND THE HEATING SYSTEM PUMPS (P-3 & P-4) SHALL REMAIN.
 - INSTALL THE NEW BOILERS (B-1 & B-2).
 - CONNECT THE NEW BOILERS (B-1 & B-2) TO THE HOT WATER SYSTEM.
 - PROVIDE TEMPERATURE CONTROL AND TEST AND BALANCE AFTER CONSTRUCTION IS COMPLETE.

KEYPLAN

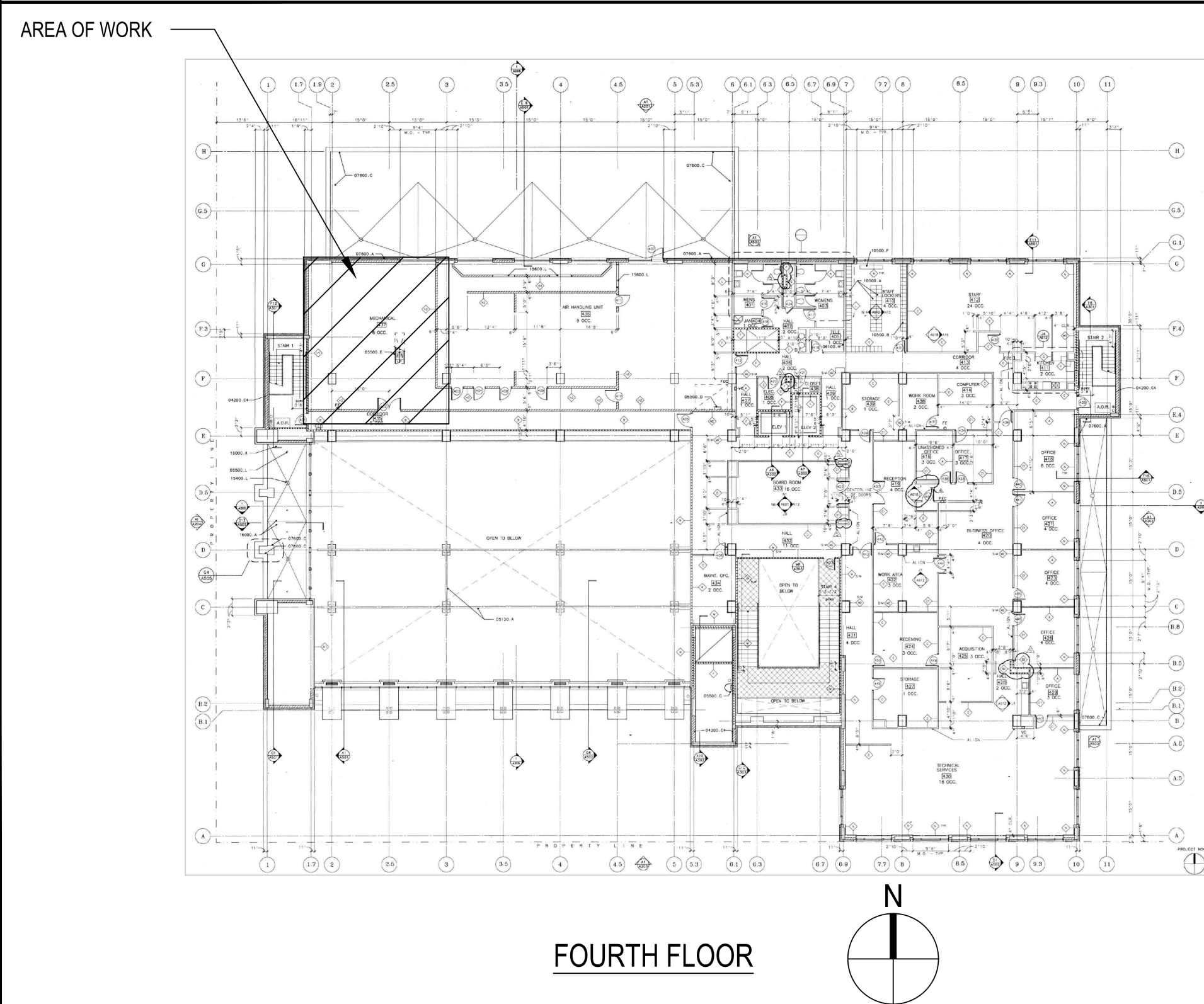

COVER SHEET
EVANSTON PUBLIC LIBRARY BOILER REPLACEMENT
1703 ORRINGTON, EVANSTON IL

ISSUES & REVISIONS		
NO.	DESCRIPTION	DATE
OWNER REVIEW		03/02/2023
ISSUED FOR BIDDING PERMIT		03/17/2023

SCALE
NO SCALE

DRAWN	CHECKED	APPROVED
ACR	ARS	JET
PROJECT NO. P22-1142-00		

CS

GENERAL	
DESIGNATION	DESCRIPTION
	DETAIL OR ENLARGED PLAN (SAME DRAWING)
	DETAIL OR ENLARGED PLAN (DIFFERENT DRAWING)
	SECTION OR ELEVATION (SAME DRAWING)
	SECTION OR ELEVATION (DIFFERENT DRAWING)
	(HEAVY LINES) - NEW PIPING/DUCTWORK/EQUIPMENT
	(THIN LINES) - EXISTING PIPING/DUCTWORK/EQUIPMENT TO REMAIN
	(HEAVY DASHED LINES) - EXISTING PIPING/DUCTWORK/EQUIPMENT TO BE DEMOLISHED
	POINT OF CONNECTION BETWEEN NEW/DEMO WORK AND EXISTING MATCH LINE

PIPEWORK FITTINGS	
DESIGNATION	DESCRIPTION
	CAP
	CONNECTION, BOTTOM
	CONNECTION, TOP
	ELBOW, 90°
	ELBOW TURNED UP
	ELBOW TURNED DOWN
	ELBOW, REDUCING (SHOW SIZES)
	ELBOW, LONG RADIUS
	ELBOW, SIDE OUTLET, OUTLET UP
	ELBOW, SIDE OUTLET, OUTLET DOWN
	LATERAL BRANCH
	REDUCER, CONCENTRIC
	INCREASER, CONCENTRIC
	REDUCER, ECCENTRIC STRAIGHT INVERT
	REDUCER, ECCENTRIC STRAIGHT CROWN
	TEE
	TEE, OUTLET UP
	TEE, OUTLET DOWN
	TEE, REDUCING (SHOW SIZES)
	TEE, SIDE OUTLET, OUTLET UP
	TEE, SIDE OUTLET, OUTLET DOWN
	UNION, SCREWED
	PITCH OF PIPE - RISE (R), DROP (D)

NOTE: ALL FITTINGS SHOWN BELOW ARE FOR USE IN SCREWED PIPING SYSTEMS UNLESS NOTED OTHERWISE. REFER TO SPECIFICATION FOR SPECIFIC PIPING SYSTEM REQUIREMENTS (SCREWED VS. FLANGED VS. WELDED VS. SOLDERED).

DUCTWORK SYMBOLS	
DESIGNATION	DESCRIPTION
	ACCESS DOOR OR PANEL, VERTICAL OR HORIZONTAL
	ACOUSTICAL LINING, DIMENSIONS SHOWN ARE CLEAR AIR PATH
	DUCT OFFSET (DOWN) IN DIRECTION OF FLOW
	DUCT OFFSET (UP) IN DIRECTION OF FLOW
	RECTANGULAR SUPPLY DUCT ELBOW TURNED DOWN
	RECTANGULAR SUPPLY DUCT ELBOW TURNED UP
	RECTANGULAR EXHAUST/RETURN DUCT ELBOW TURNED DOWN
	RECTANGULAR EXHAUST/RETURN DUCT ELBOW TURNED UP
	ROUND DUCT ELBOW TURNED DOWN
	ROUND DUCT ELBOW TURNED UP
	DIRECTION OF FLOW
	DUCT AIR PATH SIZE, FIRST FIGURE IS SIDE SHOWN
	FLEXIBLE CONNECTION
	FLEXIBLE DUCT
	DUCT SECTION, POSITIVE PRESSURE, FIRST FIGURE IS TOP
	DUCT SECTION, NEGATIVE PRESSURE, FIRST FIGURE IS TOP
	TRANSITION WITH DUCT SIZE
	RECTANGULAR ELBOWS WITH TURNING VANES
	RECTANGULAR ELBOWS WITHOUT TURNING VANES
	DUCT PENETRATION THROUGH BEAM
	CAPPED DUCT - RECTANGULAR OR ROUND
	MOTOR OPERATED DAMPER
	TRANSFER AIR DOOR GRILLE
	UNDERCUT DOOR
	LINEAR SUPPLY AIR DIFFUSER
	LINEAR RETURN AIR DIFFUSER
	CENTRIFUGAL FAN
	PROPELLER FAN
	AXIAL FAN
	VOLUME DAMPER
	SMOKE DAMPER
	FIRE DAMPER
	COMBINATION SMOKE/FIRE DAMPER

EQUIPMENT TAGS	
DESIGNATION	DESCRIPTION
AB	AIR BLENDER
AC	AIR COMPRESSOR
ADJ	ADJUSTABLE
ACC	AIR-COOLED CONDENSER
ACCU	AIR-COOLED CONDENSING UNIT
ACU	AIR CONDITIONING UNIT (AIR-COOLED OR WATER-COOLED)
AHU	AIR HANDLING UNIT
AP	MEDICAL GAS/VACUUM AREA ALARM PANEL
B	BOILER
BB	BASEBOARD RADIATION (STEAM, HOT WATER OR ELECTRIC)
CC	CHILLED WATER COOLING COIL
CCHR	CLOSED CIRCUIT HEAT REJECTOR
CH	CHILLER
CT	COOLING TOWER
CV	CONTROL VALVE
DX	DIRECT EXPANSION COOLING COIL
E	EXHAUST FAN
EC	EVAPORATIVE CONDENSER
ER	EXHAUST/RETURN FAN
FCU	FAN COIL UNIT
FIL	FILTER
HC	HEATING COIL
HP	HEAT PUMP (AIR-SOURCED OR WATER-SOURCED)
HUM	HUMIDIFIER
HK	HEAT EXCHANGER
IO	MEDICAL GAS/VACUUM INLET/OUTLET
IU	INDUCTION UNIT
KE	KITCHEN EXHAUST FAN
MU	GAS-FIRED MAKEUP AIR UNIT
P	PUMP
PH	INTAKE & EXHAUST PENTHOUSE
PRV	PRESSURE REDUCING VALVE
RCP	RADIANT CEILING HEATING/COOLING PANEL
RTU	PACKAGED ROOFTOP UNIT
S	SUPPLY FAN
SA	SOUND ATTENUATOR
SC	SHELL AND TUBE STEAM CONVERTOR
T	TANK
TD	TERMINAL DEVICE
TE	TOILET EXHAUST FAN
TU	TERMINAL UNIT
UH	UNIT HEATER
VFD	UNIT HEATER
VP	VACUUM PUMP
ZVB	MEDICAL GAS/VACUUM ZONE VALVE BOX

PIPING LEGEND	
DESIGNATION	DESCRIPTION
BBD	BOILER BLOW DOWN
BF	BOILER FEED
CF	CHEMICAL FEED
CHWR	CHILLED WATER RETURN
CHWS	CHILLED WATER SUPPLY
CA	COMPRESSED AIR
CD	CONDENSATE DRAIN ABOVE FLOOR OR GRADE (GRAVITY)
CD	CONDENSATE DRAIN BELOW FLOOR OR DRAIN (GRAVITY)
CWR	CONDENSER WATER RETURN
CWS	CONDENSER WATER SUPPLY
DCW	DOMESTIC COLD WATER
D	DRAIN
GR	GLYCOL RETURN
GS	GLYCOL SUPPLY
HPC	HIGH PRESSURE CONDENSATE
HPS	HIGH PRESSURE STEAM
HTWR	HIGH TEMPERATURE HOT WATER RETURN
HTWS	HIGH TEMPERATURE HOT WATER SUPPLY
LPC	LOW PRESSURE CONDENSATE
LPS	LOW PRESSURE STEAM
LPS(C)	LOW PRESSURE CLEAN HUMIDIFICATION STEAM
HWR	LOW TEMPERATURE HOT WATER RETURN
HWS	LOW TEMPERATURE HOT WATER SUPPLY
MU	MAKE-UP WATER
G	NATURAL GAS
O ₂	OXYGEN
PCHWR	PRIMARY CHILLED WATER RETURN
PCHWS	PRIMARY CHILLED WATER SUPPLY
PC	PUMPED CONDENSATE
ROR	REVERSE OSMOSIS RETURN
RO	REVERSE OSMOSIS SUPPLY
SCHWR	SECONDARY CHILLED WATER RETURN
SCHWS	SECONDARY CHILLED WATER SUPPLY
V	VENT TO ATMOSPHERE

ABBREVIATIONS	
DESIGNATION	DESCRIPTION
ABV	ABOVE
ACT	ACOUSTIC CEILING TILE
ADJ	ADJUSTABLE
AFF	ABOVE FINISHED FLOOR
BAS	BUILDING AUTOMATION SYSTEM
BDD	BACKDRAFT DAMPER
BHP	BRAKE HORSEPOWER
BTU	BRITISH THERMAL UNIT
CFM	CUBIC FEET PER MINUTE
CLG	CEILING
CONC	CONCRETE
CFSO	COMBINATION FIRE/SMOKE DAMPER
DB	DRY BULB
DDC	DIRECT DIGITAL CONTROL
DIA	DIAMETER
DWG	DRAWING
EL	ELEVATION
ELEC	ELECTRICAL
EQ	EQUIPMENT
EXH	EXHAUST
F OR °F	FAHRENHEIT
FD	FIRE DAMPER
FLA	FULL LOAD AMPS
FLR	FLOOR
FOB	FLAT ON BOTTOM
FOT	FLAT ON TOP
FFM	FEET PER MINUTE
FT	FEET OR FOOT
GA	GAUGE
GAL	GALLONS
GPM	GALLONS PER MINUTE
GWB	GYPSPUM WALL BOARD
HP	HORSEPOWER
HTG	HEATING
HVAC	HEATING VENTILATING AND AIR CONDITIONING
ID	INSIDE DIAMETER
KW	KILOWATT
LCP	LOCAL CONTROL PANEL
LRA	LOCK ROTOR AMPS
MAT	MIXED AIR TEMPERATURE
MAX	MAXIMUM
MCC	MOTOR CONTROL CENTER
MHP	MOTOR HORSEPOWER
MIN	MINIMUM
MCD	MOTOR OPERATED DAMPER
NC	NORMALLY CLOSED
NIC	NOT IN CONTRACT
NO	NORMALLY OPEN
NTS	NOT TO SCALE
OA	OUTDOOR AIR
OD	OUTSIDE DIAMETER
PSI(G)	POUNDS PER SQUARE INCH (GAUGE)
RH	RELATIVE HUMIDITY
RPM	REVOLUTIONS PER MINUTE
SD	SMOKE DAMPER
SO	SQUARE
TP	TOTAL PRESSURE
TYP	TYPICAL
UNO	UNLESS NOTED OTHERWISE
VAV	VARIABLE AIR VOLUME
VD	VOLUME DAMPER
VFD	VARIABLE FREQUENCY DRIVE
WB	WET BULB
WI	WITH
W/O	WITHOUT
WG	WATER GAUGE

PIPEWORK SYMBOLS	
DESIGNATION	DESCRIPTION
	PUMP
	GATE VALVE
	GLOBE VALVE
	BALL VALVE
	BUTTERFLY VALVE
	THREE WAY VALVE
	ANGLE GATE VALVE
	ANGLE GLOBE VALVE
	PLUG VALVE (GAS SERVICE)
	AUTOMATIC FLOW CONTROL VALVE
	MODULATING 2-WAY CONTROL VALVE
	MODULATING 3-WAY CONTROL VALVE
	2-WAY CONTROL VALVE (ELECTRIC OR ELECTRONIC ACTUATION)
	3-WAY CONTROL VALVE (ELECTRIC OR ELECTRONIC ACTUATION)
	SOLENOID VALVE (ELECTRIC OR ELECTRONIC ACTUATION)
	2-WAY CONTROL VALVE (PNEUMATIC ACTUATION)
	3-WAY CONTROL VALVE (PNEUMATIC ACTUATION)
	PRESSURE REDUCING VALVE
	PRESSURE RELIEF OR SAFETY VALVE
	SWING GATE CHECK VALVE
	SPRING CHECK VALVE
	STEAM TRAP (SEE SPECIFICATIONS FOR TYPE)
	HOSE END DRAIN VALVE
	Y-TYPE STRAINER (WITH BLOWOFF VALVE)
	ELECTRIC HEAT TRACE
	FLEXIBLE CONNECTOR
	DRAIN WITH BALL VALVE, HOSE END CONNECTION
	AIR VENT (AUTOMATIC)
	AIR VENT (MANUAL)
	FLOW METER, ORIFICE
	MANUAL BALANCING VALVE WITH BALL SHUT OFF VALVE
	MANUAL BALANCING VALVE WITH BUTTERFLY SHUT OFF VALVE
	THERMOMETER
	HYDRONIC PRESSURE GAUGE & NEEDLE VALVE
	STEAM PRESSURE GAUGE & NEEDLE VALVE
	UNIVERSAL PORT FOR PRESSURE GAUGE OR THERMOMETER WELL

NOTE: SYMBOLS AND ABBREVIATIONS ON THIS DRAWING ARE PART OF A GRUMMAN/BUTKUS ASSOCIATES MASTER LIST. ALL ARE NOT NECESSARILY USED ON THIS PROJECT.



Grumman/Butkus Associates
Energy Efficiency Consulting and Sustainable Design Engineers
820 Davis St, Ste 300
Evanston, Illinois 60201 4446
847.328.3555 grummanbutkus.com

CONSULTANTS

SEAL

MECHANICAL SYMBOLS, ABBREVIATIONS, AND SCHEDULES
EVANSTON PUBLIC LIBRARY BOILER REPLACEMENT
1703 ORRINGTON, EVANSTON IL

ISSUES & REVISIONS		
NO.	DESCRIPTION	DATE
OWNER REVIEW		03/02/2023
ISSUED FOR BIDDING		03/17/2023

SCALE
NO SCALE

DRAWN	CHECKED	APPROVED
ACR	ARS	JET

PROJECT NO. P22-1142-00

M001

BOILERS, HOT WATER		WATER SIDE																				NATURAL GAS BURNER				ELECTRICAL		OVERALL DIMENSIONS		SHIPPING WEIGHT		OPERATING WEIGHT		MANUFACTURER		MODEL NUMBER		REMARKS	
TAG	SERVICE	LOCATION	INPUT CAPACITY (MBH)	OUTPUT CAPACITY WITH HWRT OF 80°F (MBH) (NOTE 1)	MINIMUM EFFICIENCY WITH HWRT OF 80°F (%) (NOTE 2)	MAXIMUM WORKING PRESSURE (PSIG)	MAXIMUM WORKING TEMP (°F)	SINGLE BOILER OPERATION FLOW RATE (GPM)	PRESSURE DROP AT SINGLE BOILER OPERATION FLOW RATE (FT WG)	DUAL BOILER OPERATION FLOW RATE (GPM)	PRESSURE DROP AT DUAL BOILER OPERATION FLOW RATE (FT WG)	FLUID TYPE	MAX DESIGN LEAVING TEMP (°F)	VOLUME (GAL)	HEAT EXCHANGE SURFACE (SF)	WATER CONNECTION SIZE (IN)	GAS INLET PRESSURE RANGE (IN W.C.)	GAS HEAT CONTENT (BTU/FT ³)	FIRING AT RATED LOAD (CFH)	GAS INLET CONNECTION SIZE (IN)	COMBUSTION AIR INLET DIAMETER (IN)	FLUE OUTLET DIAMETER (IN)	MCA	VDHz	IN X H X D (IN X IN X IN)	(LBS)	(LBS)	MANUFACTURER	MODEL NUMBER	REMARKS									
B-1	HEATING HOT WATER	FOURTH FLOOR MER 437	4,000	3,784	84.6%	160	210	555	12.8	277.5	3.2	WATER	180	180	220	6	4-28	1,020	3,922	2	12	12	15	460/360	34 x 79 x 116.2	5,199	6,540	FULTON	ENDURA-4000	3.4,5,6									
B-2	HEATING HOT WATER	FOURTH FLOOR MER 437	4,000	3,784	84.6%	160	210	555	12.8	277.5	3.2	WATER	180	180	220	6	4-28	1,020	3,922	2	12	12	15	460/360	34 x 79 x 116.2	5,199	6,540	FULTON	ENDURA-4000	3.4,5									

NOTES:
1. CONDENSING BOILER OUTPUT CAPACITY IS BASED ON 80°F RETURN WATER TEMPERATURE, 20°F WATER TEMPERATURE DIFFERENTIAL AND 100% FIRING RATE.
2. CONDENSING BOILER SHALL HAVE AN AHRF EFFICIENCY RATINGS OF 83.3%.
3. FOR EACH BOILER, MINIMUM WATER FLOW RATE IS 75 GPM AND MAXIMUM IS 700 GPM.
4. PROVIDE EACH BOILER WITH INTEGRAL ENDUR-PURE CONTROL AND SMART MSTR COMMUNICATION INTERFACE.
5. PROVIDE EACH BOILER WITH PRESSURE RELIEF VALVE, LOW WATER OUT-CUT, SINGLE BOILER CONDENSATE DRAIN TRAP, pH NEUTRALIZATION KIT, AND FUEL GAS LINE PRESSURE REGULATOR.
6. PROVIDE FOR HEATING SYSTEM A SUPPLY HOT WATER HEADER TEMPERATURE SENSOR WITH THERMAL WELL AND OUTDOOR AIR TEMPERATURE SENSOR.

UNIT HEATERS, HOT WATER		HEATING COIL										SHIPPING WEIGHT		MANUFACTURER		MODEL NUMBER		REMARKS	
TAG	SERVICE	LOCATION	TYPE	FAN			AIR SIDE			FLUID SIDE			WEIGHT (LB)	MANUFACTURER	MODEL NUMBER	REMARKS			
				AIRFLOW (CFM)	SPEED (RPM)	MOTOR RATED POWER (HP)	MOTOR VOLTAGE (V)	HEATING CAPACITY (MBH)	ENTER AIR TEMP (°F)	FLOW RATE (GPM)	ENTER FLUID TEMP (°F)	MAXIMUM PRESSURE DROP (FT WG)							
UH-30	FOURTH FLOOR MER 437	FOURTH FLOOR MER 437	HORIZONTAL	1,800	1,000	1/12	120/160	67.2	60	7.9	180	0.36	49	TRANE	S-108	1			

NOTES:
1. PROVIDE LINE VOLTAGE THERMOSTAT CONTROL.

FANS		AIRFLOW				STATIC PRESSURE		DRIVE		WHEEL		FAN SPEED		DISCHARGE		ABSORBED POWER		RATED POWER		MOTOR DATA		WEIGHT		MANUFACTURER		MODEL NUMBER		REMARKS	
TAG	SERVICE	LOCATION	SYSTEM REQUIRED (CFM)	EQUIPMENT CAPACITY (CFM)	(IN WG)	(IN WG)	(BELT OR DIRECT)	TYPE	DIAMETER (IN)	FAN SPEED (RPM)	MAXIMUM OUTLET VELOCITY (FPM)	DISCHARGE DIRECTION	POWER (BHP)	RATED POWER (HP)	SPEED (RPM)	VDHz	LOCATION WITH RESPECT TO AIRSTREAM (IN OR OUT)	EMERGENCY POWER SOURCE REQUIRED (YES OR NO)	CONNECTED TO VFD? (YES OR NO)	WEIGHT (LBS)	MANUFACTURER	MODEL NUMBER	REMARKS						
AHU-1	FOURTH FLOOR MER 437	FOURTH FLOOR MER 437	1,500	1,500	0.48	DIRECT	PROPELLER	24	1,160	473	HORIZONTAL	0.22	0.25	1,160	1200/80	IN	NO	NO	75	GREENHECK	AER-24-03-6006	1.2							

NOTES:
1. PROVIDE FILTERED SUPPLY WALL HOUSING WITH 2" FILTERS.
2. PROVIDE OUTSIDE AIR DAMPER (GREENHECK MODEL WD-220), 120 V ACTUATOR, AND DAMPER END SWITCH.

- GENERAL NOTES**
- ANY WORK ASSOCIATED WITH REMOVAL OF ANY HAZARDOUS MATERIAL IS BEYOND SCOPE OF THIS CONTRACT. CONTRACTOR SHALL SUSPEND WORK AND NOTIFY OWNER IF PRESENCE OF HAZARDOUS MATERIALS IN WORK AREA IS SUSPECTED.
 - ANY INTERRUPTION OF EXISTING SERVICES AND/OR EQUIPMENT SHALL BE PERFORMED AT A TIME APPROVED IN ADVANCE BY THE FACILITY MANAGER SO AS NOT TO INTERFERE WITH THE PRESENT BUILDING OPERATION. SHUTDOWN TIMES AND DURATIONS WILL BE BASED ON BUILDING OCCUPANCY AND EXPECTED WEATHER.
 - THESE DRAWINGS ARE DIAGRAMMATIC AND INDICATE THE GENERAL EXTENT OF THE WORK. THE EXACT EXTENT OF DEMOLITION SHALL BE AS REQUIRED BY THE NEW WORK.
 - CONTRACTOR SHALL COORDINATE THE INSTALLATION OF PIPING, DUCTWORK AND EQUIPMENT WITH THE WORK OF ALL OTHER TRADES.
 - CONTRACTOR SHALL BE RESPONSIBLE FOR RELOCATION OF ANY EXISTING INTERFERENCES AS REQUIRED, INCLUDING EXISTING EQUIPMENT, MATERIALS, PIPING, CONDUIT, HANGERS, DEVICES, ETC., AT NO ADDITIONAL COST.
 - THE CONTRACTOR SHALL INCLUDE ALL OTHER ITEMS OR WORK REQUIRED TO COMPLETE THE WORK INCLUDING EQUIPMENT MOVING AND RIGGING, CAULKING, SEALING, INSERTS, SUPPORTS, HANGERS, SLEEVES, AND WALL PLATES.
 - THE CONTRACTOR SHALL PROVIDE ALL MISCELLANEOUS SUPPORTING STEEL REQUIRED FOR THE PROPER INSTALLATION OF ALL MECHANICAL SYSTEMS.
 - SHOP DRAWINGS AT 1/4"=1'-0" SCALE INDICATING DUCT, PIPE, AND EQUIPMENT LOCATIONS SHALL BE SUBMITTED BY INSTALLING CONTRACTORS FOR ENGINEERS REVIEW PRIOR TO INSTALLATION. FAILURE TO DO SO MAY RESULT IN THE INSTALLING CONTRACTOR BEING REQUIRED TO RELOCATE SUCH ITEMS AT THE DIRECTION OF THE ENGINEER OR OWNER AT THE CONTRACTOR'S EXPENSE.

- DEMOLITION PLAN NOTES - DUCTWORK**
- DEMOLISH EXISTING HOT WATER BOILER AND ASSOCIATED FLUE. EXISTING PAD TO REMAIN. EXISTING BURNER AND GAS TRAIN SHALL BE TURNED OVER TO OWNER. COORDINATE STORAGE LOCATION OF BURNER AND GAS TRAIN WITH OWNER.
 - REMOVE LOUVER TO FACILITATE NEW BOILER INSTALLATION. LOUVER APPROXIMATELY 85" TALL BY 112" WIDE. DIMENSIONS OF OPENING SHOULD BE VERIFIED BY CONTRACTOR.
 - CONTRACTOR SHALL RELOCATE EXISTING DRY PIPE SPRINKLER SYSTEM AS NEEDED TO ACCOMMODATE NEW BOILERS AND ASSOCIATED FLUE AND COMBUSTION AIR DUCT.
 - DEMOLISH EXISTING MAKE-UP AIR-HANDLING UNIT (AH-1) AND ACCESSORIES. AIR-HANDLING UNIT TO BE REPLACED WITH SUPPLY FAN AHU-1.
 - DEMOLISH EXISTING BAROMETRIC DAMPER AND HOUSING. EXISTING HOOD ON ROOF TO REMAIN. DAMPER TO BE REPLACED WITH NEW MOTORIZED DAMPER.

- PRE-CONSTRUCTION TEST AND BALANCE**
- PRIOR TO START OF DEMOLITION WORK, SET MIXING VALVE OPEN SUCH THAT ALL FLOW IS THROUGH THE BOILERS AND NO FLOW IS IN THE BYPASS. MEASURE WATER FLOW AT INDICATED POINTS FIRST WITH HOT WATER PUMP P-3 AT NORMAL OPERATING FLOW AND HOT WATER PUMP P-4 OFF. THEN MEASURE WATER FLOW AT THE SAME INDICATED POINTS WITH HOT WATER PUMP P-3 OFF AND HOT WATER PUMP P-4 AT NORMAL OPERATING FLOW.

- DEMOLITION PLAN NOTES - PIPING**
- DEMOLISH EXISTING HOT WATER BOILER. ASSOCIATED GAS PIPING AS INDICATED. HYDRONIC PIPING AS INDICATED. EXISTING PAD TO REMAIN. EXISTING BURNER AND GAS TRAIN SHALL BE TURNED OVER TO OWNER. COORDINATE STORAGE LOCATION OF BURNER AND GAS TRAIN WITH OWNER.
 - DEMOLISH EXISTING IN-LINE CIRCULATING PUMP. 2" HOT WATER CIRCULATION PIPING, AND ACCESSORIES.
 - CONTRACTOR SHALL RELOCATE EXISTING DRY PIPE FIRE SPRINKLER SYSTEM AS NEEDED TO ACCOMMODATE NEW BOILERS AND ASSOCIATED PIPING.
 - DEMOLISH EXISTING MAKE-UP AIR-HANDLING UNIT (AH-1) AND ACCESSORIES. PREPARE HOT WATER SUPPLY AND RETURN PIPING FOR CONNECTION TO NEW UNIT HEATER (UH-30).

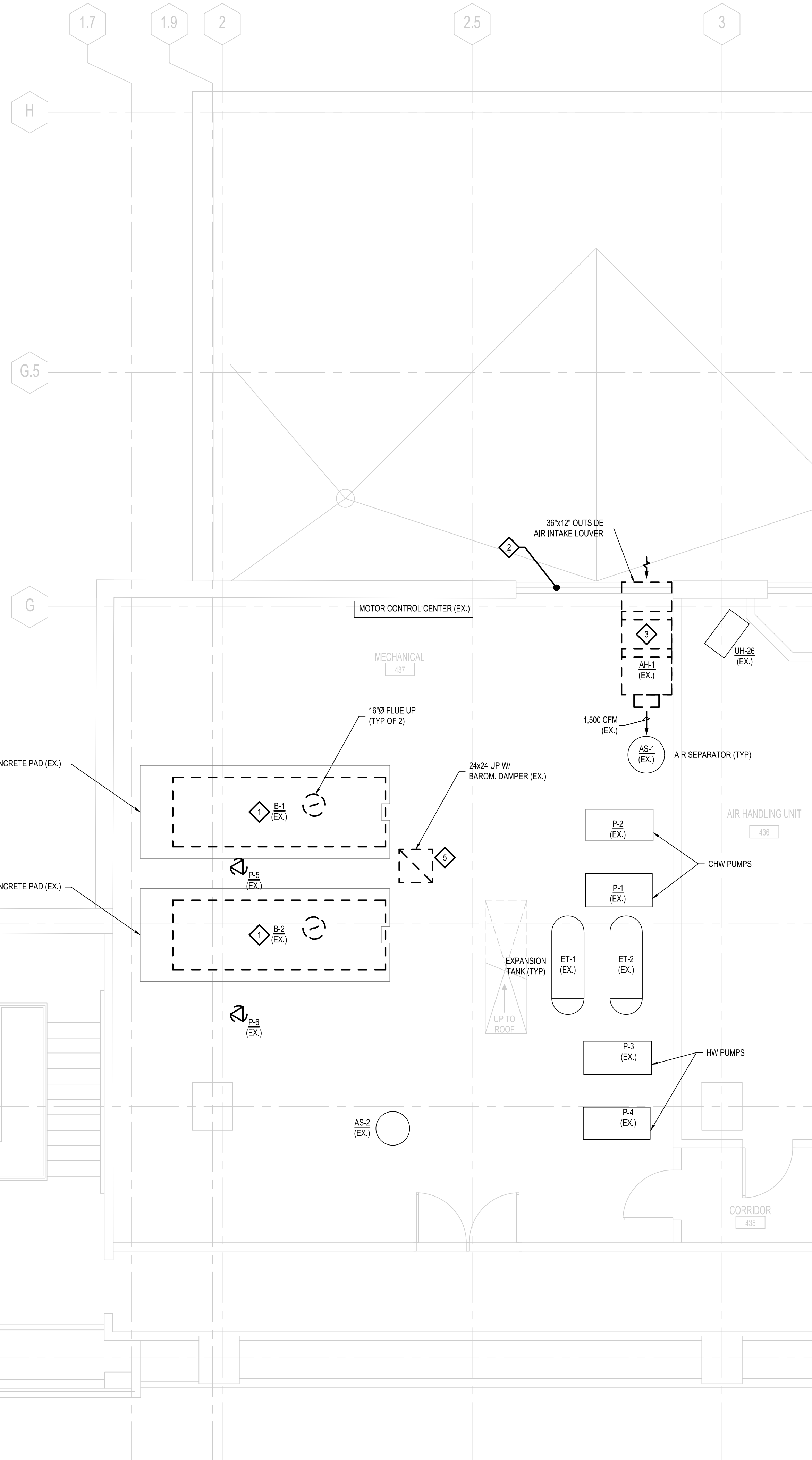

1 4TH FLOOR MECHANICAL PLAN - DUCTWORK DEMOLITION

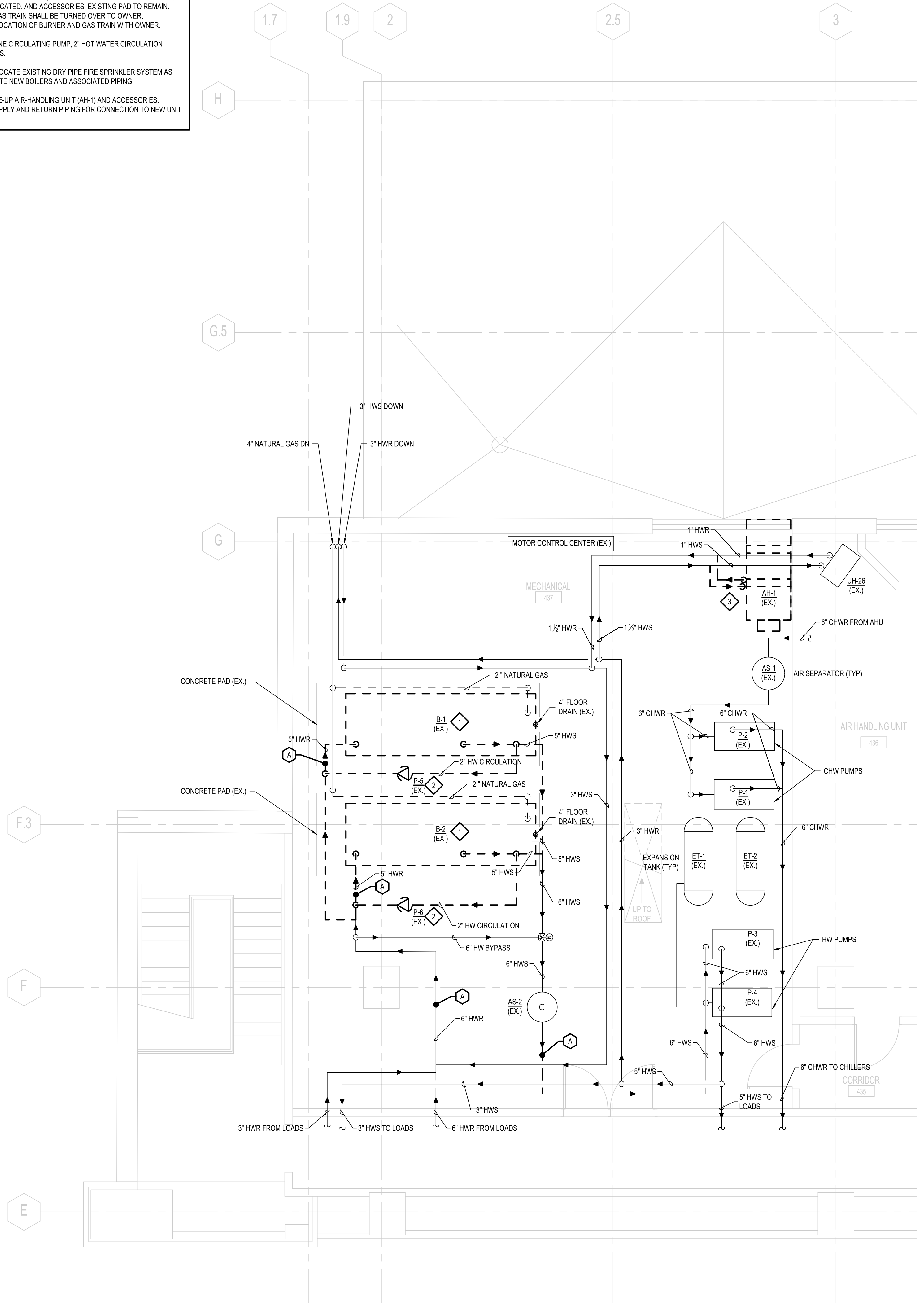

2 4TH FLOOR MECHANICAL PLAN - PIPING DEMOLITION



Grumman/Butkus Associates
 Energy Efficiency Consulting and Sustainable Design Engineers
 820 Davis St, Ste 300
 Evanston, Illinois 60201 4446
 847.328.3555 grummanbutkus.com

CONSULTANTS
 SEAL

4TH FLOOR MECHANICAL PLAN - DEMOLITION
 EVANSTON PUBLIC LIBRARY BOILER REPLACEMENT
 1703 ORRINGTON, EVANSTON IL

ISSUES & REVISIONS

NO.	DESCRIPTION	DATE
1	OWNER REVIEW	03/02/2023
2	ISSUED FOR BICPERMIT	03/17/2023

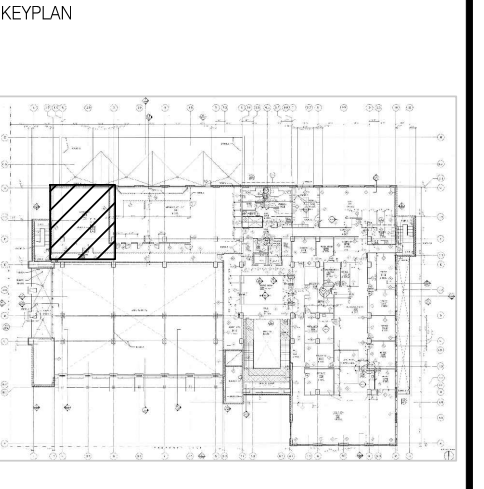

SCALE: 0 1 2 4 8
 1/4"=1'-0"

DRAWN	CHECKED	APPROVED
ACR	ARS	JET

PROJECT NO. P22-1142-00

MD100

P:\22 P22-1142-00\22-1142-00-01.dwg 12/28/2022 10:58:05 AM 1/4"=1'-0"

GENERAL NOTES

- THESE DRAWINGS ARE DIAGRAMMATIC AND INDICATE THE GENERAL EXTENT OF THE WORK.
- CONTRACTOR TO PROVIDE ALL PIPING, BOILERS, DUCTWORK, AND OTHER DEVICES SHOWN.
- RELOCATE AND RECONFIGURE EXISTING SUPPORTS FOR DUCTWORK, PIPING, CONDUITS, AND OTHER DEVICES AS REQUIRED TO ACCOMMODATE INSTALLATION OF NEW DUCTWORK, PIPING, AND ASSOCIATED ACCESSORIES AS SHOWN ON DRAWINGS. FIELD VERIFY EXTENT OF SUPPORT RELOCATION SCOPE OF WORK.
- PROVIDE WATER TREATMENT PER SPEC SECTION 23 2500 PIPE CLEANING, FLUSHING AND CHEMICAL TREATMENT.

CONSTRUCTION PLAN NOTES - DUCTWORK

- INSTALL NEW BOILER ON EXISTING PAD.
- INSTALL NEW 12" DOUBLE WALL STAINLESS STEEL FLUE (SAF-T VENT CI 316 OR EQUIVALENT), ROUTE IN FIELD TO UTILIZE EXISTING ROOF OPENING. PITCH FLUE AS NECESSARY TO ENSURE PROPER DRAINAGE OF CONDENSATE. REFER TO "BOILER STACK EXHAUST DETAIL" ON SHEET M300 FOR GENERAL ROUTE.
- TERMINATE FLUE AT LEAST 3' ABOVE ROOF LINE. INSTALL EXIT CONE AT TERMINATION. PROVIDE FLASHING AND COUNTERFLASHING AT ROOF AS REQUIRED. COORDINATE WITH EXISTING BUILDING CONSTRUCTION.
- INSTALL NEW 12" GALVANIZED STEEL OR PVC DUCT FOR COMBUSTION AIR. INSULATE DUCT PER OUTDOOR AIR DUCT REQUIREMENTS IN SPEC 20 0700 THERMAL INSULATION. REFER TO "COMBUSTION INLET DETAIL" ON SHEET M300 FOR OUTSIDE INTAKE AND PITCH REQUIREMENTS. COORDINATE EXACT ROUTING IN FIELD TO MINIMIZE CONFLICTS WITH EXISTING LIGHTS AND DRY PIPE SPRINKLERS. INCLUDE RELOCATION OF UP TO FOUR (4) SPRINKLER HEADS.
- INSTALL NEW SUPPLY FAN (AHU-1) WITH FILTERED SUPPLY WALL HOUSING AND OUTSIDE AIR DAMPER WITH ACTUATOR. INSTALL ASSOCIATED THERMOSTAT. MODIFY EXISTING OUTSIDE AIR INTAKE TO ACCOMMODATE NEW FILTERED SUPPLY FAN.
- INSTALL NEW UNIT HEATER (UH-30) AND ASSOCIATED THERMOSTAT.
- MODIFY EXISTING STEEL LOUVER AS REQUIRED TO ACCOMMODATE NEW COMBUSTION AIR INLETS AND SUPPLY FAN OUTSIDE AIR CONNECTION.
- TERMINATE COMBUSTION INTAKES FULLY OUTSIDE OF EXISTING LOUVER. COORDINATE EXACT TERMINATION IN FIELD.
- INSTALL NEW BOILER OUTSIDE AIR TEMPERATURE SENSOR PER MANUFACTURER RECOMMENDATIONS. LOCATE NEAR EXISTING OUTSIDE AIR SENSORS (NOT SHOWN ON DRAWING), SHIELD FROM SUNLIGHT. EXISTING OUTSIDE AIR SENSORS TO REMAIN.
- INSTALL NEW SPACE TEMPERATURE SENSOR AND WIRE TO BAS.
- INSTALL NEW 24x24 DAMPER WITH ACTUATOR AND ASSOCIATED HOUSING FOR DAMPER IN PLACE OF DEMOLISHED BAROMETRIC DAMPER. CONNECT TO EXISTING HOOD ON ROOF AND SEAL AROUND HOUSING TO MAKE WEATHER TIGHT.

CONSTRUCTION PLAN NOTES - PIPING

- INSTALL NEW BOILER ON EXISTING PAD. REFER TO "FLOW DIAGRAM - NEW WORK" ON SHEET M300 FOR REQUIRED VALVES, FITTINGS, CONDENSATE TRAP, AND CONDENSATE NEUTRALIZATION BASIN.
- INSTALL NEW 2-POSITION CONTROL VALVE. REFER TO "FLOW DIAGRAM - NEW WORK" ON SHEET M300 FOR ADDITIONAL REQUIRED VALVES AND FITTINGS.
- LOCK 3-WAY MIXING VALVE FULL OPEN TO PIPING FROM BOILERS AND FULL CLOSED TO BYPASS. NO WATER SHALL FLOW THROUGH BYPASS.
- INSTALL NEW SUPPLY HEADER TEMPERATURE SENSOR IN EXISTING PIPING DOWNSTREAM OF HOT WATER PUMPS AND UPSTREAM OF ANY TAKEOFFS.
- RELOCATE EXISTING DRY PIPE FIRE SPRINKLER SYSTEM AS NEEDED TO ACCOMMODATE NEW BOILERS AND ASSOCIATED PIPING.
- CONNECT NEW 2" GAS LINE TO EXISTING HEADER. PROVIDE GAS LINE PRESSURE REGULATOR IN GAS LINE AND A MANUAL SHUT OFF VALVE BEFORE AND AFTER THE REGULATOR. PROVIDE REDUCER AT BOILER FOR 2" CONNECTION.
- INSTALL NEW UNIT HEATER (UH-30) AND PROVIDE PIPING TO CONNECT TO EXISTING HOT WATER RETURN AND SUPPLY PIPING. REFER TO "HOT WATER UNIT HEATER PIPING DETAIL - NO CONTROL VALVE" ON SHEET M300 FOR REQUIRED FITTINGS.

POST-CONSTRUCTION TEST AND BALANCE

POST-CONSTRUCTION THE FLOWS SHALL BE BALANCED AS FOLLOWS USING EACH BOILER'S BALANCING VALVE AND THE TRIPLE DUTY VALVES AT THE PUMPS P-3 & P-4:

- WHEN ONLY B-1 IS ENABLED, THE FLOW THROUGH B-1 WITH EITHER P-3 OR P-4 SHALL BE WITHIN 5% OF THE PRE-CONSTRUCTION TEST AND BALANCE SYSTEM FLOW VALUE.
- WHEN ONLY B-2 IS ENABLED, THE FLOW THROUGH B-2 WITH EITHER P-3 OR P-4 SHALL BE WITHIN 5% OF THE PRE-CONSTRUCTION TEST AND BALANCE SYSTEM FLOW VALUE.
- WITH B-1 AND B-2 ENABLED AND FLOW THROUGH BOTH BOILERS AND WITH EITHER P-3 OR P-4 ENABLED, THE FLOW THROUGH EACH BOILER SHALL BE WITHIN 10% OF THE OTHER. TOTAL FLOW SHALL BE AT LEAST EQUAL TO THE PRE-CONSTRUCTION TEST AND BALANCE SYSTEM FLOW VALUE.

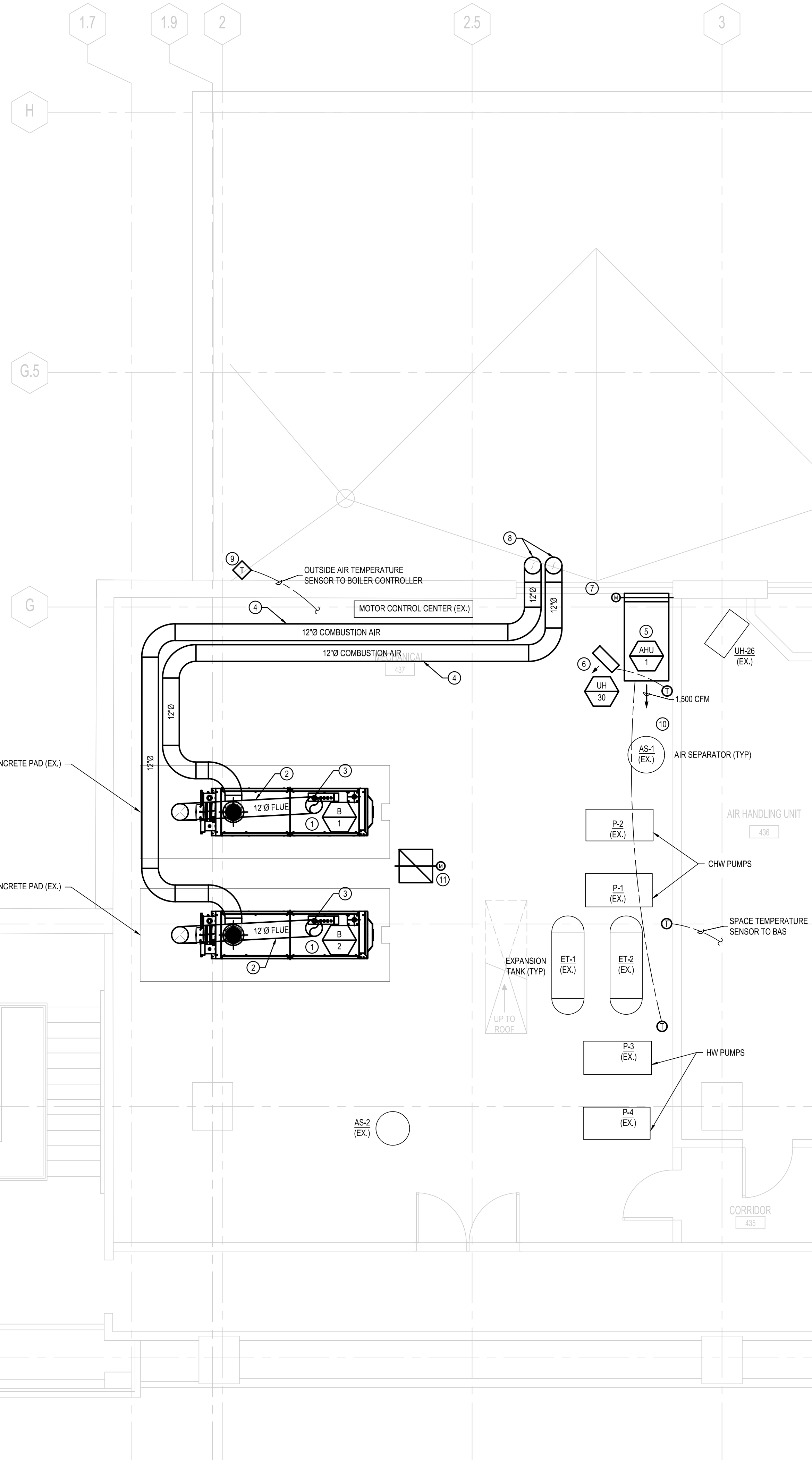

1 4TH FLOOR MECHANICAL PLAN - DUCTWORK NEW WORK

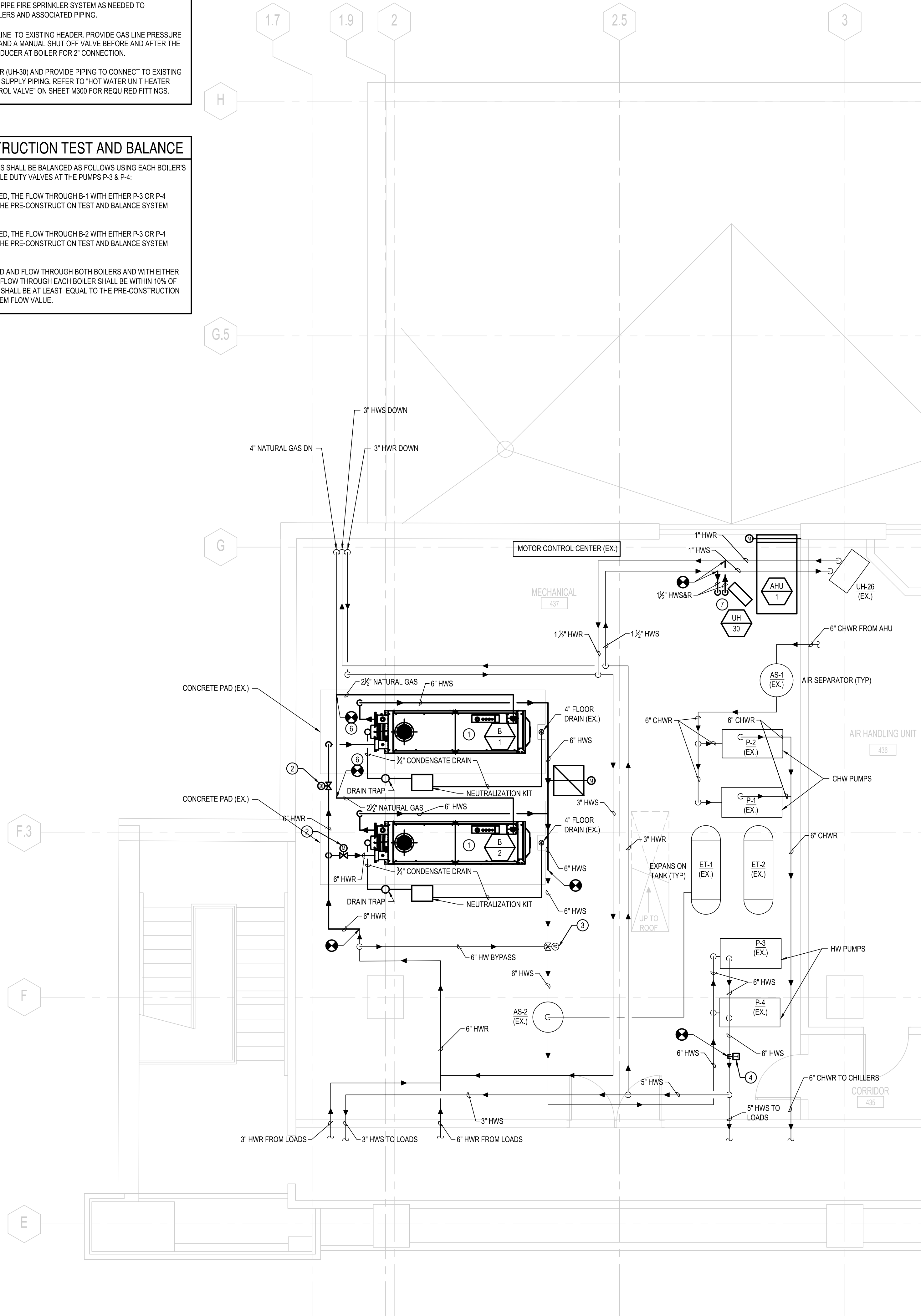

2 4TH FLOOR MECHANICAL PLAN - PIPING NEW WORK



Grumman/Butkus Associates
 Energy Efficiency Consulting and Sustainable Design Engineers
 820 Davis St, Ste 300
 Evanston, Illinois 60201 4446
 847.328.3555 grummanbutkus.com

CONSULTANTS

SEAL

4TH FLOOR MECHANICAL PLAN - NEW WORK
 EVANSTON PUBLIC LIBRARY BOILER REPLACEMENT
 1703 ORRINGTON, EVANSTON IL

ISSUES & REVISIONS		
NO.	DESCRIPTION	DATE
OWNER REVIEW		03/02/2023
ISSUED FOR BIDDING		03/17/2023

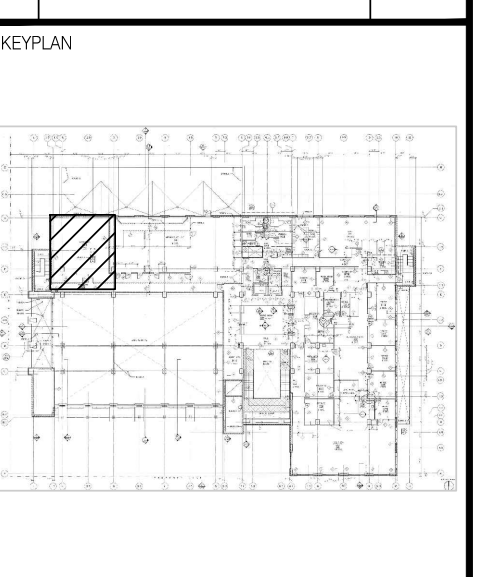

SCALE: 0 1 2 4 8
 1/4" = 1'-0"

DRAWN: ACR CHECKED: AHS APPROVED: JET

PROJECT NO.: P22-1142-00

M100

P:\23 PROJECTS\22-1142-0000\04_03\23\0318.dwg (DWG) 03/17/2023 10:58:05 AM

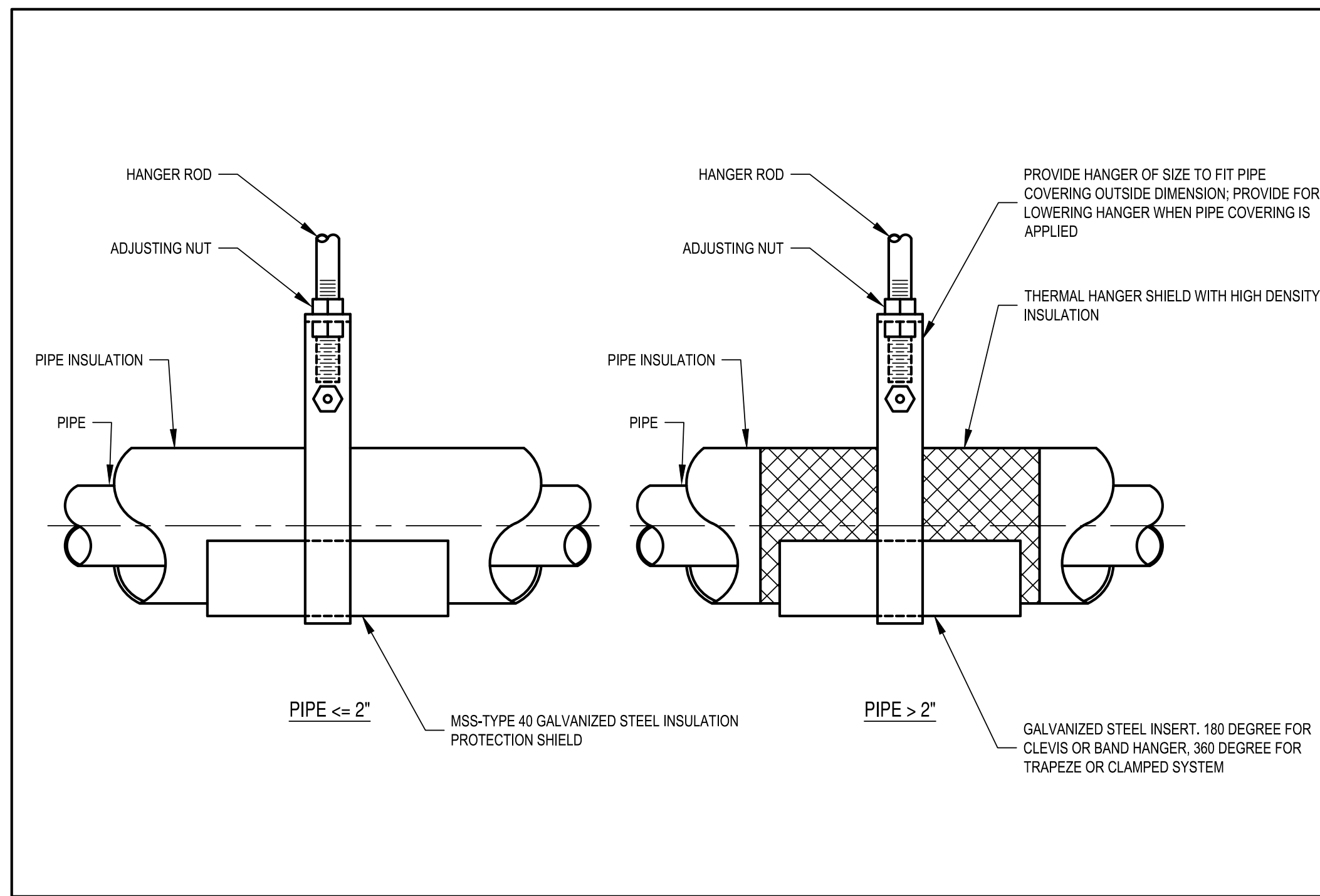

PIPE INSULATION SHIELD DETAIL

NO SCALE

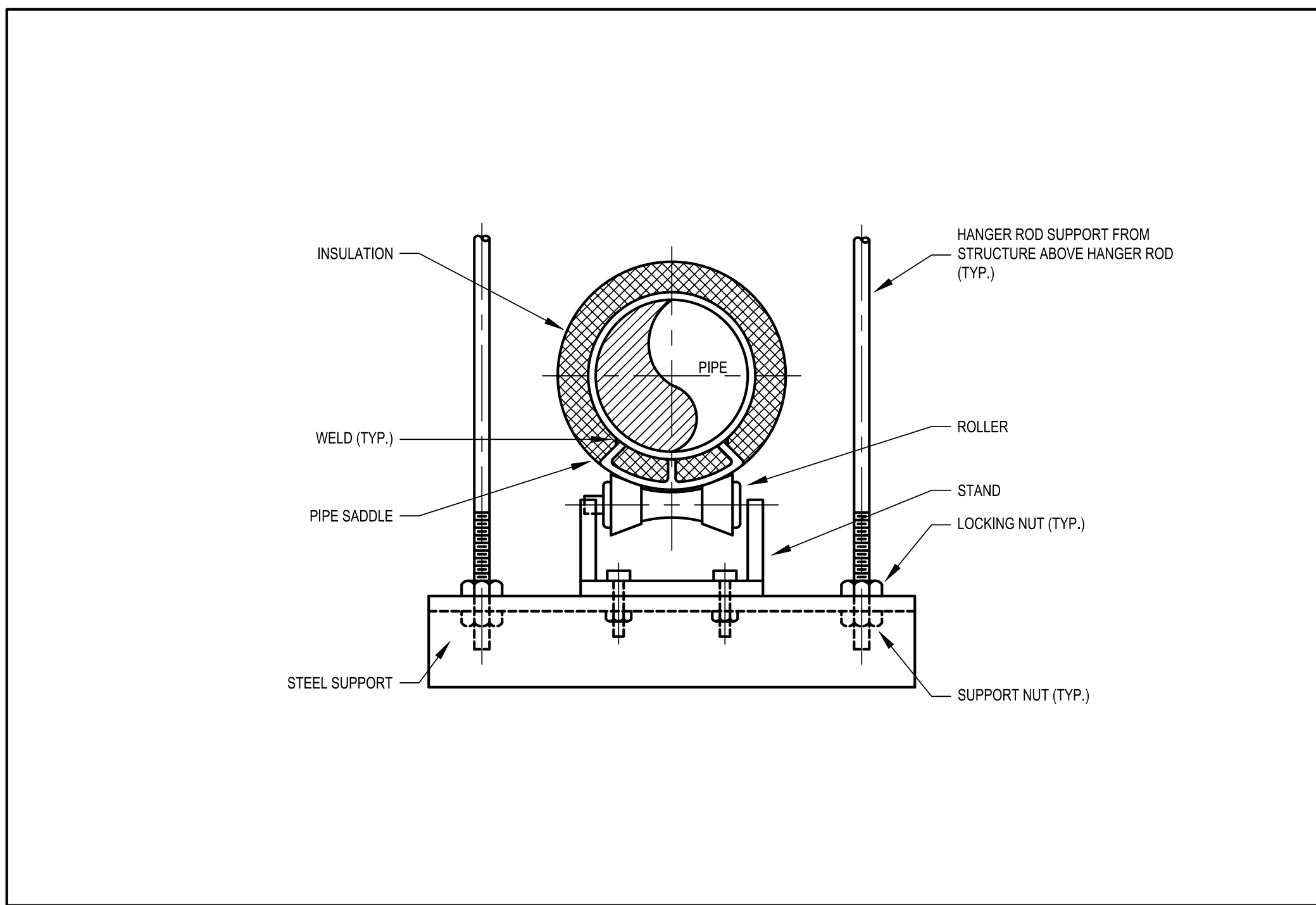

PIPE ROLLER HANGER DETAIL FOR HEATING HOT WATER PIPING

NO SCALE

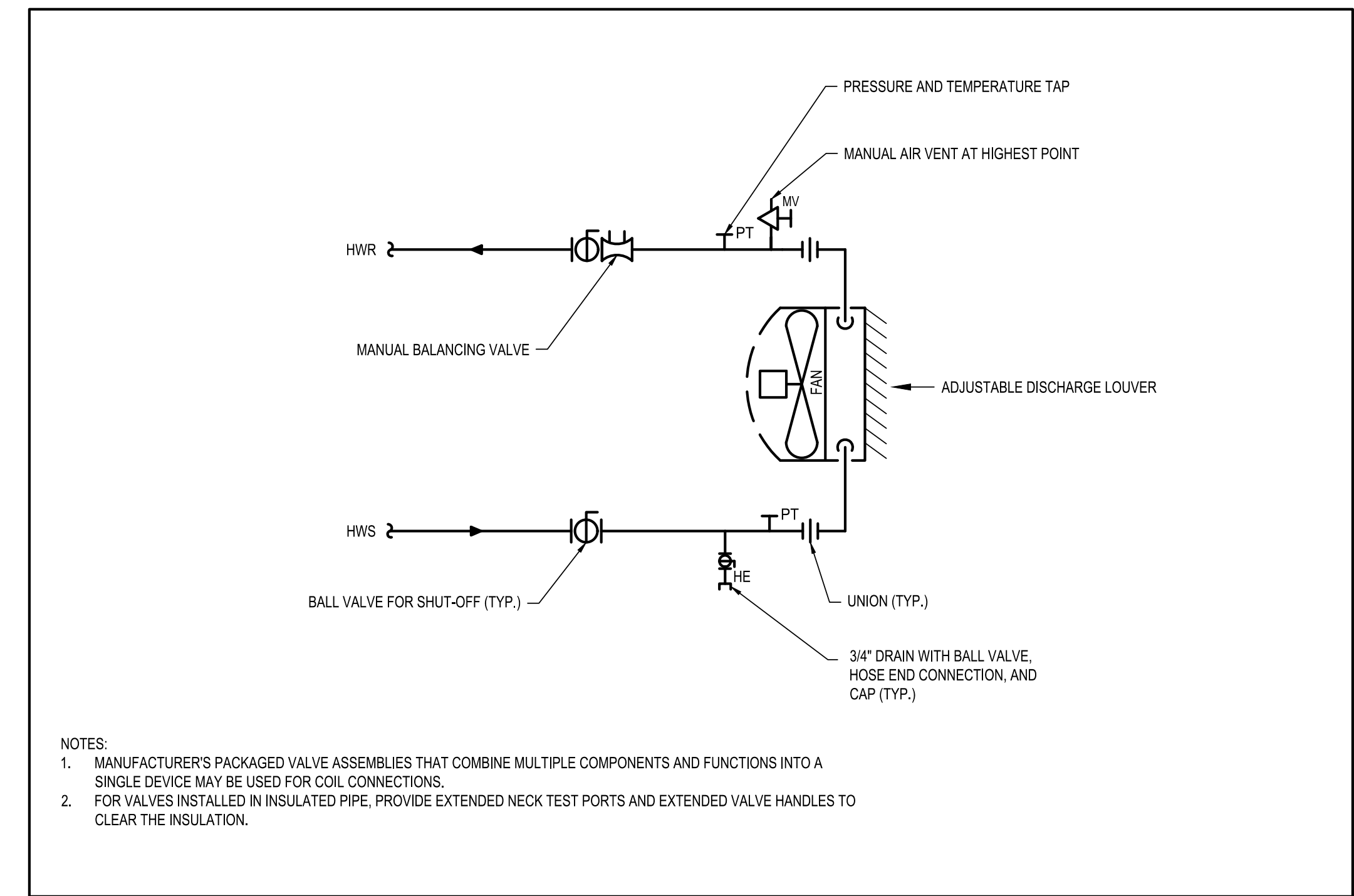

HOT WATER UNIT HEATER PIPING DETAIL - NO CONTROL VALVE

NO SCALE

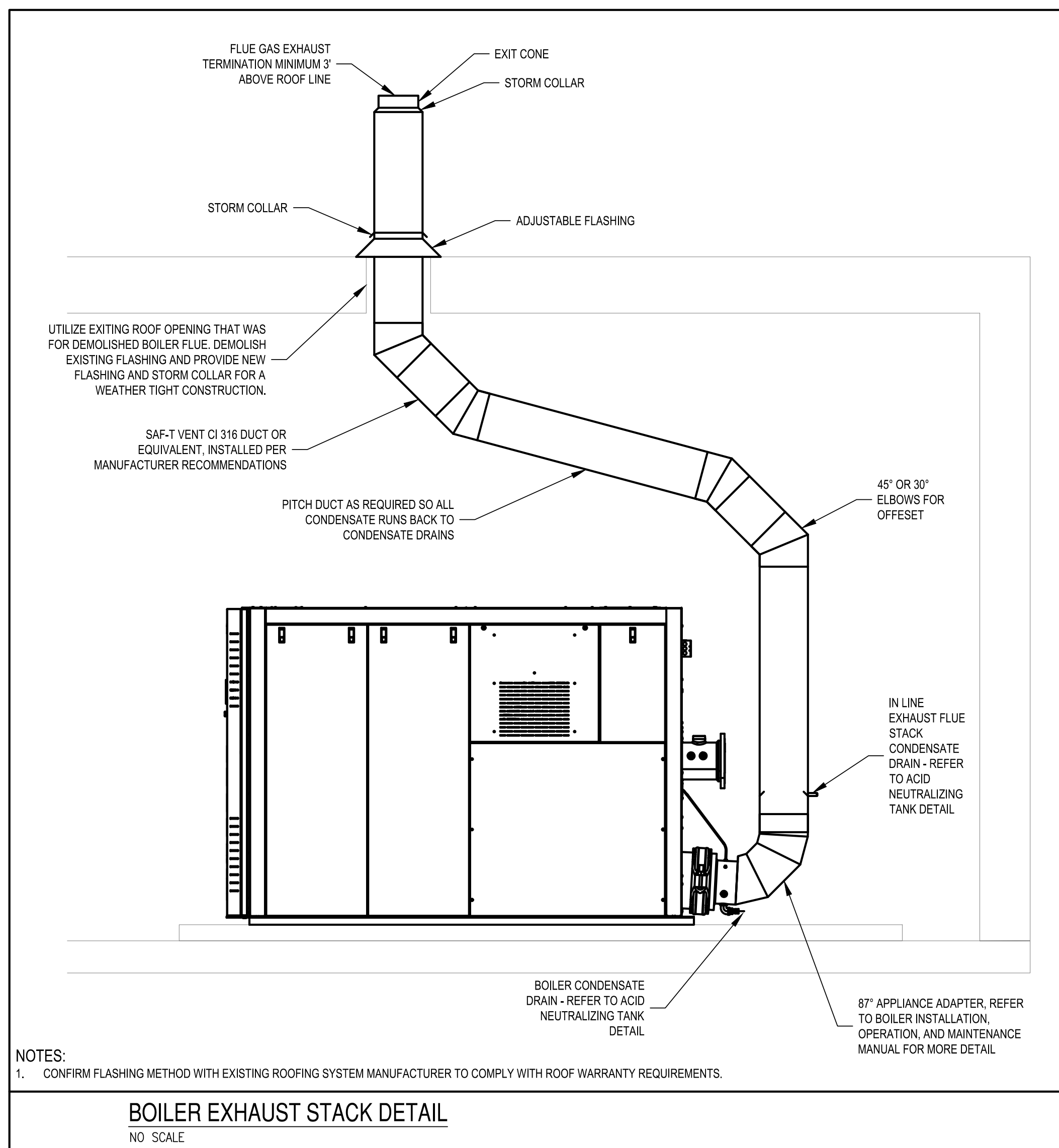

BOILER EXHAUST STACK DETAIL

NO SCALE

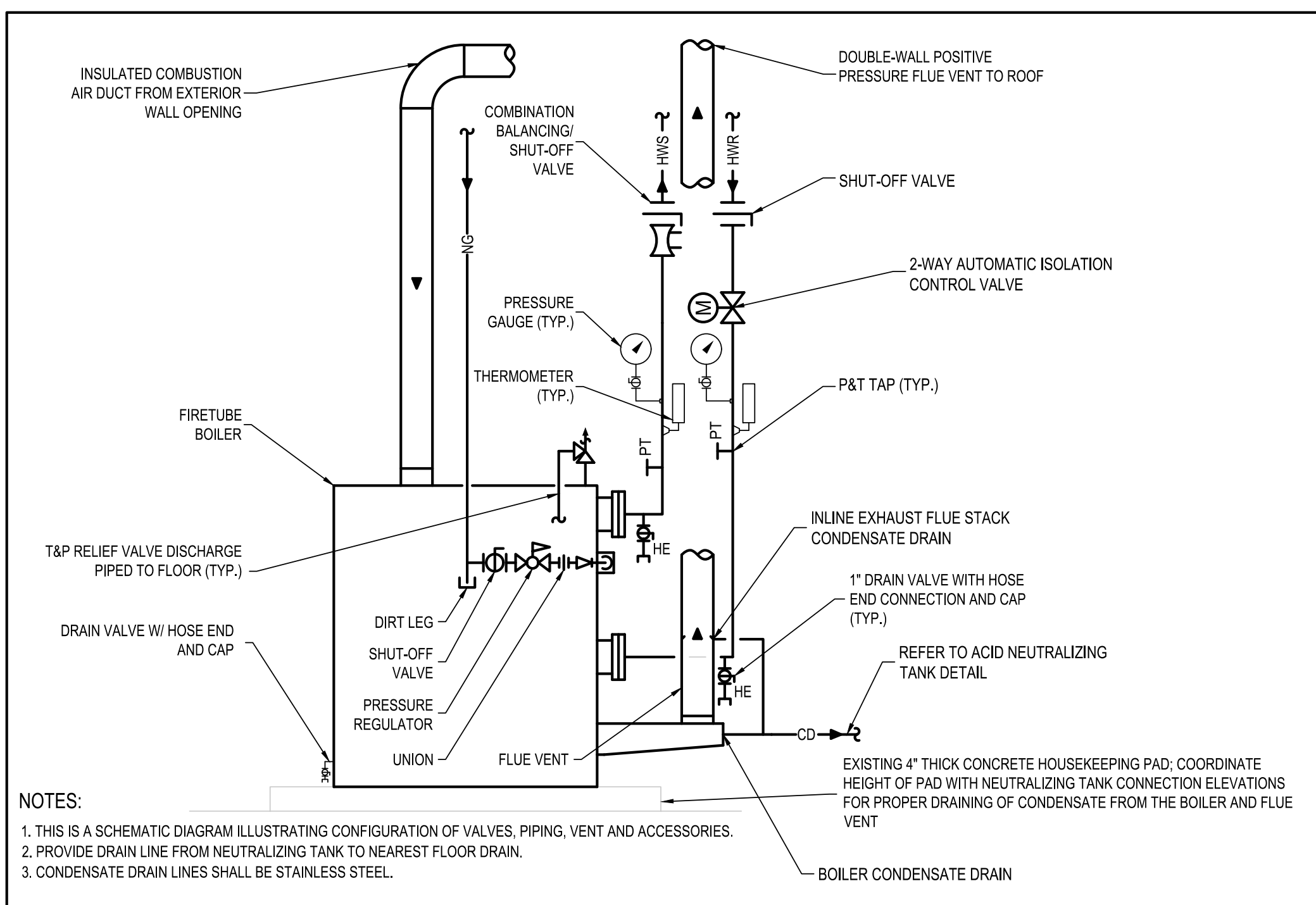

HOT WATER CONDENSING BOILER PIPING AND VENT CONNECTION DETAIL

NO SCALE

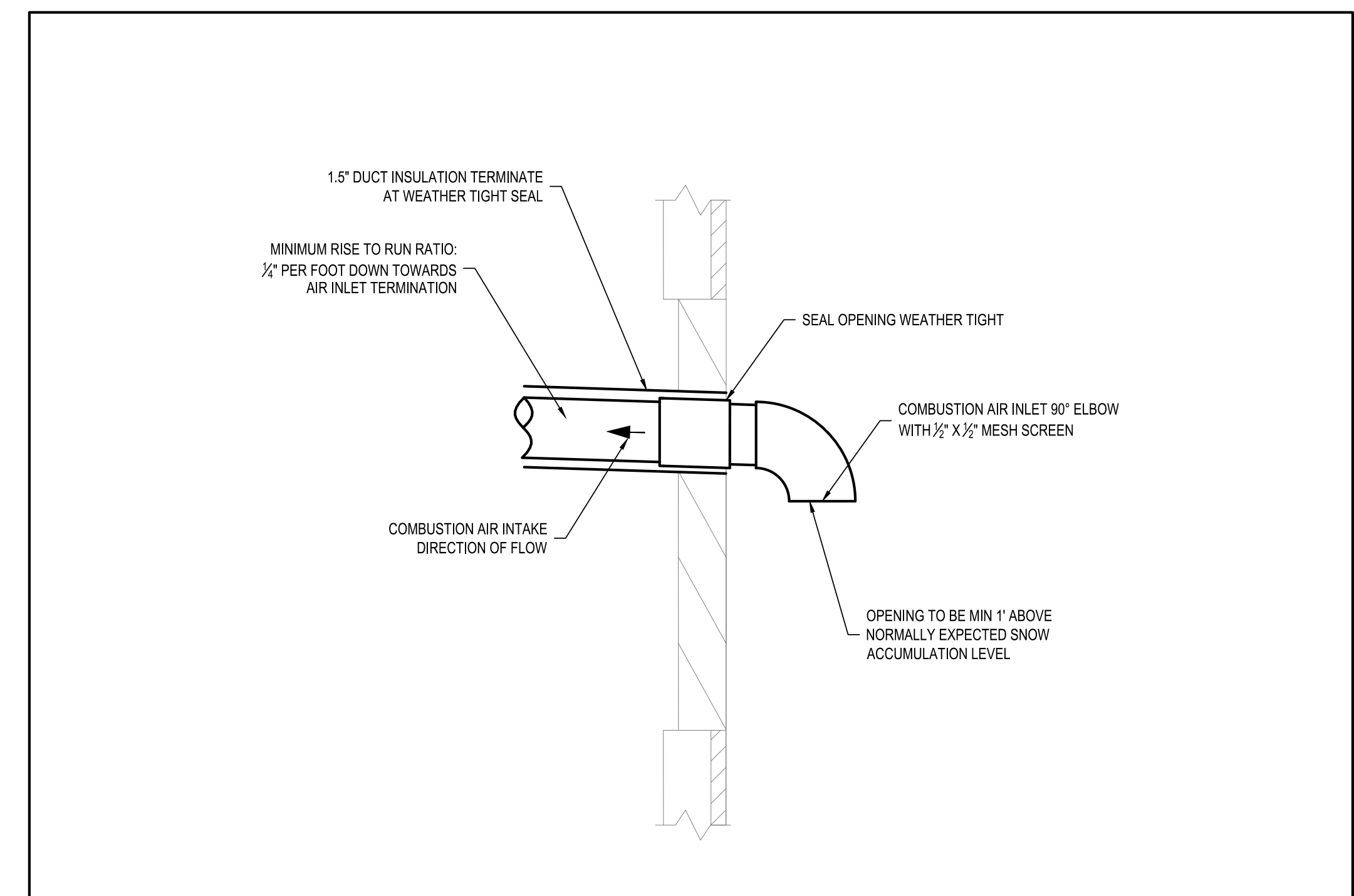

COMBUSTION INTAKE

NO SCALE

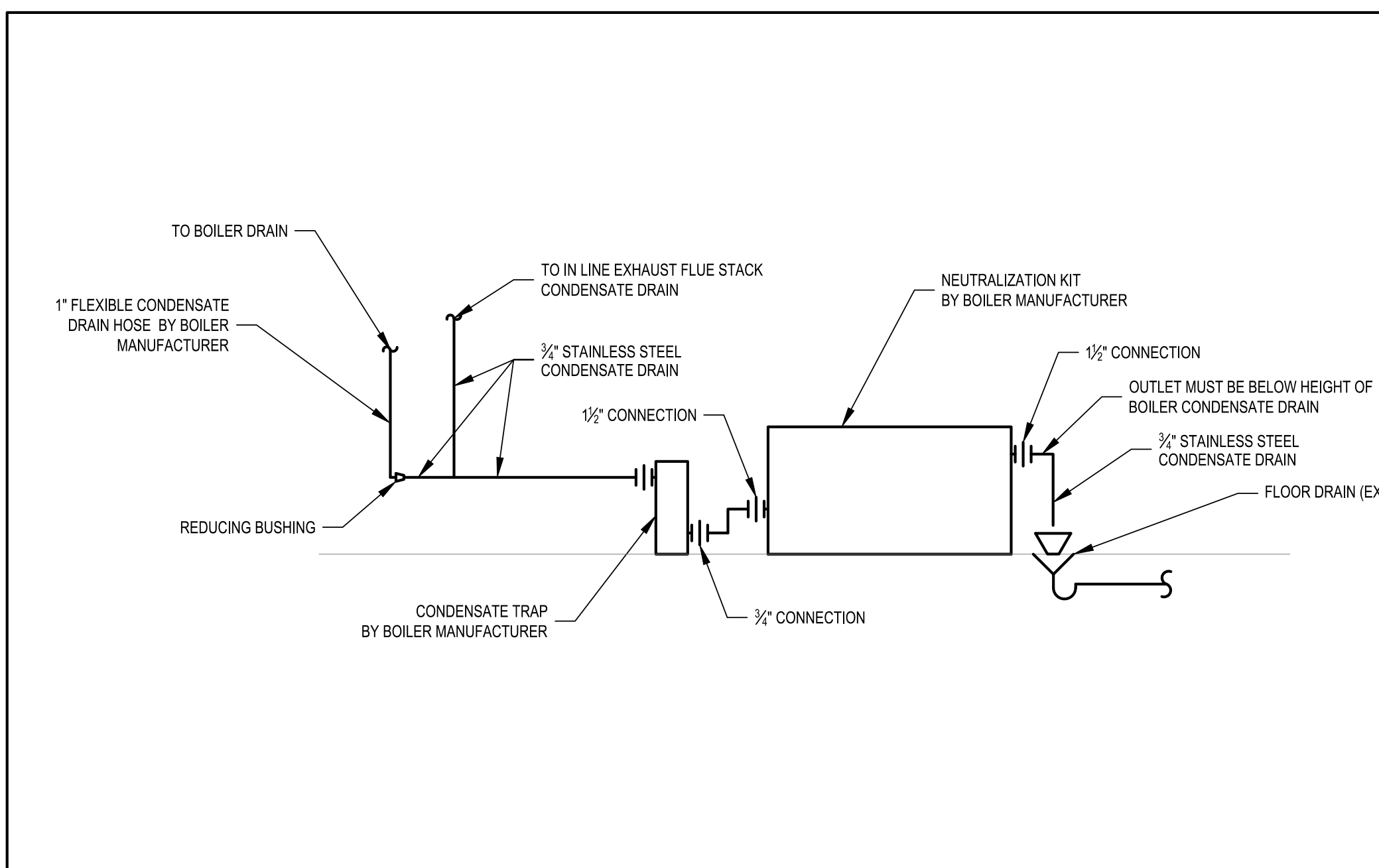

ACID NEUTRALIZING TANK DETAIL

NO SCALE



Grumman/Butkus Associates
Energy Efficiency Consultants and Sustainable Design Engineers

820 Davis St. Ste 300
Evanston, Illinois 60201 4446
847.328.3555 grummanbutkus.com

CONSULTANTS

SCALE

MECHANICAL DETAILS
EVANSTON PUBLIC LIBRARY BOILER REPLACEMENT
1703 ORRINGTON, EVANSTON IL

ISSUES & REVISIONS		
NO.	DESCRIPTION	DATE
OWNER REVIEW		03/02/2023
ISSUED FOR BOP/PERMIT		03/17/2023

REVISION

SCALE
NO SCALE

DRAWN: ACR CHECKED: ARS APPROVED: JET

PROJECT NO. P22-1142-00

M300

FILE: P:\PROJECTS\22-1142-0002\01.dwg DATE: 03/17/2023 10:58:05 AM USER: JET

ELECTRICAL SHEET SPECIFICATION - BASIC ELECTRICAL MATERIALS AND METHODS

- 1.0 GENERAL
 - 1.1 SCOPE: THE WORK SPECIFIED IN THESE NOTES INCLUDES, BUT SHALL NOT BE LIMITED TO, PROVIDING LABOR, MATERIAL, EQUIPMENT, AND SERVICES NECESSARY FOR THE CONSTRUCTION OF THE ELECTRICAL SYSTEM, INCLUDING THE ELECTRICAL GROUNDING SYSTEM, AS HEREIN SPECIFIED.
 - 1.2 REFER TO ARCHITECTURAL, MECHANICAL, OR PLUMBING/FIRE PROTECTION DRAWINGS FOR ADDITIONAL INFORMATION AND COORDINATION.
 - 1.3 THE CONTRACTOR SHALL BE RESPONSIBLE FOR SHOP DRAWING SUBMITTALS WHICH SHALL INCLUDE, BUT NOT BE LIMITED TO, A MINIMUM OF FIVE (5) COPIES OF PRODUCT DATA AND EQUIPMENT SPECIFICATIONS SHEETS, SCHEMATIC DIAGRAMS, WIRING DIAGRAMS, SIZES, MOUNTING DETAILS (WITH REQUIRED ELEVATIONS), TECHNICAL DESCRIPTIONS OF COMPONENTS, TEST REPORTS, CERTIFICATES OF OPERATING AND MAINTENANCE MANUALS, AND PROPER CALCULATIONS TO ENSURE SPECIFIED PERFORMANCE OF THE SYSTEMS. ALL SUBMITTALS SHALL BE SENT IN DIGITAL (PDF) FORMAT. NO EQUIPMENT SHALL BE ORDERED, PURCHASED, OR INSTALLED WITHOUT PRIOR APPROVAL BY THE ENGINEER OF THE SUBMITTALS AND SHOP DRAWINGS.
 - 1.4 ALL WORK SHALL COMPLY WITH THE ELECTRICAL CODE APPROVED BY THE LOCAL AUTHORITY, AND ALL OTHER APPLICABLE FEDERAL, STATE AND LOCAL CODES, WHERE THE CONSTRUCTION DOCUMENTS INDICATE MORE RESTRICTIVE REQUIREMENTS, THE CONSTRUCTION DOCUMENTS SHALL GOVERN BUT THE CONSTRUCTION DOCUMENTS SHALL NOT BE INTERPRETED AS AUTHORITY TO VIOLATE ANY CODE OR REGULATION.
 - 1.5 NOT ALL EXISTING CONVENIENCE RECEPTACLES, WALL SWITCHES, LIGHTS, ETC., AND OTHER ELECTRICAL EQUIPMENT ARE SHOWN ON THE PLANS. A SURVEY OF THE JOB SITE MUST BE MADE TO DETERMINE THE EXTENT OF EXISTING ELECTRICAL EQUIPMENT.
 - 1.6 IN THE EVENT OF A CONFLICT OR INCONSISTENCY BETWEEN ITEMS INDICATED ON THE PLANS AND/OR SPECIFICATION NOTES OR WITH CODE REQUIREMENTS, THE NOTE, SPECIFICATION OR CODE WHICH PRESCRIBES AND ESTABLISHES THE MORE COMPLETE JOB OR THE HIGHER STANDARD SHALL PREVAIL.
 - 1.7 OMISSIONS FROM THE DRAWINGS, SPECIFICATION NOTES, OR THE OF DETAILS OF WORK WHICH ARE NECESSARY TO CARRY OUT THE INTENT OF THE DRAWINGS AND SPECIFICATIONS, OR WHICH ARE CUSTOMARILY PERFORMED, SHALL NOT RELIEVE THE CONTRACTOR FROM PERFORMING SUCH OMITTED DETAILS OF THE WORK BUT THEY SHALL BE PERFORMED AS IF FULLY AND CORRECTLY SET FORTH AND DESCRIBED IN THE DRAWINGS AND SPECIFICATIONS.
 - 1.8 THE CONTRACTOR SHALL CHECK ALL DRAWINGS FURNISHED IMMEDIATELY UPON RECEIPT AND SHALL PROMPTLY NOTIFY THE OWNER OF ANY DISCREPANCIES, FIGURES MARKED ON DRAWINGS SHALL IN GENERAL BE FOLLOWED IN PREFERENCE TO SCALE MEASUREMENTS. LARGE SCALE DRAWINGS SHALL IN GENERAL GOVERN SMALL SCALE DRAWINGS. THE CONTRACTOR SHALL COMPARE ALL DRAWINGS AND VERIFY THE FIGURES BEFORE LAYING OUT THE WORK AND WILL BE RESPONSIBLE FOR ANY ERRORS WHICH MIGHT HAVE BEEN AVOIDED THEREBY.
 - 1.9 THE CONTRACTOR SHALL FURNISH ALL PERMITS AND PAY ALL FEES.
- 2.0 PRODUCTS AND MATERIALS
 - 2.1 RACEWAYS
 - A. CONDUIT AND FITTINGS INSTALLED FOR MOTOR CIRCUITS, FEEDER CIRCUITS, IN CONCRETE SLABS ON GRADE, EXPOSED TO WEATHER, BURIED UNDERGROUND OR EXPOSED WHERE SUBJECT TO MECHANICAL INJURY SHALL BE RIGID GALVANIZED STEEL, RIGID OR INTERMEDIATE METAL CONDUIT (IMC) COMPLYING ANS C80.1, FITTINGS SHALL BE THREADED.
 - B. CONDUIT AND FITTINGS INSTALLED FOR CONCEALED INTERIOR WORK FOR LIGHTING RECEPTACLES/ BRANCH CIRCUITS, FIRE ALARM, PAGING, SIGNAL, AND LOW VOLTAGE CIRCUITS SHALL BE ELECTRICAL METAL TUBING (EMT) COMPLYING WITH NEMA FB C80.3, EMT FITTINGS SHALL BE ZINC PLATED COMPRESSION TYPE, SET SCREW FITTINGS ARE NOT PERMITTED.
 - C. FRAIL CONNECTIONS TO MOTORS, TRANSFORMERS, AND VIBRATING EQUIPMENT SHALL BE MADE WITH LIQUIDTIGHT FLEXIBLE METAL CONDUIT (LFMC).
 - D. MINIMUM SIZE CONDUIT SHALL BE 3/4 INCH (19 MM) EXCEPT THAT CONTROL, SIGNAL, AND TWO-WIRE LIGHTING SWITCH LEADS MAY BE 1/2 INCH (13 MM).
 - E. RACEWAYS SHALL BE SECURELY SUPPORTED BY APPROVED METHODS AT FIVE FOOT (5) INTERVALS.
 - F. PULL BOXES ARE REQUIRED IN RUNS OVER 100 FEET, WHEN MORE THAN THE EQUIVALENT OF THREE (3) 90° BENDS ARE USED, AND AS SHOWN ON DRAWINGS.
 - 2.2 BOXES
 - A. PULL AND JUNCTION BOXES AND COVERS SHALL BE FABRICATED FROM GALVANIZED NEC GAGE SHEET STEEL. OUTLET BOXES TO BE OF THE HOT-DIPPED GALVANIZED, PRESSED STEEL, KNOCKOUT TYPE. BOXES SHALL GENERALLY BE 4 INCHES SQUARE EXCEPT WHERE NOTED OTHERWISE.
 - 2.3 WIRE AND CABLE
 - A. UNLESS NOTED OTHERWISE, CONDUCTORS FOR POWER AND LIGHTING SHALL BE COPPER, #12 AWG MINIMUM WITH 600 VOLT INSULATION, TYPE THHN, 90 DEGREE C, CONFORMING TO THE LATEST NEC AND SHALL BEAR UL LABEL.
 - B. BRANCH CIRCUIT WIRING SHALL BE SOLID COPPER WHEN #10 AWG OR SMALLER, UNLESS OTHERWISE SPECIFIED. WIRE #8 AWG AND LARGER SHALL BE STRANDED COPPER.
 - C. WIRE FOR SIGNAL AND CONTROL SYSTEMS SHALL BE #14 AWG, UNLESS OTHERWISE NOTED.
 - 2.4 WIRING DEVICES
 - A. 120/277V WALL SWITCHES SHALL BE MOUNTED IN SUITABLE OUTLET BOXES IN THE WALL OR PARTITIONS, THEY SHALL BE OF THE AC QUIET DESIGN, TOGGLE HANDLE, 20 AMP RATED. THEY SHALL BE SPECIFICATION GRADE.
 - B. CONVENIENCE OUTLETS SHALL EACH BE SPECIFICATION GRADE, GROUNDING TYPE, THREE WIRE (TWO CIRCUIT WIRES PLUS EQUIPMENT GROUND) SINGLE OR DUPLEX AS INDICATED ON THE DRAWINGS, BOXES FOR 120 VOLTS, 20 AMP, FOR REGULAR OUTLET MOUNTING, AND WITH FACE SLOT CONFIGURATION MATCHING THE NEMA STANDARD FOR THE RATING AND WIRES.
 - C. STYLE AND COLOR OF WIRING DEVICES AND COVER PLATES SHALL BE SELECTED BY THE ARCHITECT.
 - D. ACCEPTABLE MANUFACTURERS: HUBBELL, LEVITON, PASLEGRAND, OR EATON.
 - 2.5 ELECTRICAL CONNECTIONS
 - A. ALL WIRE CONNECTIONS SHALL BE MADE BY MEANS OF SOLDERLESS CONNECTORS.
 - B. BRANCH CIRCUIT JOINTS OF SPLICES FOR WIRES #10 AND SMALLER SHALL BE MADE WITH 3M BRAND SCOTCHLOK ELECTRICAL SPRING CONNECTORS.
 - C. SPLICES AND JOINTS FOR CONDUCTORS NO. 8 AND LARGER SHALL BE BY MEANS OF HIGH PRESS, LONG BARREL, CAST COPPER, COMPRESSION CONNECTORS.
 - D. JOINT AND SPLICES SHALL BE COVERED WITH 3M ELECTRICAL TAPE TO 150% OF INSULATION VALUE.
 - E. NO SPLICES SHALL BE MADE IN THE CONDUCTOR EXCEPT AT OUTLET BOXES, JUNCTION BOXES, OR IN SPLICE BOXES.
 - 2.6 PANELBOARDS
 - A. EXISTING PANEL BOARDS TO BE REUSED SHALL BE PROVIDED WITH UPDATED TYPE WRITTEN DIRECTORIES. IF WORK IS COMPLETED, CONTRACTOR SHALL PROVIDE NEW CIRCUIT BREAKERS TO MATCH EXISTING PANEL BOARDS AS INDICATED ON DRAWINGS.
 - 2.7 DISCONNECT SWITCHES
 - A. PROVIDE HEAVY DUTY SURFACE-MOUNTED SAFETY SWITCHES FOR MOTORS UNLESS OTHERWISE INDICATED, OF TYPES, SIZES, AND ELECTRICAL CHARACTERISTICS AS INDICATED ON THE DRAWINGS AND SPECIFICATIONS. THE SWITCHES SHALL BE FUSED OR NON-FUSED AS INDICATED ON THE DRAWINGS OR AS REQUIRED AND SHALL BE MANUFACTURED BY SQUARE D, EATON, OR GENERAL ELECTRIC.
 - B. SWITCHES SHALL HAVE SWITCH BLADES WHICH SHALL BE FULLY VISIBLE IN THE OFF POSITION WHEN THE ENCLOSURE DOOR IS OPEN, CURRENT CARRYING PARTS SHALL BE PLATED COPPER AND SWITCH CONTACTS SHALL BE SILVER-TUNGSTEN. SWITCHES SHALL BE QUICK-MAKE, QUICK-BREAK TYPE. THE OPERATING HANDLE SHALL BE AN INTEGRAL PART OF THE ENCLOSURE BASE AND SHALL BE PADLOCKABLE IN THE OFF POSITION. THE HANDLE POSITION SHALL INDICATE WHETHER THE SWITCH IS ON OR OFF. SWITCHES SHALL BE NON-REPOWER RATED FOR 250 AC OR 100 OR 600 VOLTS AC AS REQUIRED.
 - C. CONTACTS: PROVIDE TWO FORM C AUXILIARY, 10 AMPERE, 300 VOLT RATED CONTACTS. THE CONTACTS SHALL PROVIDE FOR TWO NORMALLY OPEN AND TWO NORMALLY CLOSED CONTACTS FOR SWITCH OPEN OR CLOSED POSITION.

- 3.0 EXECUTION
 - 3.1 AS A MINIMUM, ELECTRICAL WORK SHALL COMPLY WITH NECA STANDARDS AND RECOMMENDED PRACTICES FOR ELECTRICAL INSTALLATION AS APPLICABLE TO THIS PROJECT, NECA PHONE 201-215-4504.
 - 3.2 THE CONTRACTOR SHALL MAKE POWER CONNECTIONS TO ALL MOTORS AND EQUIPMENT FURNISHED BY OTHERS. SEE ARCHITECTURAL AND MECHANICAL DRAWINGS, SPECIFICATIONS AND NOTES FOR ADDITIONAL INFORMATION.
 - 3.3 ALL CIRCUIT BREAKERS, FUSES AND ELECTRICAL EQUIPMENT SHALL HAVE AN INTERRUPTING RATING NOT LESS THAN THE MAXIMUM SHORT CIRCUIT CURRENT TO WHICH THEY MAY BE SUBJECT.
 - 3.4 ALL MATERIALS AND EQUIPMENT SHALL BE NEW AND SHALL BEAR THE UNDERWRITERS' LABEL (UL) AND SHALL BE INSTALLED IN THE MANNER FOR WHICH THEY ARE DESIGNED AND APPROVED.
 - 3.5 ALL DEVICES INSTALLED OUTSIDE OR IN DAMP LOCATIONS SHALL BE APPROVED WEATHERPROOF.
 - 3.6 THE CONTRACTOR SHALL INSTALL ALL CONDUITS AND WIRES WITH A MINIMUM NUMBER OF BENDS AND IN SUCH A MANNER AS TO CONFORM TO THE STRUCTURE, AVOID OBSTRUCTIONS, PRESERVE HEAD ROOM, KEEP OPENINGS AND PASSAGEWAYS CLEAR AND MEET ALL STRUCTURAL CODE REQUIREMENTS.
 - 3.7 THE CONTRACTOR SHALL NOT BORE, NOTCH OR IN ANY WAY CUT INTO ANY STRUCTURAL MEMBER WITHOUT WRITTEN APPROVAL FROM THE ARCHITECT OR STRUCTURAL ENGINEER.
 - 3.8 ALL CONDUIT CONNECTIONS TO MACHINES, MOTORS, AND EQUIPMENT SUBJECT TO VIBRATION (INCLUDING TRANSFORMERS) SHALL BE MADE WITH LIQUIDTIGHT FLEX CONDUIT. FLEXIBLE CONNECTION SHALL BE BETWEEN 18 AND 36 INCHES IN LENGTH, ARRANGE CONNECTIONS TO PREVENT THE ENTRANCE OF MOISTURE, PROVIDE CONTINUOUS ELECTRICAL GROUND WIRE THROUGH ALL FLEXIBLE CONDUITS TO ASSURE GROUND CONTINUITY.
 - 3.9 THE ENTIRE ELECTRICAL INSTALLATION SHALL BE GROUNDING AS REQUIRED BY ALL APPLICABLE CODES.
 - 3.10 THE ENTIRE WIRING SYSTEM SHALL BE TESTED FOR SHORT CIRCUITS, GROUNDING AND INSULATION RESISTANCE BETWEEN CONDUCTORS AND TO GROUND.
 - 3.11 THE CONTRACTOR SHALL FURNISH AND INSTALL ALL CONDUITS, WIRES, BOXES, SWITCHES, LIGHT FIXTURES (WITH LAMPS), RECEPTACLES, SERVICE DEVICES, SWITCHBOARDS AND PANELBOARDS REQUIRED FOR A COMPLETE AND OPERATIONAL ELECTRICAL SYSTEM.
 - 3.12 PROVIDE EXTERNAL MANUAL DISCONNECTING MEANS AT ALL MOTORS OR PACKAGED MECHANICAL EQUIPMENT UNLESS NOTED OTHERWISE.
 - 3.13 PROVIDE AN ENCLOSURE OF EQUAL FIRE RESISTANT RATING AROUND ALL FIXTURES AND EQUIPMENT INSTALLED IN OR PENETRATING THROUGH FIRE RATED SEPARATIONS, THROUGH STOP FIRE SEALING OF CONDUITS SHALL BE MADE WITH 3M CP25P+ CALK ACCORDING TO UL APPLICATION.
 - 3.14 LOCATIONS SHOWN ON THE ARCHITECTURAL AND MECHANICAL DRAWINGS TAKE PRECEDENCE OVER THOSE SHOWN ON THE ELECTRICAL DRAWINGS. REFER TO THE MECHANICAL, PLUMBING AND HEAT/AC DRAWINGS FOR THE EXACT LOCATIONS, RATINGS, TYPE CONNECTIONS, WIRING DIAGRAMS AND AUXILIARY DEVICES.
 - 3.15 THE CONTRACTOR SHALL FURNISH AND INSTALL CONDUIT, WIRE AND CONNECTIONS FOR LINE VOLTAGE LIGHTING CONTROLS AND LOW VOLTAGE LIGHTING CONTROL UNLESS NOTED OTHERWISE ON DRAWINGS. THE CONTRACTOR SHALL MAKE ALL POWER CONNECTIONS ALL TO AC EQUIPMENT INCLUDING 120 VOLT POWER CONTROL, MONITORING, AND SIGNALING EQUIPMENT FURNISHED BY OTHER DISCIPLINES. COORDINATE WITH OTHER DISCIPLINES FOR REQUIREMENTS.
 - 3.16 THE CONTRACTOR SHALL RECEIVE, STORE AND INSTALL ALL ELECTRICAL ITEMS FURNISHED BY THE OWNER.
 - 3.17 REFER TO THE REFLECTED CEILING PLAN AND THE ARCHITECTURAL FLOOR PLANS FOR THE EXACT LOCATIONS OF ALL LIGHTING FIXTURES AND DEVICES.
 - 3.18 PROVIDE TYPEWRITTEN DIRECTORY CARD IN ALL NEW AND MODIFIED PANELS, IDENTIFY LOAD SERVED BY EACH CIRCUIT BREAKER.
 - 3.19 PROVIDE ENGRAVED NAMEPLATES ON ALL PANEL(S), TRANSFORMERS, DISCONNECT SWITCHES, AND SWITCHBOARDS.
 - 3.20 RECEPTACLES SHALL HAVE PRINTED LABELS WITH THE PANEL AND CIRCUIT NUMBER PLACED ON THE COVER. THE LABEL SHALL BE RED WITH WHITE LETTERS FOR EMERGENCY RECEPTACLES AND BLACK WITH WHITE LETTERS FOR NORMAL RECEPTACLES.
 - 3.21 THE CONTRACTOR SHALL PROVIDE A SET OF AS-BUILT DRAWINGS SHOWING THE LOCATIONS AND DEPTHS OF ALL UNDERGROUND CONDUITS, INDICATE ALL CHANGES MADE DURING CONSTRUCTION, AND ANY DEVIATIONS FROM THE ELECTRICAL DRAWINGS.
 - 3.22 PROVIDE PULL WIRE IN ALL EMPTY CONDUITS.
 - 3.23 FOR PURPOSES OF CLEARNESS AND LEGIBILITY, THE ELECTRICAL DRAWINGS ARE ESSENTIALLY DIAGRAMMATIC. THE SIZE AND LOCATION OF EQUIPMENT IS SHOWN TO SCALE WHEREVER POSSIBLE. THE CONTRACTOR SHALL VERIFY ALL CONDITIONS AND INFORMATION AS INDICATED ON THE DRAWINGS AND IN THE SPECIFICATION SECTIONS WHERE ELECTRICAL WORK INTERFACES WITH OTHER TRADES.
 - 3.24 DISCONNECT AND REMOVE ALL EXISTING INTERIOR AND EXTERIOR ELECTRICAL DEVICES, EQUIPMENT, WIRING, EXPOSED ABANDONED CONDUIT, ETC., NO LONGER REQUIRED UNLESS OTHERWISE NOTED.
 - 3.25 CONTRACTORS SHALL VISIT THE EXISTING BUILDINGS AND GROUNDS AND FAMILIARIZE THEMSELVES WITH EXISTING CONDITIONS. NO ALLOWANCE WILL BE MADE SUBSEQUENTLY, ON THIS CONDITION, IN BEHALF OF THE CONTRACTORS FOR ANY ERROR OR NEGLIGENCE ON THEIR PART.
 - 3.26 WHERE EXISTING EQUIPMENT OR CONDUIT IS REMOVED OR CHANGED, ALL CONDUIT AND WIRE NO LONGER IN SERVICE SHALL BE REMOVED AS DIRECTED BY THE ARCHITECT. ALL BUILDING SURFACES DAMAGED AND OPENINGS LEFT BY THE REMOVAL OR RELOCATION OF EQUIPMENT, CONDUIT, ETC., SHALL BE REPAIRED BY THIS CONTRACTOR.
 - 3.27 EXISTING CONDUIT AND WIRE SHALL NOT BE REUSED IF MOVED FROM THEIR PRESENT LOCATION OR IF IT IS OF INADEQUATE CAPACITY FOR THE NEW LOAD.
 - 3.28 ALL CONDUIT SHALL BE CONCEALED WHEREVER POSSIBLE. THE CONTRACTOR SHALL REVIEW THE PLANS AND SPECIFICATIONS TO DETERMINE WHERE NEW WALLS AND CEILING ARE TO BE INSTALLED AND SHALL MAKE USE OF THESE AREAS TO CONCEAL CONDUIT. THE CONTRACTOR SHALL USE SURFACE RACEWAYS SUCH AS WIREMOLD WHERE NECESSARY, OR AS DIRECTED.

- GENERAL NOTES FOR DEMOLITION
 1. EXAMINATION
 - A. THE CONTRACTOR SHALL VISIT THE SITE AND EXAMINE AREAS UNDER WHICH THE WORK IS TO BE PERFORMED AND NOTIFY THE OWNER IN WRITING OF ANY CONDITIONS DETRIMENTAL TO THE PROPER AND TIMELY COMPLETION OF THE WORK. CONTRACTOR SHALL NOT PROCEED WITH WORK UNTIL SATISFACTORY CONDITIONS HAVE BEEN CORRECTED.
 - B. VERIFY FIELD MEASUREMENTS AND CIRCUITING ARRANGEMENTS FOR DEVICES SHOWN ON DRAWINGS.
 - C. DEMOLITION DRAWINGS ARE BASED ON CASUAL FIELD OBSERVATION AND EXISTING RECORD DRAWINGS. REPORT DISCREPANCIES TO OWNER BEFORE DISTURBING EXISTING INSTALLATION.
 - D. COMMENCEMENT OF DEMOLITION MEANS ACCEPTANCE OF EXISTING CONDITIONS.
 2. PREPARATION
 - A. DISCONNECT ELECTRICAL SYSTEMS IN WALLS, FLOORS, AND CEILING SCHEDULED FOR REMOVAL.
 - B. COORDINATE UTILITY SERVICE SHUT-DOWN WITH THE UTILITY COMPANY.
 - C. NOTIFY THE OWNER AT LEAST 48 HOURS BEFORE PARTIALLY OR COMPLETELY DISABLING ANY ELECTRICAL SYSTEM.
 - D. PROVIDE TEMPORARY WIRING AND CONNECTIONS TO MAINTAIN EXISTING SYSTEM IN SERVICE DURING CONSTRUCTION. EXPERIENCED PERSONNEL SHALL BE USED WHEN WORKING ON ENERGIZED EQUIPMENT OR CIRCUITS.
 - E. EXISTING ELECTRICAL SERVICE: MAINTAIN EXISTING ELECTRICAL SYSTEM IN SERVICE UNTIL NEW SERVICE IS COMPLETE AND READY FOR SERVICE. DISABLE ELECTRICAL SYSTEM ONLY TO MAKE SWITCHOVERS AND CONNECTIONS. MINIMIZE OUTAGE DURATION. MAKE TEMPORARY CONNECTIONS TO MAINTAIN ELECTRICAL SERVICE IN AREAS ADJACENT TO WORK AREA.
 - F. MAINTAIN EXISTING FIRE ALARM SYSTEM IN SERVICE UNTIL NEW SYSTEM IS ACCEPTED. DISABLE SYSTEM ONLY TO MAKE SWITCHOVERS AND CONNECTIONS. WHERE FIRE ALARM DEVICES MUST BE REMOVED TO ACCOMMODATE THE REMOVAL OF WALLS, NOTIFY THE OWNER AND ENGINEER IN WRITING WITH LOCATIONS OF DEVICES.
 3. DEMOLITION AND EXTENSION OF EXISTING ELECTRICAL WORK.
 - A. REMOVE, RELOCATE, AND EXTEND EXISTING ELECTRICAL WORK AS INDICATED ON THE DRAWINGS AND AS NOTED HEREIN.
 - B. REMOVE ABANDONED WIRING BACK TO SOURCE OF SUPPLY.
 - C. WHERE SOURCE OF SUPPLY IS A PANELBOARD, RE-LABEL PROTECTIVE DEVICE AS "SPARE" AFTER DEMOLITION IS COMPLETE. SUBMIT REVISED PANELBOARD SCHEDULES INDICATING "SPARES" TO OWNER AND ENGINEER.
 - D. REMOVE EXPOSED ABANDONED CONDUIT ABOVE ACCESSIBLE CEILING FINISHES. CUT CONDUIT FLUSH WITH WALLS AND FLOORS, AND PATCH SURFACES.
 - E. DISCONNECT AND REMOVE ABANDONED OUTLETS AND ASSOCIATED DEVICES.
 - F. DISCONNECT AND REMOVE ABANDONED PANELBOARDS AND DISTRIBUTION EQUIPMENT.
 - G. DISCONNECT AND REMOVE ELECTRICAL DEVICES AND EQUIPMENT THAT IS NO LONGER IN USE.
 - H. DISCONNECT AND REMOVE ABANDONED LUMINAIRES, REMOVE BRACKETS, STEMS, HANGERS, AND ALL OTHER ACCESSORIES.
 - I. REPAIR ADJACENT CONSTRUCTION AND FINISHES DAMAGED DURING DEMOLITION AND EXTENSION OF WORK.
 4. CLEANING, REPAIR, AND REPLACEMENT
 - A. GENERAL: CLEAN AND REPAIR EXISTING MATERIALS AND EQUIPMENT THAT WILL REMAIN OR ARE TO BE REUSED.
 - B. PANELBOARDS: CLEAN EXPOSED SURFACES AND TIGHTEN ALL ELECTRICAL CONNECTIONS. REPLACE DAMAGED CIRCUIT BREAKERS AND PROVIDE CLOSURE PLATES FOR VACANT POSITIONS. PROVIDE TYPED SCHEDULES SHOWING REVISED CIRCUITING INFORMATION.
 - C. LUMINAIRES: REMOVE EXISTING LUMINAIRES FOR CLEANING. USE MILD DETERGENT TO CLEAN EXTERIOR AND INTERIOR SURFACES. RINSE CLEAN WITH CLEAN WATER AND WIPE DRY. REPLACE EXISTING LAMPS AND BALLASTS WITH NEW.
 5. DISPOSAL
 - A. OWNER SHALL HAVE RIGHT TO RETAIN ANY EQUIPMENT OR MATERIALS THAT HAVE BEEN DEMOLISHED PRIOR TO DISPOSAL OR REMOVAL FROM SITE.
 - B. ANY EQUIPMENT OR MATERIALS NOT WANTED BY THE OWNER SHALL BECOME THE PROPERTY OF THE CONTRACTOR AND REMOVED FROM SITE.
 - C. CONTRACTOR SHALL COMPLY WITH ENVIRONMENTAL LAWS AND REGULATIONS FOR DISPOSAL OF DEMOLISHED MATERIALS AND EQUIPMENT.

- ELECTRICAL GENERAL NOTES
 1. CODES
 - A. THE WORK SHALL COMPLY WITH ALL APPLICABLE LOCAL, MUNICIPAL, AND NATIONAL CODES, WHERE THE CONSTRUCTION DOCUMENTS INDICATE MORE RESTRICTIVE REQUIREMENTS THE CONSTRUCTION DOCUMENTS SHALL GOVERN. HOWEVER, THE CONSTRUCTION DOCUMENTS SHALL NOT BE INTERPRETED AS AUTHORITY TO VIOLATE ANY CODE OR REGULATION.
 2. DRAWINGS AND SPECIFICATIONS
 - A. THE CONTRACTOR SHALL BE RESPONSIBLE FOR READING AND COMPLYING WITH BOTH THE DRAWINGS AND SPECIFICATIONS, IN THE EVENT OF A CONFLICT OR INCONSISTENCY BETWEEN THE DRAWINGS, NOTES, SPECIFICATIONS, OR CODES, THE REFERENCE WHICH PROVIDES THE MORE COMPLETE OR HIGHER STANDARD SHALL PREVAIL.
 3. INTERPRETATION OF THE DOCUMENTS
 - A. CAREFULLY COMPARE THE DRAWINGS AND SPECIFICATIONS, CHECKING MEASUREMENTS AND CONDITIONS UNDER WHICH THIS INSTALLATION IS TO BE MADE. FOR CLARIFICATION BETWEEN VARIOUS DRAWINGS, BETWEEN DRAWINGS OR SPECIFICATION, OR BETWEEN SECTIONS OF THE SPECIFICATION, THE MATTER SHALL BE REFERRED TO THE ENGINEER BEFORE ANY WORK IS EXECUTED. THE CONTRACTOR SHALL STATE IN THEIR PROPOSAL ANY EXCEPTIONS NECESSARY TO MAKE THIS A COMPLETE, READY TO USE INSTALLATION. IF NOT STATED IN THE PROPOSAL, IT WILL NOT BE CONSIDERED EXTRA.
 4. ELECTRICAL DRAWINGS
 - A. THE ELECTRICAL DRAWINGS ARE DIAGRAMMATIC AND SHALL NOT BE SCALED. THE CONTRACTOR SHALL DETERMINE THE EXACT LOCATION OF ALL DOORS, WALLS, FURNITURE, EQUIPMENT, ETC. THE LOCATION OF RACEWAY SYSTEM COMPONENTS IS SCHEMATIC. THE EXACT LOCATION OF RACEWAY SYSTEM COMPONENTS SHALL BE DETERMINED BY THE CONTRACTOR IN THE FIELD. THE CONTRACTOR SHALL CONFIRM THE DIMENSIONS OF THE ACTUAL EQUIPMENT TO BE SUPPLIED FOR THIS PROJECT, AND VERIFY CLEARANCES AND ROUGH-IN'S PRIOR TO STARTING WORK.
 5. SITE EXAMINATION
 - A. BEFORE SUBMITTING A BID, THE CONTRACTOR SHALL VISIT THE SITE, EXAMINE THE PREMISES, AND MAKE A THOROUGH SURVEY OF THE EXISTING CONDITIONS. THE SUBMISSION OF A PROPOSAL WILL BE CONSTRUED AS EVIDENCE THAT SUCH AN EXAMINATION HAS BEEN MADE. NO CONSIDERATION OR ALLOWANCE WILL BE GRANTED FOR FAILURE TO VISIT THE SITE OR FOR LATER CLAIMS FOR LABOR, EQUIPMENT, MATERIALS REQUIRED, OR FOR DIFFICULTIES ENCOUNTERED WHICH COULD HAVE BEEN FORESEEN HAD SUCH AN SITE EXAMINATION BEEN MADE.
 6. COORDINATION WITH OTHER TRADES
 - A. THE ELECTRICAL CONTRACTOR SHALL OBTAIN A COMPLETE SET OF ARCHITECTURAL AND ENGINEERING DOCUMENTS AND COORDINATE WITH MECHANICAL, PLUMBING, ARCHITECTURAL, AND OTHER TRADES FOR EXACT DIMENSIONS, CLEARANCES, ROUGH-IN LOCATIONS, AND OTHER ADDITIONAL SCOPE OF WORK THAT MAY NOT BE SHOWN ON THE ELECTRICAL PLANS. THE ELECTRICAL CONTRACTOR SHALL BE RESPONSIBLE FOR ALL 120 VOLT (AND HIGHER) AC POWER TO OTHER TRADES EQUIPMENT AND HARDWARE. THIS SHALL INCLUDE, BUT NOT BE LIMITED TO, CONTROLS, FIRE AND SECURITY SYSTEMS, MOTORIZED DOORS, DAMPERS, LAMPS, AND OTHER SYSTEMS, UNLESS SPECIFICALLY NOTED OTHERWISE ON THE ELECTRICAL PLANS. THE ELECTRICAL CONTRACTOR SHALL FURNISH ALL SAFETY DISCONNECT SWITCHES TO MECHANICAL EQUIPMENT.
 7. PERMITS, APPLICATIONS AND RELEASES
 - A. THE CONTRACTOR SHALL OBTAIN AND PAY FOR ALL PERMITS, INSPECTIONS, APPLICATIONS, RELEASES AND FEES REQUIRED BY LOCAL, STATE AND FEDERAL AGENCIES FOR THE EXECUTION OF THIS WORK. SCHEDULING OF ALL REQUIRED INSPECTIONS SHALL BE THE RESPONSIBILITY OF THE CONTRACTOR.
 8. FIRE STOPPING
 - A. ALL PENETRATIONS IN WALL, FLOOR OR CEILING SHALL BE SUITABLY CLOSED UP AND SEALED WITH AN INTUMESCENT FIRE STOPPING COMPOUND LISTED IN THE MOST RECENT FACTORY MUTUAL RESEARCH CORPORATION (FMRC) APPROVAL GUIDE. FIRE STOPPING PRODUCTS SHALL BE MANUFACTURED BY 3M COMPANY OR APPROVED EQUAL.
 9. ELECTRICAL SERVICE DISRUPTIONS
 - A. ALL WORK WHICH EXPOSES ACTIVE BUS REQUIRES A WRITTEN NOTIFICATION TO THE OWNER WHICH WILL OUTLINE THE METHOD OF PROCEDURE FOR THE WORK. THE CONTRACTOR SHALL PROVIDE A MINIMUM OF 5 DAYS NOTICE TO THE OWNER BEFORE WORKING ON ANY ENERGIZED ELECTRICAL SYSTEM. ALL POWER DISRUPTION SHALL OCCUR AT TIMES AND OF DURATIONS ACCEPTABLE TO THE OWNER.
 10. EQUIPMENT
 - A. ALL MATERIALS AND EQUIPMENT USED IN THIS INSTALLATION SHALL BE NEW, AND HAVE THE APPROPRIATE UL LISTING AND LABEL.

11. MISCELLANEOUS SUPPORTING MEMBERS
 - A. ALL ANGLES CHANNELS, AND OTHER MISCELLANEOUS STEEL, BOLTS, RODS, ETC. REQUIRED TO SUPPORT LIGHT FIXTURE, CONDUIT, RACEWAY, LADDER TRAY, OR OTHER ELECTRICAL EQUIPMENT OR DEVICES SHALL BE FURNISHED AND INSTALLED BY THE CONTRACTOR.
12. PANELBOARDS
 - A. ALL PANELBOARDS SHALL BE PROVIDED WITH TYPEWRITTEN DIRECTORIES. SEE PANEL SCHEDULES ON THE DRAWINGS AND SPECIFICATIONS FOR COMPLETE IDENTIFICATION AND LABELING REQUIREMENTS.
13. SAFETY
 - A. THE CONTRACTOR SHALL TAKE ALL STEPS NECESSARY TO ENSURE THE SAFETY OF THE OWNERS EMPLOYEES, BUILDING EMPLOYEES AND GUESTS, AS WELL AS THEIR OWN FORCES, BY ADEQUATELY PROTECTING ANY EXPOSED LIVE CONDUCTORS, OR DEVICES THROUGHOUT THE COURSE OF THIS WORK.
 - A. COMPLY WITH NFPA 241 FOR SAFEGUARDING DURING CONSTRUCTION AND ALTERATION OPERATIONS. IN ADDITION, ANY OPENINGS IN FIRE RATED SEPARATIONS BETWEEN OCCUPIED AND UNOCCUPIED (OR OPERATIONAL AND NON-OPERATIONAL) AREAS SHALL BE SEALED AT THE END OF EACH WORK DAY WITH AN APPROPRIATE FIRE RATED ENCLOSURE OR SEALANT. DO NOT COMPROMISE EXISTING SECURITY OR FIRE ALARM SYSTEMS SERVING THE OCCUPIED OR OPERATIONAL AREAS.
14. EQUIPMENT CONNECTIONS
 - A. PROVIDE FINAL ELECTRICAL CONNECTIONS TO ALL EQUIPMENT FURNISHED UNDER OTHER TRADES AND FOR ALL OWNER FURNISHED EQUIPMENT. PROVIDE A FLEXIBLE LIQUID TIGHT CONNECTION TO ALL VIBRATION PRODUCING EQUIPMENT.
15. INTERFERENCE WITH OCCUPANCY
 - A. THE PRESENT BUILDING IS OCCUPIED AND WILL CONTINUE TO BE DURING THE PROGRESS OF THIS WORK. IT IS IMPERATIVE, THEREFORE, THAT THE WORK COVERED BY THESE DOCUMENTS BE EXECUTED WITH A MINIMUM OF INCONVENIENCE TO THE BUILDING PERSONNEL, AND OTHER TENANTS.
16. TEMPORARY REQUIREMENTS
 - A. PROVIDE TEMPORARY LIGHTING, POWER, AND FIRE ALARM COMPONENTS AS REQUIRED IN AREAS UNDERGOING WORK DURING CONSTRUCTION.
 - A. FURNISH AND INSTALL AN APPROVED TEMPORARY FIRE ALARM SYSTEM AS REQUIRED BY LOCAL CODES AND AUTHORITY HAVING JURISDICTION.
 - A. ALL TEMPORARY ELECTRICAL EQUIPMENT SHALL BE REMOVED BEFORE THE AREA CEILING ARE INSTALLED.
17. CABLING
 - A. BRANCH CIRCUITS TO RECEPTACLES, LIGHTING AND MISC. SMALL LOADS (15 OR 20 AMP CIRCUITS), UNLESS SPECIFICALLY NOTED OTHERWISE, SHALL BE 2#12, 1#12G, -3#4" C. SEE NOTE BELOW FOR ADDITIONAL REQUIREMENTS. MINIMUM SIZE WIRE SHALL BE #12 AWG AND MINIMUM SIZE CONDUIT SHALL BE 3/4" TRADE SIZE.
18. CABLING SIZES
 - A. BRANCH CIRCUIT CABLE SIZING SHALL BE BASED ON THE VALUES INDICATED BELOW:
 - A. 120/208V CABLING FROM PANEL TO THE ELECTRICAL LOAD SHALL BE ADJUSTED AS FOLLOWS UNLESS SPECIFICALLY NOTED OTHERWISE:

0 - 100 #12 AWG MINIMUM
100 - 200 #10 AWG MINIMUM
200 - 250 #8 AWG MINIMUM
 - B. 277/480V CABLING FROM PANEL TO THE ELECTRICAL LOAD SHALL BE ADJUSTED AS FOLLOWS UNLESS SPECIFICALLY NOTED OTHERWISE:

0 - 150 #12 AWG MINIMUM
150 - 250 #10 AWG MINIMUM
250 - 300 #8 AWG MINIMUM
19. SPECIAL LUG REQUIREMENTS
 - A. ANY CABLE WHICH TERMINATES DIRECTLY ON TO A BUS BAR SHALL BE 2 BOLT LONG BARREL TYPE WITH INSPECTION HOLES PRODUCED WITH NON FLASHING TYPE DYES AS MANUFACTURED BY THOMAS AND BETTS OR APPROVED EQUAL. MINIMUM 10 TONS OF COMPRESSION, HEX CRIMP. THE USE OF HEAT SHRINK TUBING IS EXPLICITLY FORBIDDEN. THERE SHALL BE NO "SHIMERS" AT THE LUGS.

ELECTRICAL CONTRACTOR SHALL APPROVE ALL PANELS REFERRED TO ON THESE DRAWINGS, AFTER DEMOLITION OF ALL EQUIPMENT. REPORT ALL FINDINGS TO THE ENGINEER, IN WRITING, BEFORE PROCEEDING WITH ANY NEW CONNECTIONS.

DESIGNATION	DESCRIPTION
	DUPLEX RECEPTACLE (WALL MOUNTED) +18" AFF UO
	DISCONNECT SWITCH (NON-FUSED)
	SWITCH
	EQUIPMENT TAG SEE EQUIPMENT SCHEDULE
	FLEXIBLE CONDUIT
	BRANCH CIRCUIT PANELBOARD
	TRANSFORMER THKVA
	MOTOR MHP
	MOTOR CONTROL CENTER
	EMERGENCY POWER OFF STATION (PLAN SYMBOL)
	EMERGENCY POWER OFF PUSHBUTTON (WIRING DIAGRAM SYMBOL)
	CONTRACTOR COOL (WIRING DIAGRAM SYMBOL)
	FORM "A" (NORMALLY OPEN) CONTACT (WIRING DIAGRAM SYMBOL)

ELECTRICAL ABBREVIATIONS			
AC	ALTERNATING CURRENT	MCB	MAIN CIRCUIT BREAKER
AF	AMPERE FRAME, AMPERE FUSE	MCC	MOTOR CONTROL CENTER
AMP	AMPERE	MLO	MAN LUGS ONLY
AMP	AMPERE	MN	MINIMUM
AT	AMPERE TRIP	N/A	NOT APPLICABLE
ATS	AUTOMATIC TRANSFER SWITCH	NATS	NON-AUTOMATIC TRANSFER SWITCH
AWG	AMERICAN WIRING GAUGE	NC	NORMALLY CLOSED
BP	BRANCH CIRCUIT PANEL	NEC	NATIONAL ELECTRIC CODE
BKR	BREAKER	NEMA	NATIONAL ELECTRICAL MANUFACTURERS ASSOCIATION
C	CONDUIT	NETA	NATIONAL ELECTRICAL TESTING ASSOCIATION
CATV	CABLE ACCESSED TELEVISION	NF	NORMALLY OPEN
CB	CIRCUIT BREAKER	NO	NORMALLY OPEN
CT	CURRENT TRANSFORMER	OC	OVER CURRENT
CU	COPPER	OSHA	OCCUPATIONAL SAFETY AND HEALTH ADMINISTRATION
DC	DIRECT CURRENT	P	POLE
DISC	DISCONNECT	PB	PULL BOX
DNW	DOWN DRAWING	PDU	POWER DISTRIBUTION UNIT
EM	EMERGENCY	PE	PROFESSIONAL ENGINEER
EM	ELECTROMAGNETIC INTERFERENCE	PF	POWER FACTOR
EMT	ELECTRIC METALLIC TUBING	PH	PHASE
EPO	EMERGENCY POWER OFF	PM	POWER MONITORING DEVICE
E	EXISTING	PNL	PANELBOARD
F	FUSE	PP	POWER PANEL
FA	FIRE ALARM	PT	POTENTIAL TRANSFORMER
FAFP	FIRE ALARM ANNUNCIATOR PANEL	PVC	POLYVINYL CHLORIDE
FACP	FIRE ALARM CONTROL PANEL	RFI	RADIO FREQUENCY INTERFERENCE
FLA	FULL LOAD AMPERES	RGS	RIGID GALVANIZED STEEL CONDUIT
FLR	FLOOR MEAN SQUARE RECEPTACLE PANEL	RMC	RIGID METAL CONDUIT
FMC	FLEXIBLE METAL CONDUIT	RMS	ROOT MEAN SQUARE
GEN	GENERATOR	RFP	RECEPTACLE PANEL
GF	GROUND FAULT	SCA	SHORT CIRCUIT AMPERES
GFCI	GROUND FAULT CIRCUIT INTERRUPTER	SWB	SWITCHBOARD
G	GROUND	T	TELEPHONE
HID	HIGH INTENSITY DISCHARGE	THD	TOTAL HARMONIC DISTORTION
HDA	HAND OFF AUTO	TIA	TELECOMMUNICATIONS INDUSTRY ASSOCIATION
HFS	HIGH PRESSURE SODIUM	HF	HIGH FREQUENCY
HPS	HERTZ (CYCLE)	TV	TELEVISION
IC	INTERRUPTING CAPACITY	TVSS	TRANSIENT VOLTAGE SURGE SUPPRESSION
IEEE	INSTITUTE OF ELECTRICAL AND ELECTRONICS ENGINEERS	UH	UNIT HEATER
IG	INTERMEDIATE METAL CONDUIT	UL	UNDERWRITERS LABORATORIES
IMC	INTERMEDIATE METAL CONDUIT	UNO	UNLESS NOTED OTHERWISE
JB	JUNCTION BOX	UPS	UNINTERRUPTIBLE POWER SUPPLY
KV	KILOVOLT	V	VOLTAGE
KVA	KILOVOLT-AMPERE	VA	VOLT-AMPERE
KW	KILOWATT	VFD	VARIABLE FREQUENCY DRIVE
LPS	LOW PRESSURE SODIUM	VM	VOLT METER
LPA	LIGHTING PANEL	W	WATT
LPR	LOCKED ROTOR AMPERES	WP	WEATHERPROOF
LRT	LIGHTING RELAY PANEL	WM	WATT METER
L	LIGHTING	XPFR	TRANSFORMER

ELECTRICAL SPECIFICATIONS, NOTES, ABBREVIATIONS, AND SYMBOLS
EVANSTON PUBLIC LIBRARY BOILER REPLACEMENT
1703 ORRINGTON, EVANSTON IL

ISSUES & REVISIONS		
NO.	DESCRIPTION	DATE
OWNER REVIEW		03/05/2013
ISSUED FOR BID/PERMIT		03/17/2013

SCALE		
NO SCALE		

DRAWN	CHECKED	APPROVED
WJN	JEM	JET

PROJECT NO. P22-1142-00

E001



Grumman/Butkus Associates
 Energy Efficiency Consulting and Sustainable Design Engineers
 820 Davis St, Ste 300
 Evanston, Illinois 60201 4446
 847.328.3555 grummanbutkus.com

CONSULTANTS

SEAL

ELECTRICAL SCHEDULES AND DETAILS

EVANSTON PUBLIC LIBRARY BOILER REPLACEMENT
 1703 ORRINGTON, EVANSTON IL

ISSUES & REVISIONS		
NO.	DESCRIPTION	DATE
OWNER REVIEW		03/05/2023
ISSUED FOR BIDDING		03/17/2023

REVISED

SCALE
 NO SCALE

DRAWN	CHECKED	APPROVED
WJN	JEM	JET

PROJECT NO. P22-1142-00

E002

- ### GENERAL NOTES
- REFER TO E-001 FOR ELECTRICAL SPECIFICATIONS, NOTES, ABBREVIATIONS AND SYMBOLS.
 - REFER TO MECHANICAL PLANS FOR CONSTRUCTION SCOPE OF WORK. CONTRACTOR TO FIELD VERIFY CONSTRUCTION SCOPE OF WORK PRIOR TO COMMENCING WORK.
 - REFER TO MECHANICAL DRAWINGS FOR THE EXACT LOCATION OF ALL NEW MECHANICAL EQUIPMENT.
 - CONTRACTOR TO COORDINATE EQUIPMENT AND DEVICE LOCATIONS WITH MECHANICAL DRAWINGS AND OTHER TRADES PRIOR TO ROUGH-IN.
 - NOT ALL EXISTING DEVICES ARE NOTED ON THE DRAWINGS. UNLESS OTHERWISE NOTED, ALL ELECTRICAL DEVICES ARE EXISTING TO REMAIN. PROTECT EXISTING TO REMAIN DEVICES DURING CONSTRUCTION.
 - CONTRACTOR TO PROVIDE ALL HARDWARE, ACCESSORIES, PROGRAMMING, AND CONFIGURATION REQUIRED FOR A COMPLETE INSTALLATION.
 - PROVIDE SEPARATE NEUTRALS FOR ALL CIRCUITS.
 - EXISTING CONDUIT FOR DEMOLISHED DEVICES MAY BE REUSED FOR NEW WORK IF ADEQUATE FOR NEW INSTALLATION. CONTRACTOR SHALL PROVIDE NEW WIRING FOR NEW DEVICES.

- ### CONSTRUCTION PLAN NOTES
- CONNECT NEW BOILERS IN SPACES MADE AVAILABLE BY DEMOLITION OF EXISTING BOILERS. REFER TO NOTES AT BOTTOM OF MCC SCHEDULE.
 - MADE SPARE AFTER DEMOLITION OF AH-1.
 - PROVIDE NEW PANEL IN PLACE OF EXISTING PANEL.

- ### EMERGENCY POWER OFF NOTES
- EMERGENCY POWER OFF (EPO) PUSH BUTTON - REUSE EXISTING EPO PUSH BUTTON IF ADEQUATE FOR REUSE. PROVIDE ADDITIONAL 120V, 1-POLE EPO SWITCH WITH RED MUSHROOM PUSH BUTTON AND CLEAR PLASTIC HOUSING. MANUAL ACTUATION OF EITHER BUTTON SHALL OPEN NORMALLY CLOSED EPO SWITCH CONTACTS. DEENERGIZING BOILER CONTACTORS WHEN ACTIVATED. BUTTON COVER SHALL PROVIDE LOCAL AUDIBLE ALARM UPON LIFTING OF COVER. PUSH BUTTON SHALL HAVE MANUAL TURN-TO-RESET SWITCH CONFIGURATION. PROVIDE WITH LABEL THAT READS "BOILER EMERGENCY OFF" ON HOUSING. MOUNT BUTTON AT 42" AFF. BUTTON SHALL BE STI 8852G-88-2ZEN OR APPROVED EQUAL. REFER FLOOR PLANS FOR EPO PUSH BUTTON LOCATIONS. BUTTONS SHALL BE WIRED IN SERIES WITH EACH OTHER.
 - BOILER CONTACTORS - REUSE EXISTING CONTACTORS AND ENCLOSURE IF ADEQUATE FOR REUSE. IF NEW CONTACTORS ARE REQUIRED, PROVIDE 3-POLE CONTACTORS WITH 120V COIL AND 480V FORM-A CONTACTS. CONTACTS SHALL BE RATED TO CARRY AND INTERRUPT 480V, 12A INDUCTIVE LOAD. COIL AND CONTACTS SHALL BE RATED FOR CONTINUOUS USE. COIL SHALL BE ENERGIZED DURING NORMAL OPERATION OF BOILER. ACTIVATION OF EITHER EPO PUSH BUTTON SHALL DEENERGIZE CONTACTOR, CAUSING DISCONNECTION OF POWER TO BOILER. CONTACTOR SHALL BE INSTALLED IN NEMA 1 ENCLOSURE WITH LABEL IDENTIFYING BOILER SERVED, SOURCE PANELS, AND CIRCUIT NUMBERS FOR COIL AND CONTACT. BOILER CONTACTORS SHALL BE WIRED IN PARALLEL WITH EACH OTHER.
 - WIRING FOR EPO PUSH-BUTTON AND BOILER CONTACTOR COIL CIRCUIT SHALL BE 2#12, 1#12G, IN 3/4" C.
 - REFER TO ELECTRICAL EQUIPMENT SCHEDULE AND PANEL SCHEDULES FOR BOILER CONNECTION INFORMATION.

ELECTRICAL CONTRACTOR SHALL AMPROBE ALL PANELS REFERRED TO ON THESE DRAWINGS. AFTER DEMOLITION OF ALL EQUIPMENT, REPORT ALL FINDINGS TO THE ENGINEER, BEFORE PROCEEDING WITH ANY NEW CONNECTIONS.

MOTOR CONTROL CENTER: 4-MCC-1

CCT NO.	DESCRIPTION	LOAD				STARTER		SWITCH		NO. SPACES	REMARKS		
		CAPACITY (KW)	MOTOR RATED POWER (HP)	FULL LOAD (AMPS)	CONN. (KVA)	DEMAND (AMPS)	DEMAND (KVA)	FUSE SIZE (AMPS)	SWITCH SIZE (AMPS-POLES)			FUSE SIZE (AMPS)	
1A	MAIN LUGS	-	-	-	-	-	-	-	-	1	-		
1B	P-3	-	30.00	40.00	33.20	28.22	34.00	3	50	60	-	3#6, 1#10G, 1"C	
1C	P-1	-	20.00	27.00	22.41	19.05	22.95	2	30	30	-	3#10, 1#10G, 3/4"C	
1D	P-2	-	20.00	27.00	22.41	19.05	22.95	2	30	30	-	3#10, 1#10G, 3/4"C	
1E	SPARE	-	-	-	-	-	-	-	-	30	-	2	
1F	SPARE	-	-	-	-	-	-	-	-	30	-	2	
2A	B-1	-	-	12.00	9.96	8.47	10.20	-	-	30	15	2	3#12, 1#12G, 3/4"C
2B	B-2	-	-	12.00	9.96	8.47	10.20	-	-	30	15	2	3#12, 1#12G, 3/4"C
2C	P-5	-	0.50	1.00	0.83	0.71	0.85	1	1.25	30	-	2	3#12, 1#12G, 3/4"C
2D	SPARE	-	-	-	-	-	-	1	2.25	30	-	2	-
2E	UNLABELED	-	-	-	-	-	-	-	-	30	-	2	-
2F	P-6	-	0.50	1.00	0.83	0.71	0.85	1	1.25	30	-	2	3#12, 1#12G, 3/4"C
3A	P-4	-	30.00	40.00	33.20	28.22	34.00	3	50	60	-	3	3#6, 1#10G, 1"C
3B	TE-1	-	0.75	1.40	1.16	0.99	1.19	1	1.6	30	-	2	3#12, 1#12G, 3/4"C
3C	EF-9	-	0.50	1.00	0.83	0.71	0.85	1	1.25	30	-	2	3#12, 1#12G, 3/4"C
3D	SPACE	-	-	-	-	-	-	-	-	-	-	2	-
3E	SPACE	-	-	-	-	-	-	-	-	-	-	2	-
3F	SPACE	-	-	-	-	-	-	-	-	-	-	1	-
TOTAL:		-	102.25	162.40	134.79	114.57	138.04					36	

NOTES:
 (1) PROVIDE NEW FUSES FOR BOILERS IN SPACES MADE VACANT BY REMOVAL OF EXISTING BOILERS.
 (2) EXISTING SWITCHES MAY BE REUSED IF ADEQUATE FOR NEW INSTALLATION. CLEAN AND INSPECT EXISTING SWITCHES DURING DEMOLITION.
 (3) NEW BOILERS CONTAIN INTEGRAL VFDS. STARTERS ARE NOT REQUIRED FOR NEW BOILERS. REMOVE EXISTING BOILER STARTERS DURING DEMOLITION.
 (4) PROVIDE NEW WIRING FOR CONNECTIONS TO BOILERS. WIRING AND CONDUIT ASSOCIATED WITH EMERGENCY POWER OFF SYSTEM MAY BE RETAINED FOR REUSE.

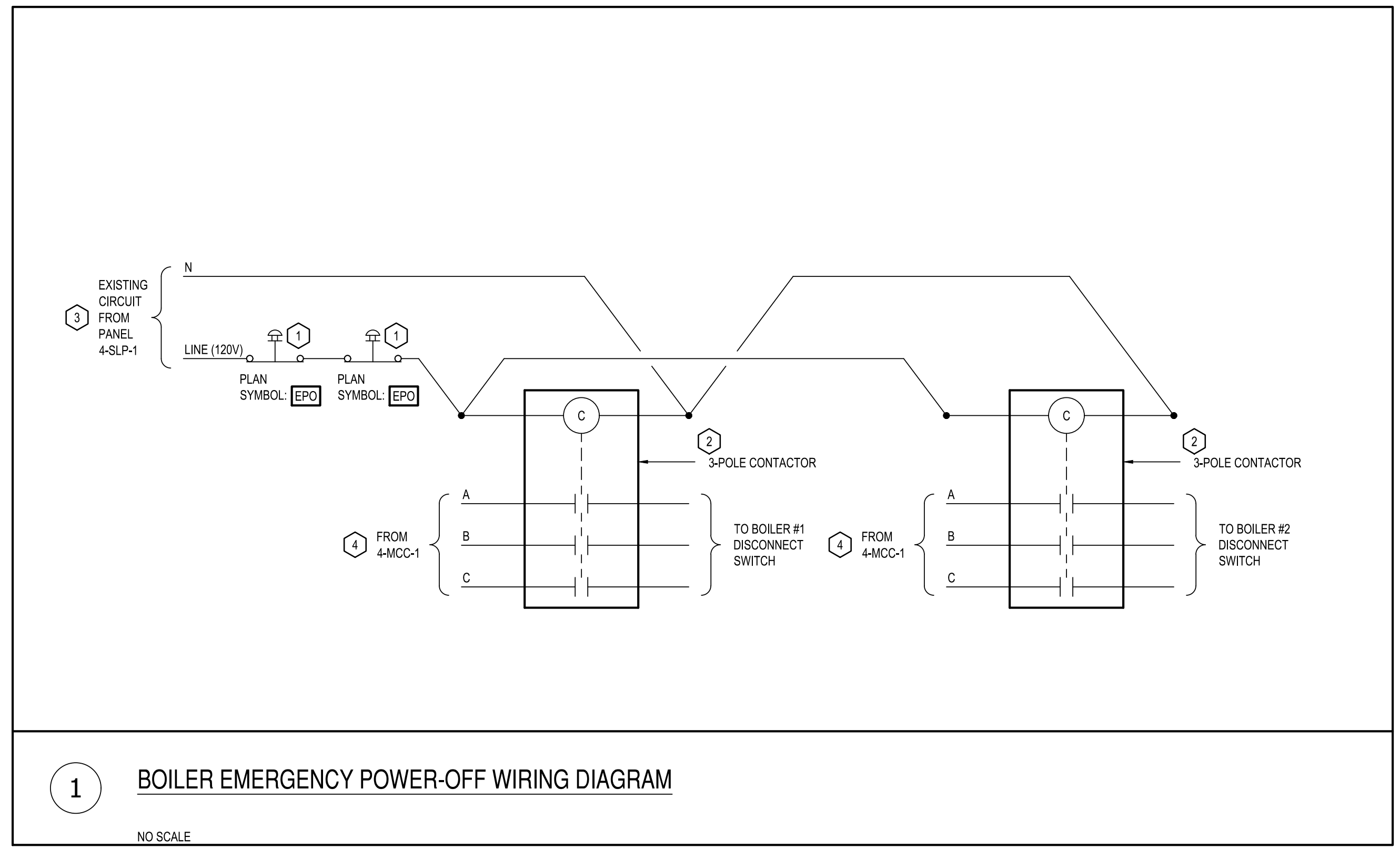

PANEL: 4-SLP-1

LOAD DESCRIPTION	LOAD TYPE	NOTE	VOLT-AMPS			CKT	BKR/POLE	A B C	BKR/POLE	CKT	VOLT-AMPS			NOTE	LOAD TYPE	LOAD DESCRIPTION
			A	B	C						A	B	C			
FPB-305		1	0	0	0	1	201	**	301	2	0	0	0	1		S-1 COMPRESSOR
FPB-306		1	0	0	0	3	201	**	201	4	0	0	0	1		S-2 COMPRESSOR
FPB401		1	0	0	0	5	201	**	201	6	0	0	0	1		MBC-1 - RM. 419
BMS FLR. 3 & 4 - RM. 419		1	0	0	0	7	201	**	201	8	0	0	0	1		MBC-1 - RM. 419
BMS FLR. 2 - RM. 203		1	0	0	0	9	201	**	201	10	0	0	0	1		MBC-1 - RM. 419
BMS FLR. 1 - RM. 203		1	0	0	0	11	201	**	201	12	0	0	0	1		EXISTING LOAD
BMS GARAGE - RM. 2		1	0	0	0	13	201	**	201	14	996	0	0	1	E	UH-30, AHU-1, D-AHU1-A, D-AHU1-B
BMS GARAGE - RM. 4		1	0	0	0	15	201	**	201	16	100	0	0	1	E	BOILER EPO SYSTEM
SPARE		1	0	0	0	17	201	**	201	18	0	0	0	1		SPARE

BREAKER NOTES		CONNECTED PHASE LOADS		LOAD TYPES CONNECTED		DEMAND	
1) THERMAL MAGNETIC	TOTAL OA =	996 VA	LIGHTING (L) =	0	0		
2) SHUNT TRIP	TOTAL OB =	100 VA	RECEPTACLES (R) =	0	0		
3) LOCK-OUT DEVICE	TOTAL OC =	0 VA	MOTORS (M) =	0	0		
4) GFCI			ELECTRIC HEATING (H) =	0	0		
5) AFCI			EQUIPMENT (E) =	1096	876.8		
6) HACR			PANELS (P) =	0	0		
7) EXISTING BREAKER	TOTAL VA =	1096	876.8				
	TOTAL AMPS =	3.0	2.4				

EQUIPMENT

TAG	EQUIPMENT	LOAD				FED FROM				CONDUIT AND CABLE	DISCONNECT				REMARKS
		VOL/Hz	CAPACITY (KW)	FULL LOAD (AMPS)	MOTOR RATED POWER (HP)	SOURCE NAME	CIRCUIT BREAKER (AMP-POLE)	SWITCH SIZE (AMP-POLE)	FUSE SIZE (AMPS)		SWITCH SIZE (AMP-POLE)	FUSE SIZE (AMP-POLE)	NEMA ENCLOSURE	FURNISHED BY	
B-1	BOILER #1	480/3/60	*	12	*	4-MCC-1	*	30-3	15	3#12, 1#12G, 3/4"C	30-3	*	1	ELEC	REUSE EXISTING EMERGENCY POWER OFF SYSTEM FOR EMERGENCY SHUTDOWN OF BOILER.
B-2	BOILER #2	480/3/60	*	12	*	4-MCC-1	*	30-3	15	3#12, 1#12G, 3/4"C	30-3	*	1	ELEC	REUSE EXISTING EMERGENCY POWER OFF SYSTEM FOR EMERGENCY SHUTDOWN OF BOILER.
D-AHU1-A	DAMPER	120/1/60	*	0.15	*	4-SLP-1	20-1	*	*	2#12, 1#12G, 3/4"C	20-1 (NOTE 2)	*	1	ELEC	*
D-AHU1-B	DAMPER	120/1/60	*	0.15	*	4-SLP-1	20-1	*	*	2#12, 1#12G, 3/4"C	20-1 (NOTE 2)	*	1	ELEC	*
AHU1	AIR HANDLING UNIT	120/1/60	*	5.8	1/4	4-SLP-1	20-1	*	*	2#12, 1#12G, 3/4"C	20-1 (NOTE 2)	*	1	ELEC	*
UH-30	UNIT HEATER, RM. 437	120/1/60	*	2.2	1/12	4-SLP-1	20-1	*	*	2#12, 1#12G, 3/4"C	20-1 (NOTE 2)	5-1 (NOTE 1)	1	ELEC	MOP FOR UNIT HEATER IS 5 AMPERES.

NOTES:
 (1) MAXIMUM ALLOWABLE OVERCURRENT PROTECTION (MOP) FOR UNIT HEATER PER MANUFACTURERS DATA IS 5 AMPERES. IF 5 AMPERE CIRCUIT BREAKER IS AVAILABLE FOR THE SUPPLY PANEL, FUSED DISCONNECT SWITCH IS NOT REQUIRED. FUSED DISCONNECT SWITCH IS REQUIRED IF PROTECTIVE DEVICE IN PANEL EXCEEDS 5 AMPERES.
 (2) PROVIDE MOTOR RATED TOGGLE SWITCH.

U:\Projects\2022\1142-0001\1142-0001-001.dwg, 11/15/2022, 10:23:59 AM, 2022/11/15/2022

April 28, 2023

John Devaney
 Manager
 Evanston Public Library
 1703 Orrington Avenue
 Evanston, IL 60201

Re: City of Evanston
 EPL Boiler Replacement
 GBA #P22-1142-00

Dear John:

Grumman|Butkus has reviewed copies of the bids received by the City of Evanston for the boiler replacement project at the Evanston Public Library at 1703 Orrington, Evanston, IL. The following table summarizes the bids.

TABLE 1: SUMMARY OF BIDS

COMPANY	ADDRESS	BASE BID AMOUNT	ALLOWANCE	BID AMOUNT WITH ALLOWANCE
Anchor Mechanical, Inc.	255 N California Ave, Chicago, IL 60612	\$497,250	10%	\$546,975
Autumn Construction Services, Inc.	87 Eisenhower Lane South, Lombard, IL 60148	\$632,000	10%	\$694,500
Core Mechanical, Inc.	4632 W Lawrence Avenue, Chicago, IL 60630	\$577,145	\$57,714	\$634,859
Key West Metal Industries	13831 S Kostner Ave, Crestwood, IL 60445	\$456,046	10%	\$501,650
Reed Construction	600 W. Jackson Blvd, Suite 800, Chicago, IL 60661	\$615,000	\$10,000	\$625,000
Voris Mechanical	370 Windy Point Drive, Glendale Heights, IL 60139	\$543,100	10%	\$597,410

It is our understanding that the City of Evanston does not want to consider the low bidder, Key West Metal Industries, over concerns about their ability to complete the project scope. We do not have any previous experience with Key West Metal and therefore we can make no recommendation regarding this contractor.

The next low bidders are Anchor Mechanical at \$546,975 and Voris Mechanical at \$597,410. We have had previous experience with both of these contractors and consider both as qualified for this project. We have had more recent experience with Voris on a number of municipal projects we have worked on recently and consider Voris highly qualified.

Sincerely,



John Tsingas PE
 Vice President